



LÍNEA 70



**LA MÁS COMPLETA
DE LAS PROFESIONALES PEQUEÑAS**



CONJUNTO LÍNEA 70

LÍNEA 70



**BAÑO MARÍA
ELÉCTRICO**

BM-74EM



**CUECEPASTAS
A GAS**

CP-74G



**SARTÉN BASCULANTE
ELÉCTRICA**

BR50-78ETF/F



FRY-TOP ELÉCTRICO

FTLT-712ETS



BARBACOA ELÉCTRICA

PCW-74G



**COCINA WOK
A GAS**

PCW-74G



MARMITA ELÉCTRICA

PI50-78ET



**ELEVADOR CESTAS
CUECEPASTAS**

SCCP-72EM

LÍNEA 70



**CUECEPASTAS ELÉCTRICO
CON ELEVADOR CESTAS**
CPA-74ET+S CCP-72EM



**FREIDORA DOBLE
A GAS**
F2/13-78G



**FREIDORA DOBLE
A GAS**
F2/8-74G



**COCINA A GAS
CON SISTEMA AGUA**
CFA4-78GP



**COCINA VITROCERÁMICA
CON HORNO**
CFC4-78ET



**COCINA
ELÉCTRICA**
CFQ4-78ET



BARBACOA ELÉCTRICA
CWT-78ET



**FREIDORA DOBLE
ELÉCTRICA**
F2/8T-74ET

LÍNEA 70

LÍNEA 70



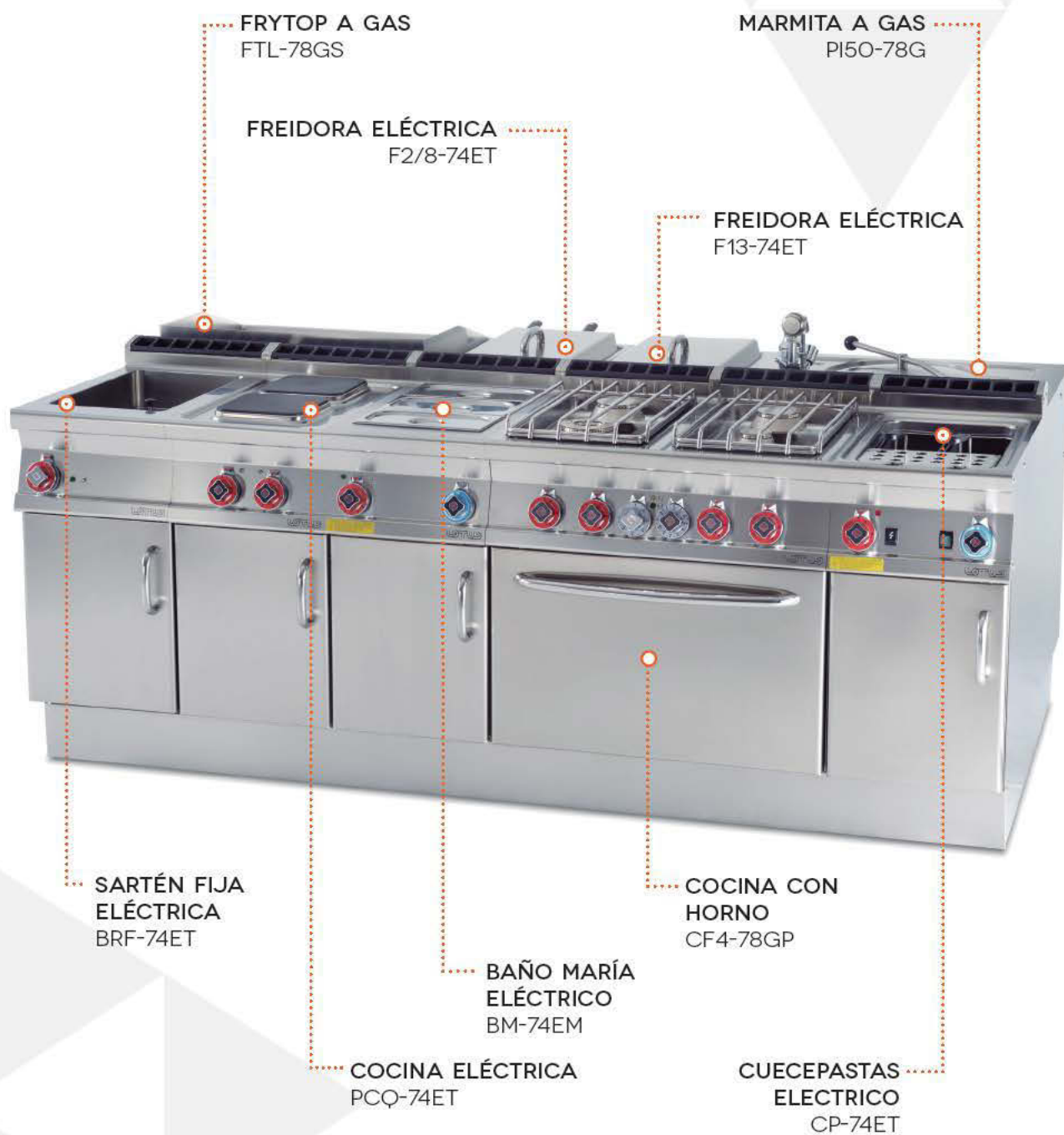







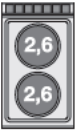

INFOGRAFÍA CONJUNTO CENTRAL LÍNEA 70





SUPERLOTUS 70 TOP

MOD. COD.	DESCRIZIONE/DESCRIPTION/BEZEICHNUNG/DESCRIPTION/DESCRIPCIÓN DIMENSIONI/DIMENSIONS/ABMESSUNGEN/DIMENSIONS/DIMENSIONES	PREZZO/PRICE PREIS/PRIX/PRECIO € KG / M ³
PLT-72 18010200	PIANO LAVORO • Worktop • Arbeitsplatte • Plan de travail • Sobre de trabajo cm. 20x70,5x28h	432,00 15 / 0,1
PLST-74 18010401	PIANO LAVORO • Worktop • Arbeitsplatte • Plan de travail • Sobre de trabajo cm. 40x70,5x28h	473,00 22 / 0,18
PLST-76 18010601	PIANO LAVORO • Worktop • Arbeitsplatte • Plan de travail • Sobre de trabajo cm. 60x70,5x28h	616,00 27 / 0,28
PLST-78 18010801	PIANO LAVORO • Worktop • Arbeitsplatte • Plan de travail • Sobre de trabajo cm. 80x70,5x28h	702,00 33 / 0,35
PLT-74 18010400	PIANO LAVORO Cassetto con 1 bacinella GN 1/1 15h plastica • Worktop - Drawer with 1 plastic container GN 1/1 15h • Arbeitsplatte - Schublade mit 1 GN 1/1 15h Kunststoffbehälter • Plan de travail - Tiroir avec bac en plastique GN 1/1 15h • Sobre de trabajo Cajón con 1 contenedor GN 1/1 15h plástico cm. 40x70,5x28h	669,00 26 / 0,18
PLT-76 18010600	PIANO LAVORO Cassetto con 1 bacinella: cm. 49x50x15h inox • Worktop Drawer with 1 container: cm. 49x50x15h inox • Arbeitsplatte Schublade mit 1 Behältern: cm. 49x50x15h inox • Plan de travail Tiroir avec 1 bac: cm. 49x50x15h inox • Sobre de trabajo Cajón con 1 contenedore: cm. 49x50x15h inox cm. 60x70,5x28h	834,00 36 / 0,28
PLT-78 18010800	PIANO LAVORO Cassetto con 2 bacinelle GN 1/1 15h plastica • Worktop - Drawer with 2 plastic containers GN 1/1 15h • Arbeitsplatte - Schublade mit 2 GN 1/1 15h Kunststoffbehältern • Plan de travail - Tiroir avec 2 bacs en plastique GN 1/1 15h • Sobre de trabajo Cajón con 2 contenedores GN 1/1 15h plástico cm. 80x70,5x28h	942,00 43 / 0,35
LAT-74 18020400	LAVELLO Rubinetto a leva - Vasca cm. 30x35x15h • Sink unit - Lever type tap - Bowl cm. 30x35x15h • Spülbecken - Einhebel-Mischbatterie Becken cm. 30x35x15h • Bac-évier avec robinetterie - Bac cm 30x35x15h • Fregadero - Grifo a palanca - Pileta cm. 30x35x15h cm. 40x70,5x28h	856,00 22 / 0,18





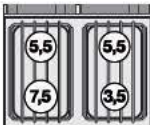

SUPERLOTUS 70 TOP

MOD. / COD.	DESCRIZIONE / DESCRIPTION / BEZEICHNUNG / DESCRIPTION / DESCRIPCIÓN DIMENSIONI / DIMENSIONS / ABMESSUNGEN / DIMENSIONS / DIMENSIONES	POTENZA / POWER / LEISTUNG / PUISSANCE / POTENCIA VOLTAGGIO / VOLTAGE / SPANNUNG / VOLTAGE / VOLTAJE	⚡ kW kcal/h V~ Hz	⚡ kW V~ Hz	PREZZO / PRICE PREIS / PRX / PRECIO € KG / M ³
PCT-74ET 18030430	PIANO COTTURA TRIFASE - N. 2 piastre • Boiling unit threephase - N. 2 plates • Kochplatte dreiphasig - N. 2 Kochplatten • Rechaud électriques - N. 2 plaques • Sobre de cocción trifásico - N. 2 planchas cm. 40x70,5x28h		⚡ 5,2 kW 400V~2N 230V~3 230V~ 50/60 Hz	⚡ 5,2 kW 400V~2N 230V~3 230V~ 50/60 Hz	721,00 26 / 0,18 
PCT-78ET 18030830	PIANO COTTURA TRIFASE N. 4 piastre • Boiling unit threephase - N. 4 plates • Kochplatte dreiphasig - N. 4 Kochplatten • Rechaud électriques - N. 4 plaques • Sobre de cocción trifásico - N. 4 planchas cm. 80x70,5x28h		⚡ 10,4 kW 400V~3N 230V~3 50/60 Hz	⚡ 10,4 kW 400V~3N 230V~3 50/60 Hz	1.141,00 63 / 0,35 
PCT-712ET 18031230	PIANO COTTURA TRIFASE N. 6 piastre • Boiling unit threephase - N. 6 plates • Kochplatte dreiphasig - N. 6 Kochplatten • Rechaud électriques - N. 6 plaques • Sobre de cocción trifásico - N. 6 planchas cm. 120x70,5x28h		⚡ 15,6 kW 400V~3N 230V~3 50/60 Hz	⚡ 15,6 kW 400V~3N 230V~3 50/60 Hz	1.825,00 82 / 0,51 
PCQT-74ET 18030431	PIANO COTTURA TRIFASE - N. 2 piastre quadre • Boiling unit threephase - N. 2 square plates • Kochplatte dreiphasig - N. 2 quadratischen Platten • Rechaud électriques - N. 2 plaques carrés • Sobre de cocción trifásico - N. 2 planchas cuadradas cm. 40x70,5x28h		⚡ 5,2 kW 400V~2N 230V~3 230V~ 50/60 Hz	⚡ 5,2 kW 400V~2N 230V~3 230V~ 50/60 Hz	1.241,00 30 / 0,18 
PCQT-78ET 18030831	PIANO COTTURA TRIFASE - N. 4 piastre quadre • Boiling unit threephase - N. 4 square plates • Kochplatte dreiphasig - N. 4 quadratischen Platten • Rechaud électriques - N. 4 plaques carrés • Sobre de cocción trifásico - N. 4 planchas cuadradas cm. 80x70,5x28h		⚡ 10,4 kW 400V~3N 230V~3 50/60 Hz	⚡ 10,4 kW 400V~3N 230V~3 50/60 Hz	1.212,00 66 / 0,35 
PCQT-712ET 18031231	PIANO COTTURA TRIFASE - N. 6 piastre quadre • Boiling unit threephase - N. 6 square plates • Kochplatte dreiphasig - N. 6 quadratischen Platten • Rechaud électriques - N. 6 plaques carrés • Sobre de cocción trifásico - N. 6 planchas cuadradas cm. 120x70,5x28h		⚡ 15,6 kW 400V~3N 230V~3 50/60 Hz	⚡ 15,6 kW 400V~3N 230V~3 50/60 Hz	3.289,00 97 / 0,51 
PCCT-74ET 18030432	PIANO COTTURA VETROCERAMICA TRIFASE - N. 2 zone - vetro cm.35x57 • Ceramic glass boiling unit - n. 2 zones - glass cm.35x57 • Ceran-Kochplatte dreiphasig - 2 zonen - Glas 35x57 cm • Plan de cuisson à vitroceramique triphasé N. 2 zones - Verre cm.35x57 • Sobre de cocción trifásico vitrocerámica - 2 zonas - vidrio cm.35x57 cm. 40x70,5x28h		⚡ 5 kW 400V~2N 230V~3 230V~ 50/60 Hz	⚡ 5 kW 400V~2N 230V~3 230V~ 50/60 Hz	1.545,00 35 / 0,18 
PCCT-78ET 18030832	PIANO COTTURA VETROCERAMICA TRIFASE - N. 4 zone - vetro cm.75x57 • Ceramic glass boiling unit - n. 4 zones - glass cm.75x57 • Ceran-Kochplatte dreiphasig - 4 zonen - Glas 75x57 cm • Plan de cuisson à vitroceramique triphasé N. 4 zones - Verre cm.75x57 • Sobre de cocción trifásico vitrocerámica - 4 zonas - vidrio cm.75x57 cm. 80x70,5x28h		⚡ 10 kW 400V~3N 230V~3 50/60 Hz	⚡ 10 kW 400V~3N 230V~3 50/60 Hz	2.343,00 62 / 0,35 

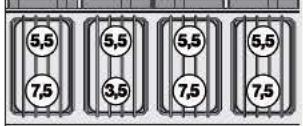
SUPERLOTUS 70 TOP

MOD. COD.	DESCRIZIONE/DESCRIPTION/BEZEICHNUNG/DESCRIPTION/DESCRIPCIÓN DIMENSIONI/DIMENSIONS/ABMESSUNGEN/DIMENSIONS/DIMENSIONES	POTENZA/POWER/LEISTUNG/PUISSANCE/POTENCIA VOLTAGGIO/VOLTAGE/SPANNUNG/VOLTAGE/VOLTAGE	⚡ kW kcal/h	⚡ kw V~ Hz	PREZZO/PRICE € PREIS/PRIX/PRECIO € KG / M ³
PCIT-74ET 18030433	PIANO COTTURA INDUZIONE TRIFASE - N. 2 zone - Vetro cm.35x57 (non posizionare su forni o cassettiere) • Three-phase induction cooking - 2 zones - glass cm.35x57 (do not place on ovens or drawers) • Induktions-Kochplatte dreiphasig - 2 zonen - Glas 35x57 cm (nicht Platz auf Öfen oder Schubladen) • Plan de cuisson à induction triphasé N. 2 zones - Verre cm.35x57 (ne placez pas sur des fours ou des tiroirs) • Encimera inducción trifásica - 2 zonas - Vidrio cm.35x57 (No coloque en los hornos o en los cajones) cm. 40x70,5x28h		⚡ 10 kW 400V~3 50/60 Hz		6.691,00 34 / 0,18
PCIT-74ETD 18030438	Comandi digitali • Digital controls / • Digitale Steuerungen • Commandes numériques / • Controles digitales				7.181,00 34 / 0,18
PCIWT-74ET 18030434	PIANO COTTURA INDUZIONE TRIFASE "WOK" - N. 1 zona - Vetro Ø 30 cm. (non posizionare su forni o cassettiere) • Three-phase induction cooking "WOK" - 1 zone - glass Ø 30 cm (do not place on ovens or drawers) • Induktions-Kochplatte "WOK" dreiphasig - 1 zonen - Glas Ø 30 cm (nicht Platz auf Öfen oder Schubladen) • Plan de cuisson à induction "WOK" triphasé N. 1 zone - Verre cm Ø 30 (ne placez pas sur des fours ou des tiroirs) • Encimera inducción "WOK" trifásica - 1 zona - Vidrio Ø 30 cm (No coloque en los hornos o en los cajones) cm. 40x70,5x28h		⚡ 5 kW 400V~3 50/60 Hz		5.032,00 32 / 0,18
PCIWT-74ETD 18030439	Comandi digitali • Digital controls / • Digitale Steuerungen • Commandes numériques / • Controles digitales				5.276,00 32 / 0,18
PCIT-78ET 18030833	PIANO COTTURA INDUZIONE TRIFASE - N. 4 zone - Vetro cm.75x57 (non posizionare su forni o cassettiere) • Three-phase induction cooking - 4 zones - glass cm.75x57 (do not place on ovens or drawers) • Induktions-Kochplatte dreiphasig - 4 zonen - Glas 75x57 cm (nicht Platz auf Öfen oder Schubladen) • Plan de cuisson à induction triphasé N. 4 zones - Verre cm.75x57 (ne placez pas sur des fours ou des tiroirs) • Encimera inducción trifásica - 4 zonas - Vidrio cm.75x57 (No coloque en los hornos o en los cajones) cm. 80x70,5x28h		⚡ 20 kW 400V~3 50/60 Hz		12.532,00 66 / 0,35
PCIT-78ETD 18030838	Comandi digitali • Digital controls / • Digitale Steuerungen • Commandes numériques / • Controles digitales				13.511,00 66 / 0,35
PCT-74GP 18210450	PIANO COTTURA GAS 2 fuochi • Gas heated boiling - 2 burners • Gas-Kochplatte - 2 Kochstellen • Rechaud gaz - 2 feux vifs • Sobres de cocción gas - 2 quemadores cm. 40x70,5x28h		⚡ 13 kW 11.180 kcal/h		1.168,00 60 / 0,18
PCT-78GP 18210850	PIANO COTTURA GAS 4 fuochi • Gas heated boiling unit - 4 burners • Gas-Kochplatte - 4 Kochstellen • Rechaud gaz - 4 feux vifs • Sobres de cocción gas - 4 quemadores cm. 80x70,5x28h		⚡ 22 kW 18.920 kcal/h	 	2.017,00 73 / 0,35

SUPERLOTUS 70 TOP

MOD. COD.	DESCRIZIONE/DESCRIPTION/BEZEICHNUNG/DESCRIPTION/DESCRIPCIÓN DIMENSIONI/DIMENSIONS/ABMESSUNGEN/DIMENSIONS/DIMENSIONES	POTENZA/POWER/LEISTUNG/PUISSANCE/POTENCIA VOLTAGGIO/VOLTAGE/SPANNUNG/VOLTAGE/VOLTAJE	⚡ kW kcal/h	⚡ kW V~ Hz	PREZZO/PRICE € PREIS/PRIX/PRECIO € KG / M ³
PCT-712GP 18211250	PIANO COTTURA GAS 6 fuochi • Gas heated boiling unit - 6 burners • Gas-kochplatte - 6 Kochstellen • Rechaud gaz - 6 feux vifs • Sobres de cocción gas - 6 quemadores cm. 120x70,5x28h		⚡ 35 kW 30.100 kcal/h		2.899,00 119 / 0,51
PCT-716GP 18211650	PIANO COTTURA GAS 8 fuochi • Gas heated boiling unit - 8 burners • Gas-kochplatte - 8 Kochstellen • Rechaud gaz - 8 feux vifs • Sobres de cocción gas - 8 quemadores cm. 160x70,5x28h		⚡ 44 kW 37.840 kcal/h		3.906,00 146 / 0,68
PCWT-74G 18210454	PIANO COTTURA GAS "WOK" 1 fuoco - fiamma verticale - ANELLO WOK • Gas heated boiling "WOK" - 1 burner - vertical flame - Wok ring • Gas-Kochplatte "WOK" - 1 Kochstellen - vertikaler Flamme - Wok Aufsatzring • Rechaud gaz "WOK" - 1 feux vifs - verticale de la flamme - Anneau Wok • Sobres de cocción gas "WOK" - 1 quemador - llama vertical - Anillo Wok cm. 40x70,5x28h		⚡ 10 kW 8.600 kcal/h		1.968,00 63 / 0,18
PAT-78G 18210851	"PAELLERO" GAS • "PAELLERO" Gas • "PAELLERO" Gas • "PAELLERO" gaz • "PAELLERO" gas cm. 80x70,5x28h		⚡ 11,5 kW 9.890 kcal/h		2.422,00 127 / 0,35
TPT-74G 18290450	TUTTA PIASTRA Piastra cm 37x57 • Solid top - Plate 37x57 cm • Kochplatte - Platte 37x57 cm • Toute plaque - Plaque cm 37x57 • Placa de cocción - Placa cm 37x57 cm. 40x70,5x28h		⚡ 7 kW 6.020 kcal/h		1.547,00 60 / 0,18
TPT-78G 18290850	TUTTA PIASTRA Piastra cm 77x57 • Solid top - Plate 77x57 cm • Kochplatte - Platte 77x57 cm • Toute plaque - Plaque cm. 77x57 • Placa de cocción - Placa cm 77x57 cm. 80x70,5x28h		⚡ 12 kW 10.320 kcal/h		2.132,00 149 / 0,35
TPT-78ET 18120830	TUTTA PIASTRA Piastra cm. 70x50 - 4 zone • Solid top - Plate cm. 70x50 - 4 zones • Kochplatten - Platte cm. 70x50 - 4 zones • Toute plaque - Plaque cm. 70x50 - 4 zones • Placa de cocción - Placa cm. 70x50 - 4 zonas cm. 80x70,5x28h		⚡ 10 kW 400V~3N 50/60 Hz		2.641,00 116 / 0,35

SUPERLOTUS 70 TOP

MOD. COD.	DESCRIZIONE/DESCRIPTION/BEZEICHNUNG/DESCRIPTION/DESCRIPCIÓN DIMENSIONI/DIMENSIONS/ABMESSUNGEN/DIMENSIONS/DIMENSIONES	POTENZA/POWER/LEISTUNG/PUISSANCE/POTENCIA VOLTAGGIO/VOLTAGE/SPANNUNG/VOLTAGE/VOLTAJE	$\frac{kW}{kcal/h}$ $\frac{kw}{V\sim}$ $\frac{Hz}{}$	PREZZO/PRICE PREIS/PRIX/PRECIO € KG / M ³
TP2T-78GP 18300850	TUTTA PIASTRA + 2 FUOCHI - Piastra cm 37x57 <ul style="list-style-type: none"> Solid top + 2 burners - Plate 37x57cm Kochplatte + 2 Gaskochstellen - Platte 37x57 cm Toute plaque + 2 brûleurs - Plaque cm 37x57 Placa de cocción + 2 fuegos - Placa cm 37x57 cm. 80x70,5x28h 		$\frac{20}{17.200}$	2.466,00 158 / 0,35
				
TP2T-712GP 18291250	TUTTA PIASTRA + 2 FUOCHI Piastra cm. 77x57 <ul style="list-style-type: none"> Solid top + 2 burners - Plate 77x57 cm Kochplatte + 2 Gaskochstellen - Platte 77x57 cm Toute plaque + 2 brûleurs - Plaque cm. 77x57 Placa de cocción + 2 fuegos - Placa cm. 77x57 cm. 120x70,5x28h 		$\frac{25}{21.500}$	3.112,00 175 / 0,51
				
TP4T-712GP 18301250	TUTTA PIASTRA + 4 FUOCHI Piastra cm. 37x57 <ul style="list-style-type: none"> Solid top + 4 burners - Plate 37x57cm Kochplatte + 4 Gaskochstellen - Platte 37x57 cm Toute plaque + 4 brûleurs - Plaque cm. 37x57 Placa de cocción + 4 fuegos - Placa cm. 37x57 cm. 120x70,5x28h 		$\frac{29}{24.940}$	3.373,00 202 / 0,51
				
BMT-74EM 18050410	BAGNOMARIA MONOFASE Vasca per GN 1/1 h.15 <ul style="list-style-type: none"> Bain marie singlephase - Bowl for GN 1/1 h.15 Wasserbäder einphasig - Becken GN 1/1 h.15 Bain marie monophasé - Cuve GN 1/1 h.15 Baño de maría monofásico - Cuba para GN 1/1 15h cm. 40x70,5x28h 		$\frac{2,1}{230V\sim}$ $\frac{50/60}{Hz}$	1.056,00 35 / 0,18
				
BMT-74G 18220450	BAGNOMARIA GAS Vasca per GN 1/1 h.15 <ul style="list-style-type: none"> Gas bain-marie - Bowl for GN 1/1 h.15 Gas Wasserbad - Becken GN 1/1 h.15 Bain-marie gaz - Cuve pour GN 1/1 h.15 Baño de maría gas - Cuba para GN 1/1 15h cm. 40x70,5x28h 		$\frac{3,5}{3.010}$	1.353,00 43 / 0,18
				
BMT-78ET 18050830	BAGNOMARIA TRIFASE Vasca per GN 2/1 15h <ul style="list-style-type: none"> Bain marie threephase - Bowl for GN 2/1 15h Wasserbäder dreiphasig - Becken GN 2/1 15h Bain marie triphase - Cuve GN 2/1 15h Baño de maría trifásico - Cuba para GN 2/1 15h cm. 80x70,5x28h 		$\frac{4,2}{400V\sim 2N}$ $\frac{230V\sim 3}{50/60}$	1.431,00 54 / 0,35
				
BMT-78G 18220850	BAGNOMARIA GAS Vasca per GN 2/1 h.15 <ul style="list-style-type: none"> Gas bain-marie - Bowl for GN 2/1 h.15 Gas Wasserbad - Becken GN 2/1 h.15 Bain-marie gaz - Cuve pour GN 2/1 h.15 Baño de maría gas - Cuba para GN 2/1 15h cm. 80x70,5x28h 		$\frac{6,5}{5.590}$	1.855,00 61 / 0,35
				

SUPERLOTUS 70 TOP

MOD. _____ DESCRIZIONE/DESCRIPTION/BEZEICHNUNG/DESCRIPTION/DESCRIPCIÓN POTENZA/POWER/LEISTUNG/PUISSANCE/POTENCIA PREZZO/PRICE €
 COD. _____ DIMENSIONI/DIMENSIONS/ABMESSUNGEN/DIMENSIONS/DIMENSIONES VOLTAGGIO/VOLTAGE/SPANNUNG/VOLTAGE/VOLTAJE kcal/h $\frac{kW}{V}$ PREIS/PRD./PRECIO €
 KG / M³

BST-74EM
18040410

CONTENITORE CALDO CON INFRAROSSO MONOFASE
 Vasca cm. 30,5x51x16,5h con falsofondo forato
 • Fry dump singlephase with infra-red heater. Bowl cm. 30,5x51x16,5h with perforated double bottom
 • Frittenwanne Einphasig mit Infrarot-strahler. Becke cm. 30,5x51x16,5h mit gelochtem Bodenrost
 • Silo a frites monophasé avec infrarouge. Cuve cm 30,5x51x16,5h avec double-fond perforé.
 • **Contenedor caliente por infrarrojo monofásico. Cuba cm. 30,5x51x16,5h con falso fondo agujereado cm. 40x70,5x28h**



1,47 kW
230V~
50/60 Hz

1.384,00
36 / 0,18

CPT-74ET
18100430

CUOCIPASTA TRIFASE LT. 17 - Vasca cm. 31x33,5x22h (per GN 2/3) Rubinetto scarico
 • Pasta cooker threephase 17 lts. Tank cm. 31x33,5x22h (for GN 2/3) Drain-tap
 • Nudelkocher dreiphasig lt.17 Becken cm. 31x33,5x22h (für GN 2/3) Ablasshahn
 • Cuiseur à pâtes triphase lt.17 Cuve cm. 31x33,5x22h (pour GN 2/3) Robinet de vidange
 • **Cucece pasta trifásico lt.17 Cuba cm. 31x33,5x22h (para GN 2/3) Grifo descarga cm. 40x70,5x28h**



5 kW
400V~3N
230V~
50/60 Hz

1.540,00
35 / 0,180

COMBINAZIONI
 • Combinations / • Zusammenstellungen
 • Combinaisons / • **Combinación múltiple**



CPT-76ET
18100630

CUOCIPASTA TRIFASE LT. 25 - Vasca cm. 51x31x22h (per GN 1/1) Rubinetto scarico
 • Pasta cooker threephase 25 lts. Tank (for GN 1/1) Drain-tap
 • Nudelkocher dreiphasig lt.25 Becken (für GN 1/1) Ablasshahn
 • Cuiseur à pâtes triphase lt.25 Cuve (pour GN 1/1) Robinet de vidange
 • **Cucece pasta trifásico lt.25 Cuba (para GN 1/1) Grifo descarga cm. 60x70,5x28h**

7,5 kW
400V~3N
50/60 Hz

1.761,00
45 / 0,270

COMBINAZIONI
 • Combinations / • Zusammenstellungen
 • Combinaisons / • **Combinación múltiple**



CPT-74G
18270450

CUOCIPASTA A GAS CAPACITA' LT. 13
 Vasca cm. 31x33,5x18h (per GN 2/3) Rubinetto scarico
 • Gas pasta cookers Tank capacity 13 lts. Tank cm. 31x33,5x18h (for GN 2/3) Drain-tap
 • Gas -Nudelkocher Beckeninhalte lt.13 Becken cm. 31x33,5x18h (für GN 2/3) Ablasshahn
 • Cuiseur à pâtes gaz Cuve lt.13 Cuve cm. 31x33,5x18h (pour GN 2/3) Robinet de vidange
 • **Cucece pasta gas Cuba 13 lt. Cuba cm. 31x33,5x18h (para GN 2/3) Grifo descarga cm. 40x70,5x28h**



6 kW
5.160 kcal/h

1.613,00
38 / 0,18

COMBINAZIONI
 • Combinations / • Zusammenstellungen
 • Combinaisons / • **Combinación múltiple**



CPT-76G
18270650

CUOCIPASTA A GAS CAPACITA' LT. 19
 Vasca cm. 51x31x18h (per GN 1/1) Rubinetto scarico
 • Gas pasta cookers Tank capacity 19 lts. Tank cm. 51x31x18h (for GN 1/1) Drain-tap
 • Gas -Nudelkocher Beckeninhalte lt. 19 Becken cm. 51x31x18h (für GN 1/1) Ablasshahn
 • Cuiseur à pâtes gaz Cuve lt.19 Cuve cm. 51x31x18h (pour GN 1/1) Robinet de vidange
 • **Cucece pasta gas Cuba 19 lt. Cuba cm. 51x31x18h (para GN 1/1) Grifo descarga cm. 60x70,5x28h**











9 kW
7.740 kcal/h

1.906,00
48 / 0,27







COMBINAZIONI
 • Combinations / • Zusammenstellungen
 • Combinaisons / • **Combinación múltiple**



SUPERLOTUS 70 TOP









MOD. COD.	DESCRIZIONE/DESCRIPTION/BEZEICHNUNG/DESCRIPTION/DESCRIPCIÓN DIMENSIONI/DIMENSIONS/ABMESSUNGEN/DIMENSIONS/DIMENSIONES	POTENZA/POWER/LEISTUNG/PUISSANCE/POTENCIA VOLTAGGIO/VOLTAGE/SPANNUNG/VOLTAGE/VOLTAGE	$\frac{kW}{kcal/h}$ $\frac{V}{Hz}$	PREZZO/PRICE € PREIS/PRIX/PRECIO € KG / M ³
FTLT-74ET 18060431 	FRY-TOP LISCIO TRIFASE Piastra cm. 36x51 • Fry-top smooth griddle threephase Plate cm. 36x51 • Griddleplatte glatt dreiphasig Platte cm. 36x51 • Plaque lisse triphase Plaque . 36x51 • Fry-top liso trifásico Plancha cm. 36x51		$\frac{5,55 kW}{400V\sim 3N}$ $\frac{230V\sim 3}{50/60 Hz}$	1.443,00 58 / 0,16
FRT-74ET 18060433 	FRY-TOP RIGATO TRIFASE Piastra cm. 36x51 • Fry-top grooved griddle threephase Plate cm. 36x51 • Griddleplatte gerillt dreiphasig Platte cm. 36x51 • Plaque nervurée triphase Plaque . 36x51 • Fry-top estriado trifásico Plancha cm. 36x51			1.557,00 58 / 0,16
FTLT-74ETS 18060434 	FRY-TOP LISCIO CROMATO TRIFASE Piastra cm. 36x51 • Fry-top chromed smooth griddle threephase Plate cm. 36x51 • Griddleplatte glatt hartverchromt dreiphasig Platte cm. 36x51 • Plaque lisse chromée triphase Plaque . 36x51 • Fry-top liso cromado trifásico Plancha cm. 36x51			1.694,00 58 / 0,16
FRT-74ETS 18060436 	FRY-TOP RIGATO CROMATO TRIFASE Piastra cm. 36x51 • Fry-top grooved chromed griddle threephase Plate cm. 36x51 • Griddleplatte gerillt hartverchromt dreiphasig Platte cm. 36x51 • Plaque nervurée chromée triphase Plaque . 36x51 • Fry-top estriado cromado trifásico Plancha cm. 36x51 cm. 40x70,5x20h			1.805,00 58 / 0,16
FTLT-74G 18230451 	FRY-TOP LISCIO GAS Piastra cm. 36x51 • Fry-top smooth griddle gas Plate cm. 36x51 • Gas-Griddleplatte glatt Platte cm. 36x51 • Plaque lisse gaz Plaque . 36x51 • Fry-top liso gas Plancha cm. 36x51		$\frac{7 kW}{6.020 kcal/h}$	1.446,00 63 / 0,16
FRT-74G 18230453 	FRY-TOP RIGATO GAS Piastra cm. 36x51 • Fry-top grooved griddle gas Plate cm. 36x51 • Gas-Griddleplatte gerillt Platte cm. 36x51 • Plaque nervurée gaz Plaque . 36x51 • Fry-top estriado gas Plancha cm. 36x51			1.603,00 63 / 0,16
FTLT-74GS 18230454 	FRY-TOP LISCIO CROMATO GAS Piastra cm. 36x51 • Fry-top chromed smooth griddle gas Plate cm. 36x51 • Gas-Griddleplatte glatt hartverchromt Platte cm. 36x51 • Plaque lisse chromée gaz Plaque . 36x51 • Fry-top liso cromado gas Plancha cm. 36x51			1.799,00 63 / 0,16
FRT-74GS 18230456 	FRY-TOP RIGATO CROMATO GAS Piastra cm. 36x51 • Fry-top grooved chromed griddle gas Plate cm. 36x51 • Gas-Griddleplatte gerillt hartverchromt Platte cm. 36x51 • Plaque nervurée chromée gaz Plaque . 36x51 • Fry-top estriado cromado gas Plancha cm. 36x51 cm. 40x70,5x28h			1.959,00 63 / 0,16

SUPERLOTUS 70 TOP

MOD. COD.	DESCRIZIONE/DESCRIPTION/BEZEICHNUNG/DESCRIPTION/DESCRIPCIÓN DIMENSIONI/DIMENSIONS/ABMESSUNGEN/DIMENSIONES	POTENZA/POWER/LEISTUNG/PUISSANCE/POTENCIA VOLTAGGIO/VOLTAGE/SPANNUNG/VOLTAGE/VOLTAJE	6kW kcal/h	7kW V~ Hz	PREZZO/PRICE PREIS/PRIZ/PRECIO €/KG / M³
FTLT-76ET 18060631 	FRY-TOP LISCIO TRIFASE Piastra cm. 56x51 • Fry-top smooth threephase Plate cm. 56x51 • Griddleplatte glatt dreiphasig Platte cm. 56x51 • Plaque lisse triphase Plaque cm. 56x51 • Fry-top trifásico Plancia cm. 56x51		7,4 kW	400V~3N 50/60 Hz	1.651,00 67 / 0,27
FTLRT-76ET 18060632 	FRY-TOP 1/2 L + 1/2 R TRIFASE Piastra cm. 56x51 • Fry-top 1/2 sm. + 1/2 gr. threephase Plate cm. 56x51 • Griddleplatte 1/2 glatt + 1/2 gerillt dreiphasig Platte cm. 56x51 • Plaque 1/2 lisse + 1/2 nervurée triphase Plaque cm. 56x51 • Fry-top 1/2 liso + 1/2 estriado trifásico Plancia cm. 56x51				1.780,00 67 / 0,27
FTRT-76ET 18060633 	FRY-TOP RIGATO TRIFASE Piastra cm. 56x51 • Fry-top grooved threephase Plate cm. 56x51 • Griddleplatte gerillt dreiphasig Platte cm. 56x51 • Plaque nervurée triphase Plaque cm. 56x51 • Fry-top estriado trifásico Plancia cm. 56x51				1.909,00 67 / 0,27
FTLT-76ETS 18060634 	FRY-TOP LISCIO CROMATO TRIFASE Piastra cm. 56x51 • Fry-top chrome smooth threephase Plate cm. 56x51 • Griddleplatte glatt hartverchromt dreiphasig Platte cm. 56x51 • Plaque lisse chromée triphase Plaque cm. 56x51 • Fry-top liso cromado trifásico Plancia cm. 56x51				2.067,00 67 / 0,27
FTLRT-76ETS 18060635 	FRY-TOP 1/2 L + 1/2 R CROMATO TRIFASE Piastra cm. 56x51 • Fry-top 1/2 sm. + 1/2 gr. chrome threephase Plate cm. 56x51 • Griddleplatte 1/2 glatt + 1/2 gerillt hartverchromt dreiphasig Platte cm. 56x51 • Plaque 1/2 lisse + 1/2 nervurée chromée triphase Plaque cm. 56x51 • Fry-top 1/2 liso + 1/2 estriado cromado trifásico Plancia cm. 56x51				2.191,00 67 / 0,27
FTRT-76ETS 18060636 	FRY-TOP RIGATO CROMATO TRIFASE Piastra cm. 56x51 • Fry-top grooved chrome griddle threephase Plate cm. 56x51 • Griddleplatte gerillt hartverchromt dreiphasig Platte cm. 56x51 • Plaque nervurée chromée triphase Plaque cm. 56x51 • Fry-top estriado cromado trifásico Plancia cm. 56x51 cm. 60x70,5x28h				2.323,00 67 / 0,27









SUPERLOTUS 70 TOP

MOD. COD.	DESCRIZIONE/DESCRIPTION/BEZEICHNUNG/DESCRIPTION/DESCRIPCIÓN DIMENSIONI/DIMENSIONS/ABMESSUNGEN/DIMENSIONES/DIMENSIONES	POTENZA/POWER/LEISTUNG/PUISSANCE/POTENCIA VOLTAGGIO/VOLTAGE/SPANNUNG/VOLTAGE/VOLTAGE	⚡ kW kcal/h	⚡ kw V~ Hz	PREZZO/PRICE € PREIS/PRIX/PRECIO € KG / M ³
FTLI-76G 18230651 	FRY-TOP LISCIO GAS Piastra cm. 56x51 • Fry-top smooth gas Plate cm. 56x51 • Gas-griddleplatte glatt Platte cm. 56x51 • Plaque lisse gaz Plaque cm. 56x51 • Fry-top liso gas Plancia cm. 56x51		10,5 kW 9.030 kcal/h		1.771,00 68 / 0,27
FTLRT-76G 18230652 	FRY-TOP 1/2 LISCIO +1/2 RIGATO GAS Piastra cm. 56x51 • Fry-top 1/2 sm. + 1/2 gr. gas Plate cm. 56x51 • Gas-griddleplatte 1/2 glatt +1/2 gerillt Platte cm. 56x51 • Plaque 1/2 lisse + 1/2 nervurée gaz Plaque cm. 56x51 • Fry-top 1/2 liso + 1/2 estriado gas Plancia cm. 56x51				1.897,00 68 / 0,27
FRT-76G 18230653 	FRY-TOP RIGATO GAS Piastra cm. 56x51 • Fry-top grooved griddle-gas Plate cm. 56x51 • Gas-griddleplatte gerillt Platte cm. 56x51 • Plaque nervurée gaz Plaque cm. 56x51 • Fry-top estriado gas Plancia cm. 56x51				2.024,00 68 / 0,27
FTLI-76GS 18230654 	FRY-TOP LISCIO CROMATO GAS Piastra cm. 56x51 • Fry-top sm. chrome griddle-gas Plate cm. 56x51 • Gas-griddleplatte glatt hartverchromt Platte cm. 56x51 • Plaque lisse chromée gaz Plaque cm. 56x51 • Fry-top liso cromado gas Plancia cm. 56x51				2.207,00 68 / 0,27
FTLRT-76GS 18230655 	FRY-TOP 1/2 LISCIO +1/2 RIGATO CROMATO GAS Piastra cm. 56x51 • Fry-top 1/2 sm. + 1/2 gr. chrome griddle gas Plate cm. 56x51 • Gas-griddleplatte 1/2 gl + 1/2 ge hartverchromt Platte cm. 56x51 • Plaque 1/2 lisse + 1/2 nervurée chromée gaz Plaque cm. 56x51 • Fry-top 1/2 liso + 1/2 estriado cromado gas Plancia cm. 56x51				2.335,00 68 / 0,27
FRT-76GS 18230656 	FRY-TOP RIGATO CROMATO GAS Piastra cm. 56x51 • Fry-top grooved chrome griddle gas Plate cm. 56x51 • Gas-griddleplatte gerillt hartverchromt Platte cm. 56x51 • Plaque nervurée chromée gaz Plaque cm. 56x51 • Fry-top estriado cromado gas Plancia cm. 56x51 cm. 60x70,5x28h				2.463,00 68 / 0,27
FTLI-78ET 18060831 	FRY-TOP LISCIO TRIFASE Piastra cm. 76x51 - 2 zone di cottura • Fry-top smooth griddle threephase Plate cm. 76x51 - 2 cooking areas • Griddleplatte glatt dreiphasig Platte cm. 76x51 - 2 Heizzonen • Plaque lisse triphase Plaque cm. 76x51 - 2 zones de cuisson • Fry-top liso trifásico Plancha cm. 76x51 - 2 zonas de cocción			11,1 kW 400V~3N 230V~3 50/60 Hz	2.144,00 103 / 0,35
FTLRT-78ET 18060832 	FRY-TOP 1/2 LISCIO + 1/2 RIGATO TRIFASE Piastra cm. 76x51 - 2 zone di cottura • Fry-top 1/2 smooth + 1/2 grooved griddle threephase Plate cm. 76x51 - 2 cooking areas • Griddleplatte 1/2 glatt + 1/2 gerillt dreiphasig Platte cm. 76x51 - 2 Heizzonen • Plaque 1/2 lisse + 1/2 nervurée triphase Plaque cm. 76x51 - 2 zones de cuisson • Fry-top 1/2 liso + 1/2 estriado trifásico Plancha cm. 76x51 - 2 zonas de cocción				2.312,00 103 / 0,35
FRT-78ET 18060833 	FRY-TOP RIGATO TRIFASE Piastra cm. 76x51 - 2 zone di cottura • Fry-top grooved griddle threephase Plate cm. 76x51 - 2 cooking areas • Griddleplatte gerillt dreiphasig Platte cm. 76x51 - 2 Heizzonen • Plaque nervurée triphase Plaque cm. 76x51 - 2 zones de cuisson • Fry-top estriado trifásico Plancha cm. 76x51 - 2 zonas de cocción cm. 80x70,5x28h				2.439,00 103 / 0,35







SUPERLOTUS 70 TOP

MOD. COD.	DESCRIZIONE / DESCRIPTION / BEZEICHNUNG / DESCRIPTION / DESCRIPCIÓN DIMENSIONI / DIMENSIONS / ABMESSUNGEN / DIMENSIONS / DIMENSIONES	POTENZA / POWER / LEISTUNG / PUISSANCE / POTENCIA VOLTAGGIO / VOLTAGE / SPANNUNG / VOLTAGE / VOLTAJE	6 kW kcal/h kw V~ Hz	PREZZO / PRICE € PREIS / PRD / PRECIO KG / M ²
FTLT-78ETS 18060834	<p>FRY-TOP LISCIO CROMATO TRIFASE</p> <p>Piastra cm. 76x51 - 2 zone di cottura</p> <ul style="list-style-type: none"> Fry-top chromed smooth griddle threephase Plate cm. 76x51 - 2 cooking areas Griddleplatte glatt hartverchromt dreiphasig Platte cm. 76x51 - 2 Heizzonen Plaque lisse chromée triphase Plaque cm. 76x51 - 2 zones de cuisson <p>Fry-top liso cromado trifásico Plancha cm. 76x51 - 2 zonas de cocción</p>		11,1 kW 400V~3N 230V~3 50/60 Hz	2.675,00 103 / 0,35
FTLRT-78ETS 18060835	<p>FRY-TOP 1/2 LISCIO + 1/2 RIGATO CROMATO TRIFASE</p> <p>Piastra cm. 76x51 - 2 zone di cottura</p> <ul style="list-style-type: none"> Fry-top 1/2 smooth + 1/2 grooved griddle threephase Plate cm. 76x51 - 2 cooking areas Griddleplatte 1/2 glatt + 1/2 gerillt dreiphasig Platte cm. 76x51 - 2 Heizzonen Plaque 1/2 lisse + 1/2 nervurée triphase Plaque cm. 76x51 - 2 zones de cuisson <p>Fry-top 1/2 liso + 1/2 estriado trifásico Plancha cm. 76x51 - 2 zonas de cocción</p>			2.837,00 103 / 0,35
FTRT-78ETS 18060836	<p>FRY-TOP RIGATO CROMATO TRIFASE</p> <p>Piastra cm. 76x51 - 2 zone di cottura</p> <ul style="list-style-type: none"> Fry-top grooved chromed griddle threephase Plate cm. 76x51 - 2 cooking areas Griddleplatte gerillt hartverchromt dreiphasig Platte cm. 76x51 - 2 Heizzonen Plaque nervurée chromée triphase Plaque cm. 76x51 - 2 zones de cuisson <p>Fry-top estriado cromado trifásico Plancha cm. 76x51 - 2 zonas de cocción cm. 80x70,5x28h</p>			2.996,00 103 / 0,35
FTLT-78G 18230851	<p>FRY-TOP LISCIO GAS</p> <p>Piastra cm. 76x51 - 2 zone di cottura</p> <ul style="list-style-type: none"> Fry-top smooth griddle gas Plate cm. 76x51 - 2 cooking areas Gas-Griddleplatte glatt Platte cm. 76x51 - 2 Heizzonen Plaque lisse gaz Plaque cm. 76x51 - 2 zones de cuisson <p>Fry-top liso gas Plancha cm. 76x51 - 2 zonas de cocción</p>		14 kW 12.040 kcal/h	2.610,00 108 / 0,35
FTLRT-78G 18230852	<p>FRY-TOP 1/2 LISCIO + 1/2 RIGATO GAS</p> <p>Piastra cm. 76x51 - 2 zone di cottura</p> <ul style="list-style-type: none"> Fry-top 1/2 smooth + 1/2 grooved griddle gas Plate cm. 76x51 - 2 cooking areas Gas-Griddleplatte 1/2 glatt + 1/2 gerillt Platte cm. 76x51 - 2 Heizzonen Plaque 1/2 lisse + 1/2 nervurée gaz Plaque cm. 76x51 - 2 zones de cuisson <p>Fry-top 1/2 liso + 1/2 estriado gas Plancha cm. 76x51 - 2 zonas de cocción</p>			2.763,00 108 / 0,35
FTRT-78G 18230853	<p>FRY-TOP RIGATO GAS</p> <p>Piastra cm. 76x51 - 2 zone di cottura</p> <ul style="list-style-type: none"> Fry-top grooved griddle gas Plate cm. 76x51 - 2 cooking areas Gas-Griddleplatte gerillt Platte cm. 76x51 - 2 Heizzonen Plaque nervurée gaz Plaque cm. 76x51 - 2 zones de cuisson <p>Fry-top estriado gas Plancha cm. 76x51 - 2 zonas de cocción</p>			2.915,00 108 / 0,35
FTLT-78GS 18230854	<p>FRY-TOP LISCIO CROMATO GAS</p> <p>Piastra cm. 76x51 - 2 zone di cottura</p> <ul style="list-style-type: none"> Fry-top chromed smooth griddle gas Plate cm. 76x51 - 2 cooking areas Gas-Griddleplatte glatt hartverchromt Platte cm. 76x51 - 2 Heizzonen Plaque lisse chromée triphase Plaque cm. 76x51 - 2 zones de cuisson <p>Fry-top liso cromado gas Plancha cm. 76x51 - 2 zonas de cocción</p>			3.253,00 108 / 0,35
FTLRT-78GS 18230855	<p>FRY-TOP 1/2 LISCIO + 1/2 RIGATO CROMATO GAS</p> <p>Piastra cm. 76x51 - 2 zone di cottura</p> <ul style="list-style-type: none"> Fry-top 1/2 smooth + 1/2 grooved chromed griddle threephase Plate cm. 76x51 - 2 cooking areas Gas-Griddleplatte 1/2 glatt + 1/2 gerillt hartverchromt Platte cm. 76x51 - 2 Heizzonen Plaque 1/2 lisse + 1/2 nervurée chromée gaz Plaque cm. 76x51 - 2 zones de cuisson <p>Fry-top 1/2 liso + 1/2 estriado cromado gas Plancha cm. 76x51 - 2 zonas de cocción</p>			3.404,00 108 / 0,35
FTRT-78GS 18230856	<p>FRY-TOP RIGATO CROMATO GAS</p> <p>Piastra cm. 76x51 - 2 zone di cottura</p> <ul style="list-style-type: none"> Fry-top grooved chromed griddle gas Plate cm. 76x51 - 2 cooking areas Gas-Griddleplatte gerillt hartverchromt Platte cm. 76x51 - 2 Heizzonen Plaque nervurée chromée gaz Plaque cm. 76x51 - 2 zones de cuisson <p>Fry-top estriado cromado gas Plancha cm. 76x51 - 2 zonas de cocción cm. 80x70,5x28h</p>			3.556,00 108 / 0,35

SUPERLOTUS 70 TOP



MOD. COD.	DESCRIZIONE/DESCRIPTION/BEZEICHNUNG/DESCRIPTION/DESCRIPCIÓN DIMENSIONI/DIMENSIONS/ABMESSUNGEN/DIMENSIONS/DIMENSIONES	POTENZA/POWER/LEISTUNG/PUISSANCE/POTENCIA VOLTAGGIO/VOLTAGE/SPANNUNG/VOLTAGE/VOLTAGE	kw kcal/h	kw V~ Hz	PREZZO/PRICE € PREIS/PRIX/PRECIO € KG / M ³
FTLT-712ET 18061231	 FRY-TOP LISCIO TRIFASE Piastra cm. 116x51 - 2 zone di cottura <ul style="list-style-type: none"> • Threephase smooth griddle Plate cm. 116x51 - 2 cooking areas • Griddleplatte glatt dreiphasig Platte cm. 116x51 - 2 Heizzonen • Plaque lisse triphase Plaque cm. 116x51 - 2 zones de cuisson Fry-top liso trifásico Plancha cm. 116x51 - 2 zonas de cocción		14,8 KW	400V~3N 50/60 Hz	3.036,00 114 / 0,51
FTLRT-712ET 18061232	 FRY-TOP 1/2 LISCIO + 1/2 RIGATO TRIFASE Piastra cm. 116x51 - 2 zone di cottura <ul style="list-style-type: none"> • Threephase 1/2 smooth + 1/2 grooved griddle Plate cm. 116x51 - 2 cooking areas • Griddleplatte 1/2 glatt + 1/2 gerillt dreiphasig Platte cm. 116x51 - 2 Heizzonen • Plaque 1/2 lisse + 1/2 nervurée triphase Plaque cm. 116x51 - 2 zones de cuisson Fry-top 1/2 liso + 1/2 estriado trifásico Plancha cm. 116x51 - 2 zonas de cocción				3.187,00 114 / 0,51
FTRT-712ET 18061233	 FRY-TOP RIGATO TRIFASE Piastra cm. 116x51 - 2 zone di cottura <ul style="list-style-type: none"> • Threephase grooved griddle Plate cm. 116x51 - 2 cooking areas • Griddleplatte gerillt dreiphasig Platte cm. 116x51 - 2 Heizzonen • Plaque nervurée triphase Plaque cm. 116x51 - 2 zones de cuisson Fry-top estriado trifásico Plancha cm. 116x51 - 2 zonas de cocción				3.346,00 114 / 0,51
FTLT-712ETS 18061234	 FRY-TOP LISCIO CROMATO TRIFASE Piastra cm. 116x51 - 2 zone di cottura <ul style="list-style-type: none"> • Threephase chromed smooth griddle Plate cm. 116x51 - 2 cooking areas • Griddleplatte glatt hartverchromt dreiphasig Platte cm. 116x51 - 2 Heizzonen • Plaque lisse chromée triphase Plaque cm. 116x51 - 2 zones de cuisson Fry-top liso cromado trifásico Plancha cm. 116x51 - 2 zonas de cocción				3.783,00 114 / 0,51
FTLRT-712ETS 18061235	 FRY-TOP 1/2 LISCIO + 1/2 RIGATO CROMATO TRIFASE Piastra cm. 116x51 - 2 zone di cottura <ul style="list-style-type: none"> • Threephase 1/2 smooth + 1/2 grooved chromed griddle Plate cm. 116x51 - 2 cooking areas • Griddleplatte 1/2 glatt + 1/2 gerillt hartverchromt dreiphasig Platte cm. 116x51 - 2 Heizzonen • Plaque 1/2 lisse + 1/2 nervurée chromée triphase Plaque cm. 116x51 - 2 zones de cuisson Fry-top 1/2 liso + 1/2 estriado cromado trifásico Plancha cm. 116x51 - 2 zonas de cocción				4.012,00 114 / 0,51
FTRT-712ETS 18061236	 FRY-TOP RIGATO CROMATO TRIFASE Piastra cm. 116x51 - 2 zone di cottura <ul style="list-style-type: none"> • Threephase grooved chromed griddle Plate cm. 116x51 - 2 cooking areas • Griddleplatte gerillt hartverchromt dreiphasig Platte cm. 116x51 - 2 Heizzonen • Plaque nervurée chromée triphase Plaque cm. 116x51 - 2 zones de cuisson Fry-top estriado cromado trifásico Plancha cm. 116x51 - 2 zonas de cocción cm. 120x70,5x28h				4.307,00 114 / 0,51

SUPERLOTUS 70 TOP







MOD. COD.	DESCRIZIONE/DESCRIPTION/BEZEICHNUNG/DESCRIPTION/DESCRIPCIÓN DIMENSIONI/DIMENSIONS/ABMESSUNGEN/DIMENSIONS/DIMENSIONES	POTENZA/POWER/LEISTUNG/PUISSANCE/POTENCIA VOLTAGGIO/VOLTAGE/SPANNUNG/VOLTAGE/VOLTAJE	$\frac{\text{kW}}{\text{kcal/h}}$ / $\frac{\text{kw}}{\text{V-}} / \frac{\text{Hz}}{\text{Hz}}$	PREZZO/PRICE € PREIS/PRIX/PRECIO € KG / M³
FTLT-712G 18231251 	FRY-TOP LISCIO GAS Piastra cm. 116x51 - 2 zone di cottura • Gas smooth griddle Plate cm. 116x51 - 2 cooking areas • Gas-Griddleplatte glatt Platte cm. 116x51 - 2 Heizzonen • Plaque lisse gaz Plaque cm. 116x51 - 2 zones de cuisson • Fry-top liso gas Plancha cm. 116x51 - 2 zonas de cocción		$\frac{21 \text{ kW}}{18.060 \text{ kcal/h}}$	3.455,00 120 / 0,51
FTLRT-712G 18231252 	FRY-TOP 1/2 LISCIO + 1/2 RIGATO GAS Piastra cm. 116x51 - 2 zone di cottura • Gas 1/2 smooth + 1/2 grooved griddle Plate cm. 116x51 - 2 cooking areas • Gas-Griddleplatte 1/2 glatt + 1/2 gerillt Platte cm. 116x51 - 2 Heizzonen • Plaque 1/2 lisse + 1/2 nervurée gaz Plaque cm. 116x51 - 2 zones de cuisson • Fry-top 1/2 liso + 1/2 estriado gas Plancha cm. 116x51 - 2 zonas de cocción			3.639,00 120 / 0,51
FTRT-712G 18231253 	FRY-TOP RIGATO GAS Piastra cm. 116x51 - 2 zone di cottura • Gas grooved griddle Plate cm. 116x51 - 2 cooking areas • Gas-Griddleplatte gerillt Platte cm. 116x51 - 2 Heizzonen • Plaque nervurée gaz Plaque cm. 116x51 - 2 zones de cuisson • Fry-top estriado gas Plancha cm. 116x51 - 2 zonas de cocción			3.826,00 120 / 0,51
FTLT-712GS 18231254 	FRY-TOP LISCIO CROMATO GAS Piastra cm. 116x51 - 2 zone di cottura • Gas chromed smooth griddle Plate cm. 116x51 - 2 cooking areas • Gas-Griddleplatte glatt hartverchromt Platte cm. 116x51 - 2 Heizzonen • Plaque lisse chromée triphase Plaque cm. 116x51 - 2 zones de cuisson • Fry-top liso cromado gas Plancha cm. 116x51 - 2 zonas de cocción			4.120,00 120 / 0,51
FTLRT-712GS 18231255 	FRY-TOP 1/2 LISCIO + 1/2 RIGATO CROMATO GAS Piastra cm. 116x51 - 2 zone di cottura • Gas 1/2 smooth + 1/2 grooved chromed griddle Plate cm. 116x51 - 2 cooking areas • Gas-Griddleplatte 1/2 glatt + 1/2 gerillt hartverchromt Platte cm. 116x51 - 2 Heizzonen • Plaque 1/2 lisse + 1/2 nervurée chromée gaz Plaque cm. 116x51 - 2 zones de cuisson • Fry-top 1/2 liso + 1/2 estriado cromado gas Plancha cm. 116x51 - 2 zonas de cocción			4.271,00 120 / 0,51
FTRT-712GS 18231256 	FRY-TOP RIGATO CROMATO GAS Piastra cm. 116x51 - 2 zone di cottura • Gas grooved chromed griddle Plate cm. 116x51 - 2 cooking areas • Gas-Griddleplatte gerillt hartverchromt Platte cm. 116x51 - 2 Heizzonen • Plaque nervurée chromée gaz Plaque cm. 116x51 - 2 zones de cuisson • Fry-top estriado cromado gas Plancha cm. 116x51 - 2 zonas de cocción cm. 120x70,5x28h			4.469,00 120 / 0,51



SUPERLOTUS 70 TOP

MOD. COD.	DESCRIZIONE/DESCRIPTION/BEZEICHNUNG/DESCRIPTION/DESCRIPCIÓN DIMENSIONI/DIMENSIONS/ABMESSUNGEN/DIMENSIONS/DIMENSIONES	POTENZA/POWER/LEISTUNG/PUISSANCE/POTENCIA VOLTAGGIO/VOLTAGE/SPANNUNG/VOLTAGE/VOLTAGE	⚡ kW kcal/h	⚡ kw V~ Hz	PREZZO/PRICE PREIS/PRIX/PRECIO € KG / M ³
FTCT-74ET 18060437 	FRY-TOP VETROCERAMICA TRIFASE Piastra cm. 36x51 • Fry-top ceramic glass threephase Plate cm. 36x51 • Griddleplatte Ceran-Kochplatten dreiphasig Platte cm. 36x51 • Plaque vitrocéramique triphase Plaque . 36x51 • Fry-top vitroceramica trifásico Plancha cm. 36x51 cm. 40x70,5x28h		2,7 kW	400V~3N 230V~3 230V~ 50/60 Hz	1.613,00 56 / 0,16
FTCT-78ET 18060837 	FRY-TOP VETROCERAMICA TRIFASE Piastra cm. 76x51 - 2 zone di cottura • Fry-top ceramic glass threephase Plate cm. 76x51 - 2 cooking areas • Griddleplatte Ceran-Kochplatten dreiphasig Platte cm. 76x51 - 2 Heizzonen • Plaque vitrocéramique triphase Plaque cm. 76x51 - 2 zones de cuisson • Fry-top vitroceramica trifásico Plancha cm. 76x51 - 2 zonas de cocción cm. 80x70,5x28h		5,4 kW	400V~3N 230V~3 230V~ 50/60 Hz	2.636,00 103 / 0,35

SUPERLOTUS 70 TOP

MOD. / COD.	DESCRIZIONE / DESCRIPTION / BEZEICHNUNG / DESCRIPTION / DESCRIPCIÓN DIMENSIONI / DIMENSIONS / ABMESSUNGEN / DIMENSIONS / DIMENSIONES	POTENZA / POWER / LEISTUNG / PUISSANCE / POTENCIA VOLTAGGIO / VOLTAGE / SPANNUNG / VOLTAGE / VOLTAJE	6 kW kcal/h	9 kW V~ Hz	PREZZO / PRICE € PREIS / PRIK / PRECIO € KG / M ³
CWT-74ET 18080430	<p>GRIGLIA TRIFASE</p> <p>Griglia in acciaio inox cm. 38x52 regolabile</p> <ul style="list-style-type: none"> • Grill threephase - Stainless steel grill cm. 38x52 • Wurstbrater dreiphasig - Einstellbarer Rost aus Nirosta cm. 38x52 • Grillade triphase - Grille inox cm 38x52 • Parrilla trifásico - Parrilla de acero inox regulable cm 38x52 cm. 40x70,5x28h 		6 kW 400V~3N 230V~3 50/60 Hz		1.659,00 57 / 0,18
CWT-74G 18250450	<p>GRIGLIA GAS-PIETRALAVICA</p> <p>Griglia in acciaio inox cm. 38x52 regolabile</p> <ul style="list-style-type: none"> • Charcoal grill gas - Stainless steel grill cm. 38x52 • Gas-Lavasteingrill - Einstellbarer Rost aus Nirosta cm. 38x52 • Grille à gaz en pierre de lave - Grille inox cm 38x52 • Parrilla a gas piedra lávica - Parrilla de acero inox regulable cm 38x52 cm. 40x70,5x28h 		9 kW 7.740 kcal/h		1.804,00 56 / 0,18
CWT-78ET 18080830	<p>GRIGLIA TRIFASE N. 2 griglie in acciaio inox cm. 38x52 regolabili 2 zone di cottura</p> <ul style="list-style-type: none"> • Grill threephase - N. 2 Stainless steel grill cm. 38x52. 2 cooking areas • Wurstbrater dreiphasig - N. 2 einstellbare Roste aus Nirosta cm. 38x52 - 2 Heizzonen • Grillade triphase - N. 2 grilles réglables en acier inox cm. 38x52 - 2 zones de cuisson • Parrilla trifásico - N. 2 Parrillas de acero inox regulable cm 38x52 - 2 zonas de cocción cm. 80x70,5x28h 		12 kW 400V~3N 230V~3 50/60 Hz		2.504,00 87 / 0,35
CWT-78G 18250850	<p>GRIGLIA GAS-PIETRALAVICA N. 2 griglie in acciaio inox cm. 38x52 regolabili 2 zone di cottura</p> <ul style="list-style-type: none"> • Charcoal grill gas - N. 2 Stainless steel grill cm. 38x52 2 cooking areas • Gas-Lavasteingrill - N. 2 einstellbare Roste aus Nirosta cm. 38x52 - 2 Heizzonen • Grille a gaz en pierre de lave - N. 2 grilles réglables en acier inox cm. 38x52 - 2 zones de cuisson • Parrilla a gas piedra lávica - N. 2 Parrillas de acero inox regulable cm 38x52 - 2 zonas de cocción cm. 80x70,5x28h 		18 kW 15.480 kcal/h		2.814,00 97 / 0,35
CWKT-74ET 18080431	<p>GRIGLIA CONTACT - cottura diretta su resistenza in acciaio inox cm. 27x43 ribaltabile</p> <ul style="list-style-type: none"> • CONTACT Grill threephase - rotabile stainless steel grill cm. 27x43 • Wurstbrater dreiphasig KONTAKT - Drehbaren Heizelement aus Edelstahl cm. 27x43 • Grillade triphase CONTACT - Grille inox rotatif cm 27x43 • Parrilla trifásico CONTACT - Parrilla giratoria de acero inox cm 27x43 cm. 40x70,5x28h 		4,08 KW 400V~3N 50/60 Hz		2.343,00 55 / 0,18
CWKT-78ET 18080831	<p>GRIGLIA CONTACT - cottura diretta su resistenza in acciaio inox cm. 55x43 ribaltabile - 2 zone cottura</p> <ul style="list-style-type: none"> • CONTACT Grill threephase - rotabile stainless steel grill cm. 55x43 - 2 cooking areas • Wurstbrater dreiphasig KONTAKT - Drehbaren Heizelement aus Edelstahl cm.. 55x43 - 2 Heizzonen • Grillade triphase CONTACT - Grille inox rotatif cm 55x43 - 2 zones de cuisson • Parrilla trifásico CONTACT - Parrilla giratoria de acero inox cm 55x43 - 2 zonas de cocción cm. 80x70,5x28h 		8,16 KW 400V~3N 50/60 Hz		3.163,00 85 / 0,35

SUPERLOTUS 70 TOP

MOD. COD.	DESCRIZIONE/DESCRIPTION/BEZEICHNUNG/DESCRIPTION/DESCRIPCIÓN DIMENSIONI/DIMENSIONS/ABMESSUNGEN/DIMENSIONS/DIMENSIONES	POTENZA/POWER/LEISTUNG/PUISSANCE/POTENCIA VOLTAGGIO/VOLTAGE/SPANNUNG/VOLTAGE/VOLTAJE	⚡ kW kcal/h	⚡ kw V~ Hz	PREZZO/PRICE € PREIS/PRIX/PRECIO € KG / M ³
F2/8T-74ET 18090432	FRIGGITRICE TRIFASE LT. 8+8 - 2 Vasche cm. 14,8x35,5x22,5h - 2 cesti cm. 12x29x11,5h Filtro e coperchio vasca. Produzione patate: 12 kg/h <ul style="list-style-type: none"> Fryer threephase 8+8 lts - 2 Bowls cm. 14,8x35,5x22,5h 2 baskets cm. 12x29x11,5h. Sieve and lid for pan. Production: 12 kg/h Friteuse dreiphasig lt. 8+8 - 2 Becken cm. 14,8x35,5x22,5h - 2 Korb cm. 12x29x11,5h. Einlegesieb und Deckel für Becken. Pommes frites: 12 kg/h Friteuse triphase lt. 8+8 - 2 Cuve cm. 14,8x35,5x22,5h 2 Panier cm. 12x29x11,5h. Filtre, couvercle pour cuve. Production de pommes frites: 12 kg/h Freidoras trifásico 8+8 lt. - 2Cuba cm. 14,8x35,5x22,5h 2 cestas cm. 12x29x11,5h. Filtro y tapa para cuba. Prod. patatas: 12 Kg/h cm. 40x70,5x28h		12 kW 400V~3N 230V~3 50/60 Hz		2.514,00 50 / 0,180
F2/8T-74G 18260452	FRIGGITRICE GAS LT. 8+8 2 vasche cm. 15x35x23h 2 cesti cm. 12x30x9,5h. Filtro e coperchio vasca. Prod. patate: 12 kg/h <ul style="list-style-type: none"> Gas Fryer 8+8 lts - 2 pans cm. 15x35x23h 2 baskets cm. 12x30x9,5h. Sieve and lid for pan. Production: 12 kg/h Gas-Friteuse lt. 8+8 - 2 Becken cm. 15x35x23h 2 Körbe cm. 12x30x9,5h. Einlegesieb und Deckel für Becken. Pommes frites: 12 kg/h Friteuse à gaz lt. 8+8 - 2 cuves cm. 15x35x23h 2 paniers cm. 12x30x9,5h. Filtre, couvercle pour cuve. Production de pommes frites: 12 kg/h Freidoras a gas 8+8 lt. - 2 cubas cm. 15x35x23h 2 cestas cm. 12x30x9,5h. Filtro y tapa para cuba. Prod. patatas: 12 Kg/h cm. 40x70,5x28h		9 kW 7.740 kcal/h		2.891,00 50 / 0,180
F13T-74ET 18090430	FRIGGITRICE TRIFASE LT. 13 Vasca cm. 30,5x34x22,5h - 1 cesto cm. 28x29x10h Filtro e coperchio vasca - Produzione patate: 10 kg/h <ul style="list-style-type: none"> Fryer threephase 13 lts - Bowl cm. 30,5x34x22,5h 1 basket cm. 28x29x10h - Sieve and lid for pan Production: 10 kg/h Friteuse dreiphasig lt. 13 - Becken cm. 30,5x34x22,5h - 1 Korb cm. 28x29x10h - Einlegesieb und Deckel für Becken - Pommes frites: 10 kg/h Friteuse triphase lt. 13 - Cuve cm. 30,5x34x22,5h - 1 Panier cm. 28x29x10h - Filtre, couvercle pour cuve Production de pommes frites: 10 kg/h Freidoras trifásico 13 lt. - Cuba cm. 30,5x34x22,5h - 1 cesta cm. 28x29x10h - Filtro y tapa para cuba. Prod. patatas: 10 Kg/h cm. 40x70,5x28h		11,95 kW 400V~3N 50/60 Hz		1.780,00 48 / 0,180
F13T-74G 18260450	FRIGGITRICE GAS LT. 13 - Vasca cm. 31,5x34,5x22,5h 1 cesto cm. 28x29x10h - Filtro e coperchio vasca. Prod. patate: 10 kg/h <ul style="list-style-type: none"> Gas Fryer 13 lts - Bowl cm. 31,5x34,5x22,5h - 1 basket cm. 28x29x10h - Sieve and lid for pan Production: 10 kg/h Gas-Friteuse lt. 13 - Becken cm. 31,5x34,5x22,5h - 1 Korb cm. 28x29x10h - Einlegesieb und Deckel für Becken - Pommes frites: 10 kg/h Friteuse à gaz lt. 13 - Cuve cm. 31,5x34,5x22,5h - 1 Panier cm. 28x29x10h - Filtre, couvercle pour cuve Production de pommes frites: 10 kg/h Freidoras a gas 13 lt. - Cuba cm. 31,5x34,5x22,5h - 1 cesta cm. 28x29x10h - Filtro y tapa para cuba Prod. patatas: 10 Kg/h cm. 40x70,5x28h		12 kW 10.320 kcal/h		1.936,00 55 / 0,180
F2/13T-78ET 18090830	FRIGGITRICE TRIFASE LT. 13+13 - 2 vasche cm. 30,5x34x22,5h - 2 cesti cm. 28x29x10h 2 filtri e coperchi vasche Produzione patate: 20 kg/h <ul style="list-style-type: none"> Fryer threephase 13+13 lts - 2 pans cm. 30,5x34x22,5h 2 baskets cm. 28x29x10h - 2 sieves and lids for pan Production: 20 kg/h Friteuse dreiphasig lt. 13+13 - 2 Becken cm. 30,5x34x22,5h 2 Körbe cm. 28x29x10h - Einlegesieb und Deckel für Becken - Pommes frites: 20 kg/h Friteuse triphase lt. 13+13 - 2 cuves cm. 30,5x34x22,5h 2 paniers cm. 28x29x10h - 2 filtres, couvercles pour cuve Production de pommes frites: 20 kg/h Freidoras trifásico 13+13 lt. - 2 cubas cm. 30,5x34x22,5h - 2 cestas cm. 28x29x10h - 2 filtros y tapas para cubas Prod. patatas: 20 Kg/h cm. 80x70,5x28h		23,9 kW 400V~3N 50/60 Hz		2.820,00 75 / 0,350

SUPERLOTUS 70 TOP

MOD. / COD. DESCRIZIONE/DESCRIPTION/BEZEICHNUNG/DESCRIPTION/DESCRIPCIÓN
DIMENSIONI/DIMENSIONS/ABMESSUNGEN/DIMENSIONS/DIMENSIONES POTENZA/POWER/LEISTUNG/PUISSANCE/POTENCIA
VOLTAGGIO/VOLTAGE/SPANNUNG/VOLTAGE/VOLTAJE kW / kcal/h PREZZO/PRICE
PREIS/PRIX/PRECIO €
KG / M³

F2/13T-78G
18260850

FRIGGITRICE GAS LT. 13+13 - 2 vasche cm. 31,5x34,5x22,5h - 2 cesti cm. 28x29x10h 2 filtri e coperchi vasche
Prod. patate: 20 kg/h

- Gas Fryer 13+13 lts - 2 pans cm. 31,5x34,5x22,5h 2 baskets cm. 28x29x10h - 2 sieves and lids for pan
Production: 20 kg/h
- Gas-Friteuse lt. 13+13 - 2 Becken cm. 31,5x34,5x22,5h 2 Körbe cm. 28x29x10h - Einlegesieb und Deckel für Becken - Pommes frites: 20 kg/h
- Friteuse à gaz lt. 13+13 - 2 cuves cm. 31,5x34,5x22,5h 2 paniers cm. 28x29x10h - 2 filtres, couvercles pour cuve
Production de pommes frites: 20 kg/h

• **Freidoras a gas 13+13 lt. - 2 cubas cm. 31,5x34,5x22,5h 2 cestas cm. 28x29x10h - 2 filtros y tapas para cubas.**
Prod. patatas: 20 Kg/h
cm. 80x70,5x28h



24 kW / 20.640 kcal/h **3.079,00**
81 / 0,350

MFV-78ET
08490830

BASE CON FORNO ELETTRICO VENTILATO GN 1/1 cm. 56x36x34h
(non sovrapporre elementi ad induzione)

- Stand with electric fan oven GN 1/1 cm. 56x36x34h (no induction top)
- Unterbau mit Elektro-Heißluftofen GN 1/1 cm. 56x36x34h (nicht Induktions)
- Placard avec Four à chaleur tournante électrique GN 1/1 cm. 56x36x34h (il faut pas de induction)

• **Mueble con Horno eléctrico ventilado GN 1/1 cm. 56x36x34h (no inducción)**
cm. 80x63x57h



5,32 kW / 400V~3N / 230V~3 / 50/60 Hz **2.884,00**
55 / 0,390

MF-710ET
08491030

Base con Forno elettrico statico GN 2/1 cm. 68x55x34h
(non sovrapporre elementi ad induzione)

- Stand with traditional electric oven GN 2/1 cm. 68x55x34h (no induction top)
- Unterbau mit Statischer Elektro-Backofen GN 2/1 cm. 68x55x34h (nicht Induktions)
- Placard avec Four électrique statique GN 2/1 cm. 68x55x34h (il faut pas de induction)

• **Mueble con Horno eléctrico estático GN 2/1 cm. 68x55x34h (no inducción)**
cm. 100x63x57h

5 kW / 400V~3N / 50/60 Hz **2.728,00**
60 / 0,55

CMF-78
08490800

COPERCHIO per MFV-78E

- Lid for MFV-78E
- Berichterstattung für MFV-78E
- Couvercle pour MFV-78E

• **Cubertura para MFV-78E**
cm. 80x62,5x2,8h



196,00
5 / 0,015

CMF-710
08491000

COPERCHIO per MF-710E

- Lid for MF-710E
- Berichterstattung für MF-710E
- Couvercle pour MF-710E

• **Cubertura para MF-710E**
cm. 100x62,5x2,8h

237,00
6 / 0,02

MPI-74
08410403

BASE CON PORTA PER INDUZIONE

- Stand with door for induction top
- Unterbau für Induktions mit Tür
- Placard pour induction avec porte

• **Mueble base para inducción con puerta**
cm. 40x62x57h



569,00
20 / 0,190

MPI-78
08410803

cm. 80x62x57h

643,00
27 / 0,340

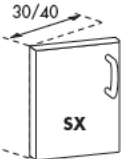
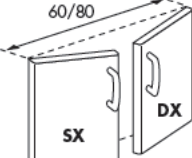
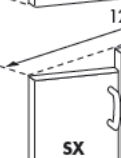
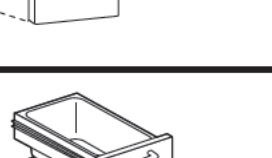
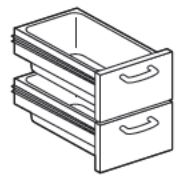
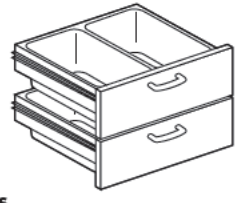

SUPERLOTUS 70 TOP

MOD. COD.	DESCRIZIONE/DESCRIPTION/BEZEICHNUNG/DESCRIPTION/DESCRIPCIÓN DIMENSIONI/DIMENSIONS/ABMESSUNGEN/DIMENSIONS/DIMENSIONES	POTENZA/POWER/LEISTUNG/PUISSANCE/POTENCIA VOLTAGGIO/VOLTAGE/SPANNUNG/VOLTAGE/VOLTAJE	kWh kcal/h	kw V~ Hz	PREZZO/PRICE PREIS/PRIX/PRECIO € KG / M ³
M-74 08410400	BASE NEUTRA • Stand • Offener Unterbau • Placard ouvert • Mueble base cm. 40x59,5x57h				355,00 17 / 0,190
M-76 08410600	cm. 60x59,5x57h				397,00 21 / 0,270
M-78 08410800	cm. 80x59,5x57h				428,00 24 / 0,340
M-712 08411200	cm. 120x59,5x57h				604,00 35 / 0,500
M-716 08411600	cm. 160x59,5x57h				721,00 52 / 0,650
PM-73/93-DX 08430302	PORTA 300 DESTRA • Right door 300 / • Rechte tür 300 • Porte droite 300 / • Puerta derecha 300 cm. 29,5x2,5x47,5h				159,00 3 / 0,005
PM-74/94-DX 08430402	PORTA 400 DESTRA • Right door 400 / • Rechte tür 400 • Porte droite 400 / • Puerta derecha 400 cm. 39,5x2,5x47,5h				165,00 3,5 / 0,006
PM-73/93-SX 08430303	PORTA 300 SINISTRA • Left door 300 / • Linke tür 300 • Porte gauche 300 / • Puerta iziquierda 300 cm. 29,5x2,5x47,5h				159,00 3 / 0,005
PM-74/94-SX 08430403	PORTA 400 SINISTRA • Left door 400 / • Linke tür 400 • Porte gauche 400 / • Puerta iziquierda 400 cm. 39,5x2,5x47,5h				165,00 3,5 / 0,006
C-74/94 08440420	CASSETTIERA 400 - N. 2 cassetti con 2 bacinelle GN 1/1 15h in plastica, guide telescopiche • Drawer set 400 - N. 2 drawers with 2 GN 1/1 15h plastic containers, telescopic guides • Schubladen - N. 2 Schubladen mit 2 GN 1/1 15h Kunststoffbehältern, Telescopeinführungen • Tiroirs pour meuble de 400 - N. 2 tiroirs avec 2 bacs en plastique GN 1/1 15h, guides télescopiques • Cajonera 400 - N. 2 cajones con 2 contenedores GN 1/1 15h de plástico, guías telescópicas cm. 39,5x59x47,5h				635,00 18 / 0,110
C-76/96 08440620	CASSETTIERA 600 - N. 2 cassetti con 2 bacinelle inox, guide telescopiche • Drawer set 600 N. 2 drawers with 2 inox containers, telescopic guides • Schubladen 600 - N. 2 Schubladen mit 2 Chromnickelstahlbehältern, Telescopeinführungen • Tiroirs pour meuble de 600 N. 2 tiroirs avec 2 bacs inox, guides télescopiques • Cajonera 600 - N. 2 cajones con 2 contenedores de acero inox, guías telescópicas cm. 59,5x59x47,5h				879,00 22 / 0,180
C-78/98 08440820	CASSETTIERA 800 - N. 2 cassetti con 4 bacinelle GN 1/1 15h in plastica, guide telescopiche • Drawer set 800 - N. 2 drawers with 4 GN 1/1 15h plastic containers, telescopic guides • Schubladen 800 - N. 2 Schubladen mit 4 GN 1/1 15h Kunststoffbehältern, Telescopeinführungen • Tiroirs pour meuble de 800 - N. 2 tiroirs avec 4 bacs en plastique GN 1/1 15h, guides télescopiques • Cajonera 800 - N. 2 cajones con 4 contenedores GN 1/1 15h de plástico, guías telescópicas cm. 79,5x59x47,5h				896,00 26 / 0,220





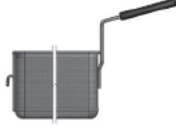

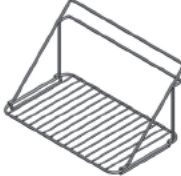





SUPERLOTUS 70 TOP

MOD. / COD.	DESCRIZIONE / DESCRIPTION / BEZEICHNUNG / DESCRIPTION / DESCRIPCIÓN DIMENSIONI / DIMENSIONS / ABMESSUNGEN / DIMENSIONS / DIMENSIONES	POTENZA / POWER / LEISTUNG / PUISSANCE / POTENCIA VOLTAGGIO / VOLTAGE / SPANNUNG / VOLTAGE / VOLTAJE	6 kW kcal/h	7 kw V~ Hz	PREZZO / PRICE € PREIS / PRIX / PRECIO € KG / M ³
D-70 08470001	DIVISORIO base neutra • Spacer for stand • Trennwand für offener unterbau • Separation pour placard ouvert • Divisorio para mueble base cm. 5x58x38h				131,00 2,5 / 0,015
PT-74/94 08460002	PORTATEGLIE VANO 400/600 (GN-1/1) 4 ripiani int. 7 cm. • Frame for plates 400/600 (GN-1/1) - N. 4 shelves, wheel-base 7 cm. • Aufhängeschienen für bleche 400/600 (GN-1/1) N. 4 Etagen, Abstand 7 cm. • Kit porte-plaques 400/600 (GN-1/1) - N. 4 étagères; 7 cm. • Portacazuelas 400/600 (GN-1/1) - N. 4 estantes, int. 7 cm.				344,00 2,5 / 0,010
PT-78/98 08460012	PORTATEGLIE VANO 800 (GN-2/1) 4 ripiani int. 7 cm. • Frame for plates 800 (GN-2/1) 4 Etagen, Abstand 7 cm. • Aufhängeschienen für bleche 800 (GN-2/1) N. 4 Etagen, Abstand 7 cm. • Kit porte-plaques 800 (GN-2/1) - N. 4 étagères; 7 cm. • Portacazuelas 800 (GN-2/1) - N. 4 estantes, int. 7 cm.				459,00 4 / 0,020
531048800	CESTO 1/2 per F13T-G/E • Basket 1/2 for F13T-G/E • Korb 1/2 zur Friteuse F13T-G/E • Panier 1/2 pour F13T-G/E • Cesta 1/2 para F13T-G/E cm. 13,5x29x 9h				72,00 0,8 / 0,02
531018800	CESTO 1/2 PER CPT-64/74 - 1/3 PER CPT-66/76 • Basket 1/2 for CPT-64/74 - 1/3 for CPT-66/76 • Korb 1/2 für CPT-64/74 - 1/3 für CPT-66/76 • Panier 1/2 pour CPT-64/74 - 1/3 pour CPT-66/76 • Cesta 1/2 para CPT-64/74 - 1/3 para CPT-66/76 cm. 14,5x29x15h				104,00 1,3 / 0,016
531053800	CESTO 1/4 PER CPT-66/76 • Basket 1/4 for CPT-66/76 • Korb 1/4 für CPT-66/76 • Panier 1/4 pour CPT-66/76 • Cesta 1/4 para CPT-66/76 cm. 11,5x29x15h				98,00 1,2 / 0,007
531040000	CESTO 1/1 PER CPT-66/76 • Basket 1/1 for CPT-66/76 • Korb 1/1 für CPT-66/76 • Panier 1/1 pour CPT-66/76 • Cesta 1/1 para CPT-66/76 cm.49x29x15h				179,00 3,5 / 0,036
531053700	CESTO 1/4 PER CPT-64/74 • Basket 1/4 for CPT-64/74 • Korb 1/4 für CPT-64/74 • Panier 1/4 pour CPT-64/74 • Cesta 1/4 para CPT-64/74 cm.14x16x15h				69,00 1 / 0,013
531053500	CESTO 1/1 PER CPT-64/74 • Basket 1/1 for CPT-64/74 • Korb 1/1 für CPT-64/74 • Panier 1/1 pour CPT-64/74 • Cesta 1/1 para CPT-64/74 cm.29x29x15h				128,00 1,5 / 0,021

SUPERLOTUS 70 TOP

MOD. COD.	DESCRIZIONE/DESCRIPTION/BEZEICHNUNG/DESCRIPTION/DESCRIPCIÓN DIMENSIONI/DIMENSIONS/ABMESSUNGEN/DIMENSIONS/DIMENSIONES	POTENZA/POWER/LEISTUNG/PUISSANCE/POTENCIA VOLTAGGIO/VOLTAGE/SPANNUNG/VOLTAGE/VOLTAJE	kW kcal/h	PREZZO/PRICE € PREIS/PRIX/PRECIO € KG / M ³
531071300	CESTO CON GANCIO 1/2 PER CPT-64/74 1/3 PER CPT-66/76 • Basket with hook 1/2 for CPT-64/74 - 1/3 for CPT-66/76 • Korb mit Haken 1/2 für CPT-64/74 - 1/3 für CPT-66/76 • Panier avec crochet 1/2 pour CPT-64/74 - 1/3 pour CPT-66/76 • Cesta con gancho 1/2 para CPT-64/74 - 1/3 para CPT-66/76 cm. 13,5x 25,5x15h			103,00 1,3 / 0,02
531071400	CESTO CON GANCIO 1/4 PER CPT-66/76 • Basket with hook 1/4 for CPT-66/76 • Korb mit Haken 1/4 für CPT-66/76 • Panier avec crochet 1/4 pour CPT-66/76 • Cesta con gancho 1/4 para CPT-66/76 cm. 11x 25,5x15h			96,00 1,2 / 0,01
531071800	GRIGLIA SUPPORTO CESTI CON GANCIO PER CPT-64/74 • Support for baskets with hook for CPT-64/74 • Unterstützung für Körbe mit Haken für CPT-64/74 • Soutien pour les paniers avec crochet pour CPT-64/74 • Soporte para cestas con gancho para CPT-64/74 cm. 30x33x25h			104,00 3 / 0,03
531071900	GRIGLIA SUPPORTO CESTI CON GANCIO PER CPT-66/76 • Support for baskets with hook for CPT-66/76 • Unterstützung für Körbe mit Haken für CPT-66/76 • Soutien pour les paniers avec crochet pour CPT-66/76 • Soporte para cestas con gancho para CPT-66/76 cm. 50x30x25h			132,00 3,5 / 0,04

SUPERLOTUS 70

MOD. / COD.	DESCRIZIONE / DESCRIPTION / BEZEICHNUNG / DESCRIPTION / DESCRIPCIÓN DIMENSIONI / DIMENSIONS / ABMESSUNGEN / DIMENSIONS / DIMENSIONES	POTENZA / POWER / LEISTUNG / PUISSANCE / POTENCIA VOLTAGGIO / VOLTAGE / SPANNUNG / VOLTAGE / VOLTAJE	6 kW kcal/h	15,4 kW 400V~3N 50/60 Hz	PREZZO / PRICE PREIS / PRIJZ / PRECIO € KG / M ³
CF4-78ET 08660830	CUCINA 4 piastre - Forno elettrico statico GN 2/1 cm. 68x55x34h <ul style="list-style-type: none"> • Electric range - N. 4 plates Traditional electric oven GN 2/1 cm. 68x55x34h • Elektroherd - N. 4 Kochplatten Statischer Elektro-Backofen GN 2/1 cm. 68x55x34h • Fourneau électrique - N. 4 plaques Four électrique statique GN 2/1 cm. 68x55x34h • Cocina eléctrica - N. 4 planchas Horno eléctrico estático GN 2/1 cm. 68x55x34h cm. 80x70,5x90h 				2.913,00 112 / 0,77
					
CFV4-78ET 08660835	CUCINA 4 piastre - Forno elettrico ventilato GN 1/1 cm. 68x36x34h <ul style="list-style-type: none"> • Electric range - N. 4 plates - electric fan oven GN 1/1 cm. 68x36x34h • Elektroherd - N. 4 Kochplatten - Elektro-Heißluftofen GN 1/1 cm. 68x36x34h • Fourneau électrique - N. 4 plaques Four à chaleur tournante électrique GN 1/1 cm. 68x36x34h • Cocina eléctrica - N. 4 planchas - Horno eléctrico ventilado GN 1/1 cm. 68x36x34h cm. 80x70,5x90h 				3.261,00 112 / 0,77
					
CFQ4-78ET 08660831	CUCINA 4 piastre quadre Forno elettrico statico GN 2/1 cm. 68x55x34h <ul style="list-style-type: none"> • Electric range - N. 4 square plates Traditional electric oven GN 2/1 cm. 68x55x34h • Elektroherd - N. 4 quadratischen Platten Statischer Elektro-Backofen GN 2/1 cm. 68x55x34h • Fourneau électrique - N. 4 plaques carrés Four électrique statique GN 2/1 cm. 68x55x34h • Cocina eléctrica - N. 4 planchas cuadradas Horno eléctrico estático GN 2/1 cm. 68x55x34h cm. 80x70,5x90h 				3.765,00 120 / 0,77
					
CFVQ4-78ET 08660836	CUCINA 4 piastre quadre Forno elettrico ventilato GN 1/1 cm. 68x36x34h <ul style="list-style-type: none"> • Electric range - N. 4 square plates - electric fan oven GN 1/1 cm. 68x36x34h • Elektroherd - N. 4 quadratischen Platten - Elektro-Heißluftofen GN 1/1 cm. 68x36x34h • Fourneau électrique - N. 4 plaques carrés Four à chaleur tournante électrique GN 1/1 cm. 68x36x34h • Cocina eléctrica - N. 4 planchas cuadradas Horno eléctrico ventilado GN 1/1 cm. 68x36x34h cm. 80x70,5x90h 				4.091,00 120 / 0,77
					
CFC4-78ET 08660832	CUCINA 4 piastre vetroceramica cm. 75x57 Forno elettrico statico GN 2/1 cm. 68x55x34h <ul style="list-style-type: none"> • Electric range N. 4 plates ceramic glass cm. 75x57 traditional electric oven GN 2/1 cm. 68x55x34h • Elektroherd N. 4 Ceran-Kochplatten cm. 75x57 Statischer Elektro-Backofen GN 2/1 cm. 68x55x34h • Fourneau électrique N. 4 plaques vitroceramique cm. 75x57 Four électrique statique GN 2/1 cm. 68x55x34h • Cocina eléctrica N. 4 planchas vitrocerámica cm. 75x57 Horno eléctrico estático GN 2/1 cm. 68x55x34h cm. 80x70,5x90h 				4.129,00 107 / 0,77
					
CFVC4-78ET 08660837	CUCINA 4 piastre vetroceramica cm. 75x57 Forno elettrico ventilato GN 1/1 cm. 68x36x34h <ul style="list-style-type: none"> • Electric range N. 4 plates ceramic glass cm. 75x57 electric fan oven GN 1/1 cm. 68x36x34h • Elektroherd N. 4 Ceran-Kochplatten cm. 75x57 Elektro-Heißluftofen GN 1/1 cm. 68x36x34h • Fourneau électrique N. 4 plaques vitroceramique cm. 75x57 Four à chaleur tournante électrique GN 1/1 cm. 68x36x34h • Cocina eléctrica N. 4 planchas vitrocerámica cm. 75x57 Horno eléctrico ventilado GN 1/1 cm. 68x36x34h cm. 80x70,5x90h 				4.442,00 107 / 0,77
					

SUPERLOTUS 70

MOD. COD.	DESCRIZIONE/DESCRIPTION/BEZEICHNUNG/DESCRIPTION/DESCRIPCIÓN DIMENSIONI/DIMENSIONS/ABMESSUNGEN/DIMENSIONS/DIMENSIONES	POTENZA/POWER/LEISTUNG/PUISSANCE/POTENCIA VOLTAGGIO/VOLTAGE/SPANNUNG/VOLTAGE/VOLTAGE	6 kW kcal/h	5 kW V- Hz	PREZZO/PRICE € PREIS/PRIX/PRECIO € KG / M ²
--------------	---	---	----------------	------------------	--

CF4-78GP 08680850	<p>CUCINA 4 fuochi - Forno a gas statico GN 2/1 cm. 68x55x34h</p> <ul style="list-style-type: none"> Gas Range - N. 4 burners Traditional gas-oven GN 2/1 cm. 68x55x34h Gasherd - N. 4 Kochstellen Statischer Gas-Backofen GN 2/1 cm. 68x55x34h Cuisiniere gaz - N. 4 feuxvifs Four à gaz statique GN 2/1 cm. 68x55x34h Cocina a gas - N. 4 quemadores Horno a gas estático GN 2/1 cm. 68x55x34h cm. 80x70,5x90h 		6 29,3 kW	5 25.198 kcal/h	3.452,00
					138 / 0,77

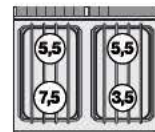

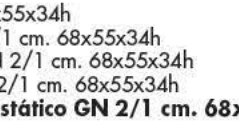
CF4-78GPE 08690860	<p>CUCINA 4 fuochi - Forno elettrico statico GN 2/1 cm. 68x55x34h</p> <ul style="list-style-type: none"> Gas Range - N. 4 burners - traditional electric oven GN 2/1 cm. 68x55x34h Gasherd - N. 4 Kochstellen Statischer Elektro-Backofen GN 2/1 cm. 68x55x34h Cuisiniere gaz - N. 4 feuxvifs Four électrique statique GN 2/1 cm. 68x55x34h Cocina a gas - N. 4 quemadores Horno eléctrico estático GN 2/1 cm. 68x55x34h cm. 80x70,5x90h 		6 22 kW	5 18.920 kcal/h	3.452,00
					132 / 0,77
			5 5 kW	400V~3N	
				50/60 Hz	

CFV4-78GPE 08690865	<p>CUCINA 4 fuochi - Forno elettrico ventilato GN 1/1 cm. 68x36x34h</p> <ul style="list-style-type: none"> Gas Range - N. 4 burners - electric fan oven GN 1/1 cm. 68x36x34h Gasherd - N. 4 Kochstellen Elektro-Heißluftofen GN 1/1 cm. 68x36x34h Cuisiniere gaz - N. 4 feuxvifs Four à chaleur tournante électrique GN 1/1 cm. 68x36x34h Cocina a gas - N. 4 quemadores Horno eléctrico ventilado GN 1/1 cm. 68x36x34h cm. 80x70,5x90h 		6 22 kW	5 18.920 kcal/h	3.785,00
					132 / 0,77
			5 5,32 kW	400V~3N	
				230V~3	
				50/60 Hz	

CFA4-78GP 08750850	<p>CUCINA ACQUA 4 fuochi - Forno a gas statico GN 2/1 cm. 68x55x34h Rubinetto carico acqua, sfioratore</p> <ul style="list-style-type: none"> Water range - N. 4 burners Traditional gas-oven GN 2/1 cm. 68x55x34h - Water loading tap + overflow device Wasser herd - N. 4 Kochstellen Statischer Gas-Backofen GN 2/1 cm. 68x55x34h - Wasserlauf-Hahn + Überlauf-Vorrichtung Cuisinière l'eau - N. 4 feuxvifs Four à gaz statique GN 2/1 cm. 68x55x34h - Robinet d'arrivée d'eau trop plein Cocina a agua - N. 4 quemadores Horno a gas estático cm. 68x55x34h - Grifo carga agua + vertedero cm. 80x70,5x90h 		6 35,3 kW	5 30.358 kcal/h	4.850,00
					138 / 0,77

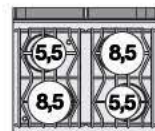

CF6-712ETV 08661230	<p>CUCINA 6 piastre - Forno elettrico statico GN 2/1 cm. 68x55x34h - Vano neutro con porta</p> <ul style="list-style-type: none"> Electric range - N. 6 plates Traditional electric oven GN 2/1 cm. 68x55x34h Neutral cabinet with door Elektroherd - N. 6 Kochplatten Statischer Elektro-Backofen GN 2/1 cm. 68x55x34h Neutrales Schrankelement mit Tür Fourneau électrique - N. 6 plaques Four électrique statique GN 2/1 cm. 68x55x34h Element neutre avec porte Cocina eléctrica - N. 6 planchas Horno eléctrico estático GN 2/1 cm. 68x55x34h Armario neutro con puerta cm. 120x70,5x90h 		5 20,6 kW	400V~3N	3.884,00
				50/60 Hz	134 / 1,14

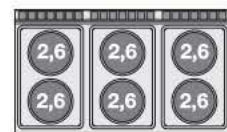

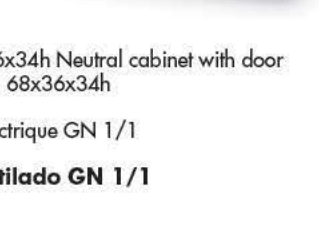
CFV6-712ETV 08661235	<p>CUCINA 6 piastre - Forno elettrico ventilato GN 1/1 cm. 68x36x34h - Vano neutro con porta</p> <ul style="list-style-type: none"> Electric range - N. 6 plates electric fan oven GN 1/1 cm. 68x36x34h Neutral cabinet with door Elektroherd - N. 6 Kochplatten Elektro-Heißluftofen GN 1/1 cm. 68x36x34h Neutrales Schrankelement mit Tür Fourneau électrique - N. 6 plaques Four à chaleur tournante électrique GN 1/1 cm. 68x36x34h Element neutre avec porte Cocina eléctrica - N. 6 planchas Horno eléctrico ventilado GN 1/1 cm. 68x36x34h Armario neutro con puerta cm. 120x70,5x90h 		5 20,92 kW	400V~3N	4.195,00
				50/60 Hz	134 / 1,14









CFQ6-712ETV 08661231	<p>CUCINA 6 piastre quadre - Forno elettrico statico GN 2/1 cm. 68x55x34h - Vano neutro con porta</p> <ul style="list-style-type: none"> Electric range - N. 6 square plates Traditional electric oven GN 2/1 cm. 68x55x34h Neutral cabinet with door Elektroherd - N. 6 quadratischen Platten Statischer Elektro-Backofen GN 2/1 cm. 68x55x34h Neutrales Schrankelement mit Tür Fourneau électrique - N. 6 plaques carrés Four électrique statique GN 2/1 cm. 68x55x34h Element neutre avec porte Cocina eléctrica - N. 6 planchas cuadradas Horno eléctrico estático GN 2/1 cm. 68x55x34h Armario neutro con puerta cm. 120x70,5x90h 		5 20,6 kW	400V~3N	5.203,00
				50/60 Hz	146 / 1,14

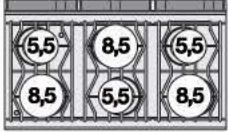

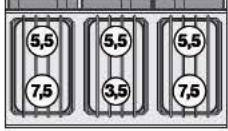
SUPERLOTUS 70

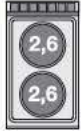
MOD. / COD.	DESCRIZIONE / DESCRIPTION / BEZEICHNUNG / DESCRIPTION / DESCRIPCIÓN / DIMENSIONI / DIMENSIONS / ABMESSUNGEN / DIMENSIONS / DIMENSIONES	POTENZA / POWER / LEISTUNG / PUISSANCE / POTENCIA / VOLTAGGIO / VOLTAGE / SPANNUNG / VOLTAGE / VOLTAJE	6 kW kcal/h 1 kW V- Hz	PREZZO / PRICE € / PREIS / PRIX / PRECIO € / KG / M ³
CFVQ6-712ETV 08661236	<p>CUCINA 6 piastre quadre - Forno elettrico ventilato GN 1/1 cm. 68x36x34h - Vano neutro con porta</p> <ul style="list-style-type: none"> Electric range - N. 6 square plates electric fan oven GN 1/1 cm. 68x36x34h Neutral cabinet with door Elektroherd - N. 6 quadratischen Platten Elektro-Heißluftofen GN 1/1 cm. 68x36x34h Neutrales Schrankelement mit Tür Fourneau électrique - N. 6 plaques carrés Four à chaleur tournante électrique GN 1/1 cm. 68x36x34h Element neutre avec porte <p>Cocina eléctrica - N. 6 planchas cuadradas Horno eléctrico ventilado GN 1/1cm. 68x36x34h Armario neutro con puerta cm. 120x70,5x90h</p>		<p>20,92 kW 400V~3N 50/60 Hz</p>	<p>5.509,00 146 / 1,14</p>
CF6-712ET 08661232	<p>CUCINA 6 piastre Forno elettrico statico GN 3/1 cm. 108x55x34h</p> <ul style="list-style-type: none"> Electric Range - N. 6 plates Traditional electric oven GN 3/1 cm. 108x55x34h Elektroherd - N. 6 Kochplatten Statischer Elektro-Backofen GN 3/1 cm. 108x55x34h Fourneau électrique - N. 6 plaques Four électrique statique GN 3/1 cm. 108x55x34h <p>Cocina eléctrica - N. 6 planchas Horno eléctrico estático GN 3/1 cm. 108x55x34h cm. 120x70,5x90h</p>		<p>22,5 kW 400V~3N 50/60 Hz</p>	<p>4.381,00 136 / 1,14</p>
CFQ6-712ET 08661233	<p>CUCINA 6 piastre quadre Forno elettrico statico GN 3/1 cm. 108x55x34h</p> <ul style="list-style-type: none"> Electric Range - N. 6 square plates Traditional electric oven GN 3/1 cm. 108x55x34h Elektroherd - N. 6 quadratischen Platten Statischer Elektro-Backofen GN 3/1 cm. 108x55x34h Fourneau électrique - N. 6 plaques carrés Four électrique statique GN 3/1 cm. 108x55x34h <p>Cocina eléctrica - N. 6 planchas cuadradas Horno eléctrico estático GN 3/1 cm. 108x55x34h cm. 120x70,5x90h</p>		<p>22,5 kW 400V~3N 50/60 Hz</p>	<p>5.624,00 148 / 1,14</p>
CF6-712GPV 08681251	<p>CUCINA 6 fuochi Forno a gas statico GN 2/1 cm. 68x55x34h Vano neutro con porta</p> <ul style="list-style-type: none"> Gas Range - N. 6 burners Traditional gas-oven GN 2/1 cm. 68x55x34h Neutral cabinet with door Gasherd - N. 6 Kochstellen Statischer Gas-Backofen GN 2/1 cm. 68x55x34h - Neutrales Schrankelement mit Tür Cuisiniere Gaz - N. 6 feuxvifs Four à gaz statique GN 2/1 cm. 68x55x34h Elément neutre avec porte <p>Cocina a gas - N. 6 quemadores Horno a gas estático cm. 68x55x34h - Armario neutro con puerta cm. 120x70,5x90h</p>		<p>42,3 kW 36.378 kcal/h</p>	<p>4.599,00 178 / 1,14</p>
CF6-712GPEV 08691261	<p>CUCINA 6 fuochi - Forno elettrico statico GN 2/1 cm. 68x55x34h - Vano neutro con porta</p> <ul style="list-style-type: none"> Gas Range - N. 6 burners - traditional electric oven GN 2/1 cm. 68x55x34h Neutral cabinet with door Gasherd - N. 6 Kochstellen Statischer Elektro-Backofen GN 2/1 cm. 68x55x34h Neutrales Schrankelement mit Tür Cuisiniere gaz - N. 6 feuxvifs Four électrique statique GN 2/1 cm. 68x55x34h Element neutre avec porte <p>Cocina a gas - N. 6 quemadores Horno eléctrico estático GN 2/1 cm. 68x55x34h Armario neutro con puerta cm. 120x70,5x90h</p>		<p>35 kW 30.100 kcal/h</p>	<p>4.599,00 177 / 1,14</p> <p>5 kW 400V~3N 50/60 Hz</p>
CFV6-712GPEV 08691266	<p>CUCINA 6 fuochi - Forno elettrico ventilato GN 1/1 cm. 68x36x34h - Vano neutro con porta</p> <ul style="list-style-type: none"> Gas Range - N. 6 burners - electric fan oven GN 1/1 cm. 68x36x34h Neutral cabinet with door Gasherd - N. 6 Kochstellen Elektro-Heißluftofen GN 1/1 cm. 68x36x34h Neutrales Schrankelement mit Tür Cuisiniere gaz - N. 6 feuxvifs Four à chaleur tournante électrique GN 1/1 cm. 68x36x34h Element neutre avec porte <p>Cocina a gas - N. 6 quemadores Horno eléctrico ventilado GN 1/1 cm. 68x36x34h Armario neutro con puerta cm. 120x70,5x90h</p>		<p>35 kW 30.100 kcal/h</p>	<p>4.907,00 177 / 1,14</p> <p>5,32 kW 400V~3N 230V~3 50/60 Hz</p>

SUPERLOTUS 70

MOD. COD.	DESCRIZIONE / DESCRIPTION / BEZEICHNUNG / DESCRIPTION / DESCRIPCIÓN DIMENSIONI / DIMENSIONS / ABMESSUNGEN / DIMENSIONS / DIMENSIONES	POTENZA / POWER / LEISTUNG / PUISSANCE / POTENCIA VOLTAGGIO / VOLTAGE / SPANNUNG / VOLTAGE / VOLTAJE	$\frac{kW}{kcal/h}$ $\frac{V}{Hz}$	PREZZO / PRICE PREIS / PRIX / PRECIO € KG / M ³
CFA6-712GPV 08751251	<p>CUCINA ACQUA 6 fuochi - Forno a gas statico GN 2/1 cm. 68x55x34h - Vano neutro con porta Rubinetto carico acqua, sfioratore</p> <p>• Water range - N. 6 burners - Traditional gas-oven GN 2/1 cm. 68x55x34h - Neutral cabinet with door Water loading tap + overflow device</p> <p>• Wasser herd - N. 6 Kochstellen - Statischer Gas-Backofen GN 2/1 cm. 68x55x34h - Neutrales Schrankelement mit Tür Wasserlauf-Hahn + Überlauf-Vorrichtung</p> <p>• Cuisiniere l'eau - N. 6 feuxvifs Four à gaz statique GN 2/1 cm. 68x55x34h - Element neutre avec porte Robinet d'arrivée d'eau trop plein</p> <p>• Cocina a agua N. 6 quemadores Horno a gas estático cm. 68x55x34h - Armario neutro con puerta Grifo carga agua + vertedero cm. 120x70,5x90h</p>		$\frac{49,3}{42.398}$	5.636,00 178 / 1,14
				
CF6-712GP 08681250	<p>CUCINA 6 fuochi Forno a gas statico GN 3/1 cm. 108x55x34h</p> <p>• Gas Range - N. 6 burners Traditional gas-oven GN 3/1 cm. 108x55x34h</p> <p>• Gasherd - N. 6 Kochstellen Statischer Gas-Backofen GN 3/1 cm. 108x55x34h</p> <p>• Cuisiniere gaz - N. 6 feuxvifs Four à gaz statique GN 3/1 cm. 108x55x34h</p> <p>• Cocina a gas - N. 6 quemadores Horno a gas estático GN 3/1 cm. 108x55x34h cm. 120x70,5x90h</p>		$\frac{46}{39.560}$	5.144,00 197 / 1,14
				
CF6-712GPE 08691260	<p>CUCINA 6 fuochi Forno elettrico statico GN 3/1 cm. 108x55x34h</p> <p>• Gas Range - N. 6 burners Traditional electric oven GN 3/1 cm. 108x55x34h</p> <p>• Gasherd - N. 6 Kochstellen Statischer Elektro-Backofen GN 3/1 cm. 108x55x34h</p> <p>• Cuisiniere gaz - N. 6 feuxvifs Four électrique statique GN 3/1 cm. 108x55x34h</p> <p>• Cocina a gas - N. 6 quemadores Horno eléctrico estático GN 3/1 cm. 108x55x34h cm. 120x70,5x90h</p>		$\frac{35}{30.100}$	5.144,00 190 / 1,10
			$\frac{6,9}{400V-3N}$ 50/60 Hz	
PC-74ET 08030430	<p>PIANO COTTURA TRIFASE SU MOBILE A GIORNO - N. 2 piastre</p> <p>• Boiling unit threephase on open cabinet - N. 2 plates</p> <p>• Kochplatte dreiphasig mit offenem Unterbau N. 2 Kochplatten</p> <p>• Rechaud électriques sur armoire ouvert - N. 2 plaques</p> <p>• Sobre de cocción trifásico sobre mueble abierto N. 2 planchas cm. 40x70,5x90h</p>		$\frac{5,2}{400V-2N}$ 230V~3 230V~ 50/60 Hz	995,00 42 / 0,4
				
PC-78ET 08030830	<p>PIANO COTTURA TRIFASE SU MOBILE A GIORNO N. 4 piastre</p> <p>• Threephase boiling unit on open cabinet - N. 4 plates</p> <p>• Kochplatte dreiphasig mit offenem Unterbau N. 4 Kochplatten</p> <p>• Rechaud triphase sur armoire ouvert - N. 4 plaques</p> <p>• Sobre de cocción trifásico sobre mueble abierto N. 4 planchas cm. 80x70,5x90h</p>		$\frac{10,4}{400V-3N}$ 230V~3 50/60 Hz	1.531,00 68 / 0,77
				
PC-712ET 08031230	<p>PIANO COTTURA TRIFASE SU MOBILE A GIORNO N. 6 piastre</p> <p>• Threephase boiling unit on open cabinet - N. 6 plates</p> <p>• Kochplatte dreiphasig mit offenem Unterbau N. 6 Kochplatten</p> <p>• Rechaud triphase sur armoire ouvert - N. 6 plaques</p> <p>• Sobre de cocción trifásico sobre mueble abierto N. 6 planchas cm. 120x70,5x90h</p>		$\frac{15,6}{400V-3N}$ 230V~3 50/60 Hz	2.128,00 88 / 1,14
				

SUPERLOTUS 70

MOD. _____ DESCRIZIONE/DESCRIPTION/BEZEICHNUNG/DESCRIPTION/DESCRIPCIÓN POTENZA/POWER/LEISTUNG/PUISSANCE/POTENCIA PREZZO/PRICE €
 COD. _____ DIMENSIONI/DIMENSIONS/ABMESSUNGEN/DIMENSIONS/DIMENSIONES VOLTAGGIO/VOLTAGE/SPANNUNG/VOLTAGE/VOLTAJE kcal/h $\frac{kW}{V}$ PREIS/PRIX/PRECO €
 KG / M³

PCQ-74ET PIANO COTTURA TRIFASE SU MOBILE
 08030431 A GIORNO - N. 2 piastre quadre
 • Boiling unit threephase on open cabinet -
 N. 2 square plates
 • Kochplatte dreiphasig mit offenem Unterbau
 N. 2 quadratischen Platten
 • Rechaud électriques sur armoire ouvert -
 N. 2 plaques carrés
 • **Sobre de cocción trifásico sobre mueble abierto**
N. 2 planchas cuadradas
cm. 40x70,5x90h



$\frac{5,2}{400V \sim 2N}$ kW
 230V~3
 230V~
 50/60 Hz

1.487,00
 46 / 0,4



PCQ-78ET PIANO COTTURA TRIFASE SU MOBILE
 08030831 A GIORNO - N. 4 piastre quadre
 • Boiling unit threephase on open cabinet -
 N. 4 square plates
 • Kochplatte dreiphasig mit offenem Unterbau
 N. 4 quadratischen Platten
 • Rechaud électriques sur armoire ouvert -
 N. 4 plaques carrés
 • **Sobre de cocción trifásico sobre mueble abierto**
N. 4 planchas cuadradas
cm. 80x70,5x90h



$\frac{10,4}{400V \sim 3N}$ kW
 230V~3
 50/60 Hz

2.582,00
 71 / 0,77



PCQ-712ET PIANO COTTURA TRIFASE SU MOBILE
 08031231 A GIORNO - N. 6 piastre quadre
 • Boiling unit threephase on open cabinet -
 N. 6 square plates
 • Kochplatte dreiphasig mit offenem Unterbau
 N. 6 quadratischen Platten
 • Rechaud électriques sur armoire ouvert -
 N. 6 plaques carrés
 • **Sobre de cocción trifásico sobre mueble abierto**
N. 6 planchas cuadradas
cm. 120x70,5x90h

$\frac{15,6}{400V \sim 3N}$ kW
 230V~3
 50/60 Hz

3.681,00
 103 / 1,14



PCC-74ET PIANO COTTURA VETROCERAMICA TRIFASE
 08030432 su mobile a giorno - N. 2 zone - vetro cm.35x57
 • Ceramic glass boiling unit on open cabinet -
 n. 2 zones - glass cm.35x57
 • Ceran-Kochplatte dreiphasig mit offenem Unterbau -
 2 zonen - Glas 35x57 cm
 • Plan de cuisson à vitroceramique triphasé sur
 armoire ouvert N. 2 zones - Verre cm.35x57
 • **Sobre de cocción trifásico vitrocerámica sobre**
mueble abierto - 2 zonas - vidrio cm.35x57
cm. 40x70,5x90h

$\frac{5}{400V \sim 2N}$ kW
 230V~3
 230V~
 50/60 Hz

1.818,00
 41 / 0,4

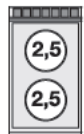

PCC-78ET PIANO COTTURA VETROCERAMICA TRIFASE
 08030832 su mobile a giorno - N. 4 zone - vetro cm. 75x57
 • Ceramic glass boiling unit on open cabinet -
 n. 4 zones - glass cm. 75 x57
 • Ceran-Kochplatte dreiphasig mit offenem Unterbau -
 4 zonen - Glas 75x57 cm
 • Plan de cuisson à vitroceramique triphasé sur
 armoire ouvert N. 4 zones - Verre cm 75x57
 • **Sobre de cocción trifásico vitrocerámica sobre**
mueble abierto - 4 zonas - vidrio cm. 75 x57
cm. 80x70,5x90h



$\frac{10}{400V \sim 3N}$ kW
 230V~3
 50/60 Hz



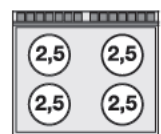

2.673,00
 66 / 0,77

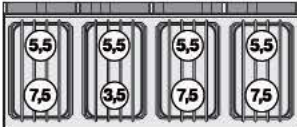

SUPERLOTUS 70

MOD. COD.	DESCRIZIONE/DESCRIPTION/BEZEICHNUNG/DESCRIPTION/DESCRIPCIÓN DIMENSIONI/DIMENSIONS/ABMESSUNGEN/DIMENSIONS/DIMENSIONES	POTENZA/POWER/LEISTUNG/PUISSANCE/POTENCIA VOLTAGGIO/VOLTAGE/SPANNUNG/VOLTAGE/VOLTAJE	kw kcal/h	kw V~ Hz	PREZZO/PRICE PREIS/PRIX/PRECIO €/KG / M ³
PCI-74ET 08030433	PIANO COTTURA INDUZIONE TRIFASE - N. 2 zone - Vetro cm.35x57 • Three-phase induction cooking - 2 zones - glass cm.35x57 • Induktions-Kochplatte dreiphasig - 2 zonen - Glas 35x57 cm • Plan de cuisson à induction triphasé N. 2 zones - Verre cm.35x57 • Encimera inducción trifásica - 2 zonas - Vidrio cm.35x57 cm. 40x70,5x90h		10 kW 400V~3 50/60 Hz		6.917,00 40 / 0,4
PCI-74ETD 08030438	Comandi digitali • Digital controls / • Digitale Steuerungen • Commandes numériques / • Controles digitales cm. 40x70,5x90h				7.408,00 40 / 0,4
PCIW-74ET 08030434	PIANO COTTURA INDUZIONE TRIFASE "WOK" - N. 1 zona - Vetro Ø 30 cm. • Three-phase induction cooking "WOK" - 1 zone - glass Ø 30 cm • Induktions-Kochplatte "WOK" dreiphasig - 1 zonen - Glas Ø 30 cm • Plan de cuisson à induction "WOK" triphasé N. 1 zone - Verre cm Ø 30 • Encimera inducción "WOK" trifásica - 1 zona - Vidrio Ø 30 cm. 40x70,5x90h		5 kW 400V~3 50/60 Hz		5.277,00 38 / 0,4
PCIW-74ETD 08030439	Comandi digitali • Digital controls / • Digitale Steuerungen • Commandes numériques / • Controles digitales cm. 40x70,5x90h				5.522,00 38 / 0,4
PCI-78ET 08030833	PIANO COTTURA INDUZIONE TRIFASE - N. 4 zone - Vetro cm.75x57 • Three-phase induction cooking - 4 zones - glass cm.75x57 • Induktions-Kochplatte dreiphasig - 4 zonen - Glas 75x57 cm • Plan de cuisson à induction triphasé N. 4 zones - Verre cm.75x57 • Encimera inducción trifásica - 4 zonas - Vidrio cm.75x57 cm. 80x70,5x90h		20 kW 400V~3 50/60 Hz		13.147,00 70 / 0,77
PCI-78ETD 08030838	Comandi digitali • Digital controls / • Digitale Steuerungen • Commandes numériques / • Controles digitales cm. 80x70,5x90h				14.127,00 70 / 0,77
PC-74GP 08210450	PIANO COTTURA GAS SU MOBILE A GIORNO 2 fuochi • Gas heated boiling unit on open cabinet - 2 burners • Gas-kochplatte mit offenem Unterbau - 2 Kochstellen • Rechaud gaz sur armoire ouvert - 2 feuxvifs • Sobres de cocción gas sobre mueble abierto - 2 quemadores cm. 40x70,5x90h		13 kW 11.180 kcal/h		1.424,00 63 / 0,4
PC-78GP 08210850	PIANO COTTURA GAS SU MOBILE A GIORNO 4 fuochi • Gas heated boiling unit on open cabinet - 4 burners • Gas-Kochplatte mit offenem Unterbau - 4 Kochstellen • Rechaud gaz sur armoire ouvert - 4 feuxvifs • Sobres de cocción gas sobre mueble abierto - 4 quemadores cm. 80x70,5x90h		22 kW 18.920 kcal/h		2.279,00 76 / 0,77

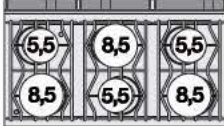
SUPERLOTUS 70

MOD. / COD.	DESCRIZIONE / DESCRIPTION / BEZEICHNUNG / DESCRIPTION / DESCRIPCIÓN DIMENSIONI / DIMENSIONS / ABMESSUNGEN / DIMENSIONS / DIMENSIONES	POTENZA / POWER / LEISTUNG / PUISSANCE / POTENCIA VOLTAGGIO / VOLTAGE / SPANNUNG / VOLTAGE / VOLTAJE	6 kW kcal/h	7 kW V~ Hz	PREZZO / PRICE € PREIS / PRIZ / PRECIO € KG / M³
PC-712GP 08211250	PIANO COTTURA GAS SU MOBILE A GIORNO 6 fuochi • Gas heated boiling unit on open cabinet - 6 burners • Gas-Kochplatte mit offenem Unterbau - 6 Kochstellen • Rechaud gaz sur armoire ouvert - 6 feuxvifs • Sobres de cocción gas sobre mueble abierto - 6 quemadores cm. 120x70,5x90h		35 kW 30.100 kcal/h		3.262,00 126 / 1,14
PC-716GP 08211650	PIANO COTTURA GAS SU MOBILE A GIORNO 8 fuochi • Gas heated boiling unit on open cabinet - 8 burners • Gas-Kochplatte mit offenem Unterbau - 8 Kochstellen • Rechaud gaz sur armoire ouvert - 8 feuxvifs • Sobres de cocción gas sobre mueble abierto - 8 quemadores cm. 160x70,5x90h		44 kW 37.840 kcal/h		4.520,00 152 / 1,54
PCA-74GP 08310450	PIANO COTTURA ACQUA SU MOBILE A GIORNO 2 fuochi - Rubinetto carico acqua, sfioratore • Water heated boiling unit on open cabinet - 2 burners - Water loading tap + overflow device • Wasser-Kochplatte mit offenem Unterbau - 2 Kochstellen - Wasserlauf-Hahn + Überlauf-Vorrichtung • Rechaud l'eau sur armoire ouvert - 2 feuxvifs - Robinet d'arrivée d'eau trop plein • Sobres de cocción agua sobre mueble abierto 2 quemadores - Grifo carga agua + vertedero cm. 40x70,5x90h		14 kW 12.040 kcal/h		1.593,00 63 / 0,4
PCA-78GP 08310850	PIANO COTTURA ACQUA SU MOBILE A GIORNO 4 fuochi - Rubinetto carico acqua, sfioratore • Water heated boiling unit on open cabinet - 4 burners - Water loading tap + overflow device • Wasser-kochplatte mit offenem Unterbau - 4 Kochstellen - Wasserlauf-Hahn + Überlauf-Vorrichtung • Rechaud l'eau sur armoire ouvert - 4 feuxvifs - Robinet d'arrivée d'eau trop plein • Sobres de cocción agua sobre mueble abierto 4 quemadores Grifo carga agua + vertedero cm. 80x70,5x90h		28 kW 24.080 kcal/h		3.134,00 76 / 0,77
PCA-712GP 08311250	PIANO COTTURA ACQUA SU MOBILE A GIORNO 6 fuochi - Rubinetto carico acqua, sfioratore • Water heated boiling unit on open cabinet - 6 burners - Water loading tap + overflow device • Wasser-kochplatte mit offenem Unterbau - 6 Kochstellen - Wasserlauf-Hahn + Überlauf-Vorrichtung • Rechaud l'eau sur armoire ouvert - 6 feuxvifs - Robinet d'arrivée d'eau trop plein • Sobres de cocción agua sobre mueble abierto 6 quemadores Grifo carga agua + vertedero cm. 120x70,5x90h		42 kW 36.120 kcal/h		4.503,00 126 / 1,14
PCW-74G 08210454	PIANO COTTURA GAS "WOK"- SU MOBILE A GIORNO - 1 fuoco - fiamma verticale - ANELLO WOK • Gas heated boiling "WOK" on open cabinet - 1 burner - vertical flame - Wok ring • Gas-Kochplatte "WOK" mit offenem Unterbau - 1 Kochstellen - vertikaler Flamme - Wok Aufsatzring • Rechaud gaz "WOK" sur armoire ouvert - 1 feuxvifs - verticale de la flamme - Anneau Wok • Sobres de cocción gas "WOK" sobre mueble abierto - 1 quemador - llama vertical - Anillo Wok cm. 40x70,5x90h		10 kW 8.600 kcal/h		2.040,00 66 / 0,4



SUPERLOTUS 70

MOD. COD.	DESCRIZIONE/DESCRIPTION/BEZEICHNUNG/DESCRIPTION/DESCRIPCIÓN DIMENSIONI/DIMENSIONS/ABMESSUNGEN/DIMENSIONS/DIMENSIONES	POTENZA/POWER/LEISTUNG/PUISSANCE/POTENCIA VOLTAGGIO/VOLTAGE/SPANNUNG/VOLTAGE/VOLTAJE	$\frac{kW}{kcal/h}$ $\frac{V}{Hz}$	PREZZO/PRICE PREIS/PRIX/PRECIO € KG / M ³
PA-78G 08210851	"PAELLERO" GAS SU MOBILE A GIORNO <ul style="list-style-type: none"> "PAELLERO" Gas - open cabinet "PAELLERO" Gas mit offenem Unterbau "PAELLERO" gaz sur armoire ouvert "PAELLERO" gas sobre mueble abierto cm. 80x70,5x90h		11,5 kW 9.890 kcal/h	2.588,00 111 / 0,77
PAF-78G 08680851	"PAELLERO" GAS SU FORNO GAS statico GN 2/1 cm. 68x55x34h <ul style="list-style-type: none"> "PAELLERO" Gas on Traditional gas-oven "PAELLERO" Gas mit Statischer Gas-Backofen "PAELLERO" gaz sur Four à gaz statique "PAELLERO" gas sobre Horno a gas estático GN 2/1 cm. 68x55x34h cm. 80x70,5x90h		18,8 kW 16.168 kcal/h	3.224,00 159 / 0,77
TP-74G 08290450	TUTTA PIASTRA SU MOBILE A GIORNO Piastra cm 37x57 <ul style="list-style-type: none"> Solid top on open unit - Plate 37x57cm Kochplatte auf offenem Unterbau - Platte 37x57 cm Toute plaque sur meuble ouvert - Plaque cm 37x57 Placa de cocción sobre mueble abierto - Placa cm 37x57 cm. 40x70,5x90h		7 kW 6.020 kcal/h	1.734,00 65 / 0,40
TP-78G 08290850	TUTTA PIASTRA SU MOBILE A GIORNO Piastra cm 77x57 <ul style="list-style-type: none"> Solid top on open unit - Plate 77x57cm Kochplatte auf offenem Unterbau - Platte 77x57 cm Toute plaque sur meuble ouvert - Plaque cm 77x57 Placa de cocción sobre mueble abierto - Placa cm 77x57 cm. 80x70,5x90h		12 kW 10.320 kcal/h	2.357,00 121 / 0,77
TP2-78GP 08300850	TUTTA PIASTRA + 2 FUOCHI SU MOBILE A GIORNO Piastra cm. 37x57 <ul style="list-style-type: none"> Solid top + 2 burners on open unit Plate 37x57 Kochplatte + 2 Gaskochstellen auf offenem Unterbau Platte 37x57 Toute plaque + 2 brûleurs sur meuble ouvert Plaque cm. 37x57 Placa de cocción + 2 fuegos sobre mueble abierto Placa cm. 37x57 cm. 80x70,5x90h		20 kW 17.200 kcal/h	2.401,00 115 / 0,77
TP2-71 2GP 08291250	TUTTA PIASTRA + 2 FUOCHI SU MOBILE A GIORNO Piastra cm. 77x57 <ul style="list-style-type: none"> Solid top + 2 burners on open unit Plate 77x57 Kochplatte + 2 Gaskochstellen auf offenem Unterbau Platte 77x57 Toute plaque + 2 brûleurs sur meuble ouvert Plaque cm. 77x57 Placa de cocción + 2 fuegos sobre mueble abierto Placa cm. 77x57 cm. 120x70,5x90h		25 kW 21.500 kcal/h	3.508,00 157 / 1,14
TP4-71 2GP 08301250	TUTTA PIASTRA + 4 FUOCHI SU MOBILE A GIORNO Piastra cm. 37x57 <ul style="list-style-type: none"> Solid top + 4 burners on open unit Plate 37x57 cm Kochplatte + 4 Gaskochstellen auf offenem Unterbau Platte 37x57 cm Toute plaque + 4 brûleurs sur meuble ouvert Plaque cm. 37x57 Placa de cocción + 4 fuegos sobre mueble abierto Placa cm. 37x57 cm. 120x70,5x90h		29 kW 24.940 kcal/h	3.609,00 154 / 1,14

SUPERLOTUS 70

MOD. / COD.	DESCRIZIONE / DESCRIPTION / BEZEICHNUNG / DESCRIPTION / DESCRIPCIÓN DIMENSIONI / DIMENSIONS / ABMESSUNGEN / DIMENSIONS / DIMENSIONES	POTENZA / POWER / LEISTUNG / PUISSANCE / POTENCIA VOLIAGGIO / VOLTAGE / SPANNUNG / VOLTAGE / VOLTAJE	⚡ kW kcal/h	⚡ kw V~ Hz	PREZZO / PRICE PREIS / PRIX / PRECIO € KG / M ³
TP-78ET 08120830	TUTTA PIASTRA SU MOBILE A GIORNO Piastra cm. 70x50 - 4 zone • Solid top on open unit - Plate cm. 70x50 - 4 zones • Kochplatten auf offenem Unterbau - Platte cm. 70x50 - 4 zonen • Toute plaque sur meuble ouvert - Plaque cm. 70x50 - 4 zones • Placa de cocción sobre mueble abierto - Placa cm. 70x50 - 4 zonas cm. 80x70,5x90h		⚡ 10 kW 400V~3N 50/60 Hz		2.904,00 121 / 0,77
TPF-78ET 08670830	Tutta piastra su Forno elettrico statico GN 2/1 cm. 68x55x34h - piastra cm. 70x50 4 zone • Solid top on traditional electric oven GN 2/1 cm. 68x55x34h - Plate cm. 70x50 4 zones • Kochplatten - Statischer Elektro-Backofen GN 2/1 cm. 68x55x34h - Platte cm. 70x50 4 zonen • Toute plaque sur Four électrique statique GN 2/1 cm. 68x55x34h - Plaque cm. 70x50 4 zones • Placa de cocción sobre Horno eléctrico estático GN 2/1 cm. 68x55x34h - Placa cm. 70x50 4 zonas cm. 80x70,5x90h		⚡ 15 kW 400V~3N 50/60 Hz		4.081,00 170 / 0,77
TPFV-78ET 08670835	Tutta piastra su Forno elettrico ventilato GN 1/1 cm. 68x36x34h - piastra cm. 70x50 4 zone • Solid top on electric fan oven GN 1/1 cm. 68x36x34h - Plate cm. 70x50 4 zones • Kochplatten - Elektro-Heißluftofen GN 1/1 cm. 68x36x34h - Platte cm. 70x50 4 Zonen • Toute plaque sur Four à chaleur tournante électrique GN 1/1 cm. 68x36x34h - Plaque cm. 70x50 4 zones • Placa de cocción sobre Horno eléctrico ventilado GN 1/1 cm. 68x36x34h - Placa cm. 70x50 4 zonas cm. 80x70,5x90h		⚡ 15,32 kW 400V~3N 50/60 Hz		4.397,00 170 / 0,77
TPF-78G 08700850	TUTTA PIASTRA SU FORNO GAS statico GN 2/1 cm. 68x55x34h Piastra cm. 77x57 • Solid top on Traditional gas-oven GN 2/1 cm. 68x55x34h - Plate cm. 77x57 • Kochplatten - Statischer Gas-Backofen GN 2/1 cm. 68x55x34h - Platte cm. 77x57 • Toute plaque sur Four à gaz statique GN 2/1 cm. 68x55x34h - Plaque cm. 77x57 • Placa de cocción sobre Horno a gas estático GN 2/1 cm. 68x55x34h - Placa cm. 77x57 cm. 80x70,5x90h		⚡ 19,3 kW 16.600 kcal/h		3.636,00 169 / 0,77
TPF-78GE 08710860	Tutta piastra su Forno elettrico statico GN 2/1 cm. 68x55x34h - piastra cm. 77x57 • Solid top on traditional electric oven GN 2/1 cm. 68x55x34h - Plate cm. 77x57 • Kochplatten - Statischer Elektro-Backofen GN 2/1 cm. 68x55x34h - Platte cm. 77x57 • Toute plaque sur Four électrique statique GN 2/1 cm. 68x55x34h - Plaque cm. 77x57 • Placa de cocción sobre Horno eléctrico estático GN 2/1 cm. 68x55x34h - Placa cm. 77x57 cm. 80x70,5x90h		⚡ 12 kW 10.320 kcal/h		3.636,00 170 / 1,77
TPFV-78GE 08710865	Tutta piastra su Forno elettrico ventilato GN 1/1 cm. 68x36x34h - piastra cm. 77x57 • Solid top on electric fan oven GN 1/1 cm. 68x36x34h - Plate cm. 77x57 • Kochplatten - Elektro-Heißluftofen GN 1/1 cm. 68x36x34h - Platte cm. 77x57 • Toute plaque sur Four à chaleur tournante électrique GN 1/1 cm. 68x36x34h - Plaque cm. 77x57 • Placa de cocción sobre Horno eléctrico ventilado GN 1/1 cm. 68x36x34h - Placa cm. 77x57 cm. 80x70,5x90h		⚡ 12 kW 10.320 kcal/h		3.967,00 170 / 1,77

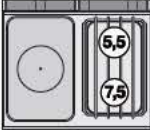
SUPERLOTUS 70

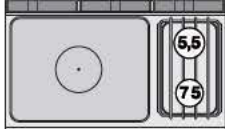
MOD. COD.	DESCRIZIONE/DESCRIPTION/BEZEICHNUNG/DESCRIPTION/DESCRIPCIÓN DIMENSIONI/DIMENSIONS/ABMESSUNGEN/DIMENSIONS/DIMENSIONES	POTENZA/POWER/LEISTUNG/PUISSANCE/POTENCIA VOLTAGGIO/VOLTAGE/SPANNUNG/VOLTAGE/VOLTAGE	€ kW kcal/h	€ kw V~ Hz	PREZZO/PRICE € PREIS/PRIX/PRECIO € KG / M ³
TPF2-78GP 08720850	TUTTA PIASTRA + 2 FUOCHI SU FORNO GAS statico GN 2/1 cm. 68x55x34h - Piastra cm 37x57 <ul style="list-style-type: none"> Solid top + 2 burners Traditional gas-oven GN 2/1 cm. 68x55x34h - Plate 37x57cm Kochplatte + 2 Gaskochstellen auf Statischer Gas-Backofen GN 2/1 cm. 68x55x34h Platte 37x57 cm Toute plaque + 2 brûleurs sur Four à gaz statique GN 2/1 cm. 68x55x34h Plaque cm. 37x57 Placa de cocción + 2 fuegos sobre Horno a gas estático GN 2/1 cm. 68x55x34h Placa cm 37x57 cm. 80x70,5x90h 		€ 27,3 kW 23.478 kcal/h	€ 3.905,00 165 / 0,77	
TPF2-78GPE 08730860	TUTTA PIASTRA + 2 FUOCHI SU Forno elettrico statico GN 2/1 cm. 68x55x34h - Piastra cm 37x57 <ul style="list-style-type: none"> Solid top + 2 burners traditional electric oven GN 2/1 cm. 68x55x34h - Plate 37x57cm Kochplatte + 2 Gaskochstellen auf Statischer Elektro-Backofen GN 2/1 cm. 68x55x34h Platte 37x57 cm Toute plaque + 2 brûleurs sur Four électrique statique GN 2/1 cm. 68x55x34h Plaque cm. 37x57 Placa de cocción + 2 fuegos sobre Horno eléctrico estático GN 2/1 cm. 68x55x34h Placa cm 37x57 cm. 80x70,5x90h 		€ 20 kW 17.200 kcal/h	€ 3.905,00 166 / 1,77	
TPFV2-78GPE 08730865	TUTTA PIASTRA + 2 FUOCHI SU Forno elettrico ventilato GN 1/1 cm. 68x36x34h - Piastra cm 37x57 <ul style="list-style-type: none"> Solid top + 2 burners electric fan oven GN 1/1 cm. 68x36x34h - Plate 37x57cm Kochplatte + 2 Gaskochstellen auf Elektro-Heißluftofen GN 1/1 cm. 68x36x34h Platte 37x57 cm Toute plaque + 2 brûleurs sur Four à chaleur tournante électrique GN 1/1 cm. 68x36x34h Plaque cm. 37x57 Placa de cocción + 2 fuegos sobre Horno eléctrico ventilado GN 1/1 cm. 68x36x34h Placa cm 37x57 cm. 80x70,5x90h 		€ 20 kW 17.200 kcal/h	€ 4.227,00 166 / 1,77	
TPFV2-712GPV 08701251	TUTTA PIASTRA + 2 FUOCHI SU FORNO GAS statico GN 2/1 cm. 68x55x34h - Piastra cm 77x57 - vano neutro con porta <ul style="list-style-type: none"> Solid top + 2 burners Traditional gas-oven GN 2/1 cm. 68x55x34h - Plate 77x57cm - Neutral cabinet with door Kochplatte + 2 Gaskochstellen auf Statischer Gas-Backofen GN 2/1 cm. 68x55x34h Platte 77x57 cm - Neutrales Schrankelement mit Tür Toute plaque + 2 brûleurs sur Four à gaz statique GN 2/1 cm. 68x55x34h Plaque cm. 77x57 - Element neutre avec porte Placa de cocción + 2 fuegos sobre Horno a gas estático GN 2/1 cm. 68x55x34h Placa cm 77x57 - Armario neutro con puerta cm. 120x70,5x90h 		€ 32,3 kW 27.778 kcal/h	€ 5.006,00 227 / 1,14	
TPF2-712GPEV 08711261	TUTTA PIASTRA + 2 FUOCHI SU Forno elettrico statico GN 2/1 cm. 68x55x34h - Piastra cm 77x57 - vano neutro con porta <ul style="list-style-type: none"> Solid top + 2 burners traditional electric oven GN 2/1 cm. 68x55x34h - Plate 77x57cm - Neutral cabinet with door Kochplatte + 2 Gaskochstellen auf Statischer Elektro-Backofen GN 2/1 cm. 68x55x34h Platte 77x57 cm - Neutrales Schrankelement mit Tür Toute plaque + 2 brûleurs sur Four électrique statique GN 2/1 cm. 68x55x34h Plaque cm. 77x57 - Element neutre avec porte Placa de cocción + 2 fuegos sobre Horno eléctrico estático GN 2/1 cm. 68x55x34h Placa cm 77x57 - Armario neutro con puerta cm. 120x70,5x90h 		€ 25 kW 21.500 kcal/h	€ 5.006,00 227 / 1,14	
TPFV2-712GPEV 08711266	TUTTA PIASTRA + 2 FUOCHI SU Forno elettrico ventilato GN 1/1 cm. 68x36x34h - Piastra cm 77x57 - vano neutro con porta <ul style="list-style-type: none"> Solid top + 2 burners electric fan oven GN 1/1 cm. 68x36x34h - Plate 77x57cm - Neutral cabinet with door Kochplatte + 2 Gaskochstellen auf Elektro-Heißluftofen GN 1/1 cm. 68x36x34h Platte 77x57 cm - Neutrales Schrankelement mit Tür Toute plaque + 2 brûleurs sur Four à chaleur tournante électrique GN 1/1 cm. 68x36x34h Plaque cm. 77x57 - Element neutre avec porte Placa de cocción + 2 fuegos sobre Horno eléctrico ventilado GN 1/1 cm. 68x36x34h Placa cm 77x57 - Armario neutro con puerta cm. 120x70,5x90h 		€ 25 kW 21.500 kcal/h	€ 5.336,00 227 / 1,14	

SUPERLOTUS 70

MOD. / COD. DESCRIZIONE / DESCRIPTION / BEZEICHNUNG / DESCRIPTION / DESCRIPCIÓN DIMENSIONI / DIMENSIONS / ABMESSUNGEN / DIMENSIONS / DIMENSIONES POTENZA / POWER / LEISTUNG / PUISSANCE / POTENCIA VOLTAGGIO / VOLTAGE / SPANNUNG / VOLTAGE / VOLTAJE $\frac{kW}{kcal/h}$ $\frac{kW}{V \sim}$ Hz PREZZO / PRICE € KG / M³

TPF2-712GP
08701250 TUTTA PIASTRA + 2 FUOCHI SU FORNO GAS statico GN 3/1 cm. 108x55x34h - Piastra cm 77x57
 • Solid top + 2 burners Traditional gas-oven GN 3/1 cm. 108x55x34h - Plate 77x57
 • Kochplatte + 2 Gaskochstellen auf Statischer Gas-Backofen GN 3/1 cm. 108x55x34h Platte 77x57
 • Toute plaque + 2 brûleurs sur Four à gaz statique GN 3/1 cm. 108x55x34h Plaque cm. 77x57
• Placa de cocción + 2 fuegos sobre Horno a gas estático GN 3/1 cm. 108x55x34h Placa cm 77x57 cm. 120x70,5x90h



$\frac{36 kW}{30.960 kcal/h}$ **5.368,00**
209 / 1,14

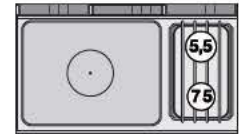

TPF2-712GPE
08711260 TUTTA PIASTRA + 2 FUOCHI SU Forno elettrico statico GN 3/1 cm. 108x55x34h - Piastra cm 77x57
 • Solid top + 2 burners traditional electric oven GN 3/1 cm. 108x55x34h - Plate 77x57
 • Kochplatte + 2 Gaskochstellen auf Statischer Elektro-Backofen GN 3/1 cm. 108x55x34h Platte 77x57
 • Toute plaque + 2 brûleurs sur Four électrique statique GN 3/1 cm. 108x55x34h Plaque cm. 77x57
• Placa de cocción + 2 fuegos sobre Horno eléctrico estático GN 3/1 cm. 108x55x34h Placa cm 77x57 cm. 120x70,5x90h

$\frac{25 kW}{21.500 kcal/h}$ **5.368,00**
209 / 1,14

$\frac{6,9 kW}{400V \sim 3N}$
50/60 Hz

TPF4-712GPV
08721251 TUTTA PIASTRA + 4 FUOCHI SU FORNO GAS statico GN 2/1 cm. 68x55x34h - Piastra cm 37x57 - vano neutro con porta
 • Solid top + 4 burners Traditional gas-oven GN 2/1 cm. 68x55x34h - Plate 37x57cm - Neutral cabinet with door
 • Kochplatte + 4 Gaskochstellen auf Statischer Gas-Backofen GN 2/1 cm. 68x55x34h Platte 37x57 cm - Neutrales Schrankelement mit Tür
 • Toute plaque + 4 brûleurs sur Four à gaz statique GN 2/1 cm. 68x55x34h Plaque cm. 37x57 - Element neutre avec porte
• Placa de cocción + 4 fuegos sobre Horno a gas estático GN 2/1 cm. 68x55x34h Placa cm 37x57 - Armario neutro con puerta cm. 120x70,5x90h



$\frac{36,3 kW}{31.218 kcal/h}$ **5.004,00**
221 / 1,14

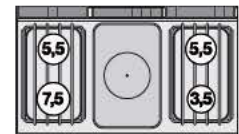

TPF4-712GPEV
08731261 TUTTA PIASTRA + 4 FUOCHI SU Forno elettrico statico GN 2/1 cm. 68x55x34h - Piastra cm 37x57 - vano neutro con porta
 • Solid top + 4 burners traditional electric oven GN 2/1 cm. 68x55x34h - Plate 37x57cm Neutral cabinet with door
 • Kochplatte + 4 Gaskochstellen auf Statischer Elektro-Backofen GN 2/1 cm. 68x55x34h Platte 37x57 cm - Neutrales Schrankelement mit Tür
 • Toute plaque + 4 brûleurs sur Four électrique statique GN 2/1 cm. 68x55x34h Plaque cm. 37x57 - Element neutre avec porte
• Placa de cocción + 4 fuegos sobre Horno eléctrico estático GN 2/1 cm. 68x55x34h Placa cm 37x57 - Armario neutro con puerta cm. 120x70,5x90h

$\frac{29 kW}{24.940 kcal/h}$ **5.004,00**
221 / 1,14

$\frac{5 kW}{400V \sim 3N}$
50/60 Hz

TPFV4-712GPEV
08731266 TUTTA PIASTRA + 4 FUOCHI SU Forno elettrico ventilato GN 1/1 cm. 68x36x34h - Piastra cm 37x57 - vano neutro con porta
 • Solid top + 4 burners electric fan oven GN 1/1 cm. 68x36x34h - Plate 37x57cm Neutral cabinet with door
 • Kochplatte + 4 Gaskochstellen auf Elektro-Heißluftofen GN 1/1 cm. 68x36x34h Platte 37x57 cm - Neutrales Schrankelement mit Tür
 • Toute plaque + 4 brûleurs sur Four à chaleur tournante électrique GN 1/1 cm. 68x36x34h Plaque cm. 37x57 - Element neutre avec porte
• Placa de cocción + 4 fuegos sobre Horno eléctrico ventilado GN 1/1 cm. 68x36x34h Placa cm 37x57 - Armario neutro con puerta cm. 120x70,5x90h

$\frac{29 kW}{24.940 kcal/h}$ **5.326,00**
221 / 1,14

$\frac{5,32 kW}{400V \sim 3N}$
230V ~ 3
50/60 Hz

SUPERLOTUS 70

MOD. COD.	DESCRIZIONE/DESCRIPTION/BEZEICHNUNG/DESCRIPTION/DESCRIPCIÓN DIMENSIONI/DIMENSIONS/ABMESSUNGEN/DIMENSIONS/DIMENSIONES	POTENZA/POWER/LEISTUNG/PUISSANCE/POTENCIA VOLTAGGIO/VOLTAGE/SPANNUNG/VOLTAGE/VOLTAJE	kw kcal/h	kw V~ Hz	PREZZO/PRICE PREIS/PRIX/PRECIO €/KG / M ³
TPF4-712GP 08721250	TUTTA PIASTRA + 4 FUOCHI SU FORNO GAS statico GN 3/1 cm. 108x55x34h - Piastra cm 37x57 <ul style="list-style-type: none"> Solid top + 4 burners traditional gas-oven GN 3/1 cm. 108x55x34h - Plate 37x57cm Kochplatte + 4 Gaskochstellen auf Statischer Gas-Backofen GN 3/1 cm. 108x55x34h Platte 37x57 cm Toute plaque + 4 brûleurs sur Four à gaz statique GN 3/1 cm. 108x55x34h Plaque cm. 37x57 Placa de cocción + 4 fuegos sobre Horno a gas estático GN 3/1 cm. 108x55x34h Placa cm 37x57 cm. 120x70,5x90h 		40 kW 34.400 kcal/h		5.613,00 202 / 1,14
					
TPF4-712GPE 08731260	TUTTA PIASTRA + 4 FUOCHI SU Forno elettrico statico GN 3/1 cm. 108x55x34h - Piastra cm 37x57 <ul style="list-style-type: none"> Solid top + 4 burners traditional electric oven GN 3/1 cm. 108x55x34h - Plate 37x57cm Kochplatte + 4 Gaskochstellen auf Statischer Elektro-Backofen GN 3/1 cm. 108x55x34h Platte 37x57 cm Toute plaque + 4 brûleurs sur Four électrique statique GN 3/1 cm. 108x55x34h Plaque cm. 37x57 Placa de cocción + 4 fuegos sobre Horno eléctrico estático GN 3/1 cm. 108x55x34h Placa cm 37x57 cm. 120x70,5x90h 		29 kW 24.940 kcal/h		5.613,00 202 / 1,14
				6,9 kW 400V~3N 50/60 Hz	
BM-74EM 08050410	BAGNOMARIA MONOFASE SU MOBILE A GIORNO Vasca per GN 1/1 h.15, rubinetto carico acqua, scarico a pavimento <ul style="list-style-type: none"> Bain marie singlephase on open cabinet - Bowl for GN 1/1 h.15, water loading cock, floor draining Wasserbäder einphasig mit offenem Unterbau - Becken GN 1/1 h.15, Wasserlauf-Hahn, Ablauf am Boden Bain marie monophase sur armoire ouvert - Cuve GN 1/1 h.15 - Robinet d'arrivée d'eau, système de vidange au sol Baño de maría monofásico sobre mueble abierto Cuba para GN 1/1 15h - Grifo carga agua, descarga a pavimento cm. 40x70,5x90h 		2,1 kW 230V~ 50/60 Hz		1.379,00 41 / 0,4
					
BM-74G 08220450	BAGNOMARIA GAS SU MOBILE A GIORNO Vasca per GN 1/1 h.15, rubinetto carico acqua, scarico a pavimento <ul style="list-style-type: none"> Gas bain marie on open cabinet - Bowl for GN 1/1 h.15, water loading cock, floor draining Gas Wasserbad mit offenem Unterbau - Becken GN 1/1 h.15, Wasserlauf-Hahn, Ablauf am Boden Bain-marie gaz sur armoire ouvert Cuve pour GN 1/1 h.15 - Robinet d'arrivée d'eau, système de vidange au sol Baño de maría gas sobre mueble abierto - Cuba para GN 1/1 15h, grifo carga agua, descarga a pavimento cm. 40x70,5x90h 		3,5 kW 3.010 kcal/h		1.526,00 49 / 0,4
					
BM-78ET 08050830	BAGNOMARIA TRIFASE SU MOBILE A GIORNO Vasca per GN 2/1 15h, rubinetto carico acqua, scarico a pavimento <ul style="list-style-type: none"> Bain marie threephase on open cabinet - Bowl for GN 2/1 15h, water loading cock, floor draining Wasserbäder Dreiphasig mit offenem Unterbau - Becken GN 2/1 15h, Wasserlauf-Hahn, Ablauf am Boden Bain marie triphase sur armoire ouvert Cuve GN 2/1 15h, Robinet d'arrivée d'eau, système de vidange au sol Baño de maría trifásico. sobre mueble abierto Cuba para GN 2/1 15h, grifo carga agua, descarga a pavimento cm. 80x70,5x90h 		4,2 KW 400V~2N 230V~3 50/60 Hz		1.950,00 61 / 0,77
					
BM-78G 08220850	BAGNOMARIA GAS SU MOBILE A GIORNO Vasca per GN 2/1 h.15, rubinetto carico acqua, scarico a pavimento. <ul style="list-style-type: none"> Gas ain marie on open cabinet. Bowl for GN 2/1 h.15, water loading cock, floor draining Gas Wasserbad mit offenem Unterbau. Becken GN 2/1 h.15, Wasserlauf-Hahn, Ablauf am Boden. Bain-marie gaz sur armoire ouvert. Cuve pour GN 2/1 h.15, robinet d'arrivée d'eau, système de vidange au sol Baño de maría gas sobre mueble abierto. Cuba para GN 2/1 15h, grifo carga agua, descarga a pavimento. cm. 80x70,5x90h 		6,5 kW 5.590 kcal/h		2.431,00 68 / 0,77
					

SUPERLOTUS 70

MOD. _____ DESCRIZIONE/DESCRIPTION/BEZEICHNUNG/DESCRIPTION/DESCRIPCIÓN POTENZA/POWER/LEISTUNG/PUISSANCE/POTENCIA 6kW kcal/h 1kw V~ PREZZO/PRICE € KG / M³
 COD. _____ DIMENSIONI/DIMENSIONS/ABMESSUNGEN/DIMENSIONS/DIMENSIONES VOLTAGGIO/VOLTAGE/SPANNUNG/VOLTAGE/VOLTAJE 230V~ PREIS/PRIZ/PRECO €

BS-74EM
08040410

CONTENITORE CALDO CON INFRAROSSO, MONOFASE SU MOBILE A GIORNO
 Vasca cm. 30,5x51x16,5h con falsofondo forato
 • Fry dump singlephase with infra-red heater on open cabinet. Bowl cm. 30,5x51x16,5h with perforated double bottom
 • Frittenwanne Einphasig mit Infrarot-strahler mit offenem Unterbau. Becke cm. 30,5x51x16,5h mit gelochtem Bodenrost
 • Silo a frites monophasé avec infrarouge sur armoire ouvert. Cuve cm 30,5x51x16,5h avec double-fond perforé.
 • Contenedor caliente por infrarrojo, monofásico y sobre mueble abierto. Cuba cm. 30,5x51x16,5h con falso fondo agujereado
cm. 40x70,5x90h



1,47 kW 1.738,00
 230V~ 42 / 0,4
 50/60 Hz

CP-74ET
08100430

CUOCIPASTA TRIFASE LT. 25 Vasca cm. 30,5x33,5x32,7h per GN 2/3, rubinetto c arico acqua, sfioratore + scarico a pavimento.
 • Pasta cooker threephase 25 lts. Tank cm. 30,5x33,5x32,7h for GN 2/3, water loading cock + overflow device and floor draining
 • Nudelkocher Dreiphasig lt. 25. Becken cm. 30,5x33,5x32,7h für GN 2/3, Wasserlauf-Hahn, + Überlauf-Vorrichtung und Ablauf am Boden
 • Cuiseur à pâtes triphase lt. 25. Cuve cm.30,5x33,5x32,7h pour GN 2/3, Robinet d'arrivée d'eau trop plein + système de vidange au sol
 • **Cucece pasta trifásico. Cuba cm. 30,5x33,5x32,7h para GN 2/3, grifo carga agua + vertedero + descarga a pavimento cm. 40x70,5x90h**



7,8 kW 2.522,00
 400V~3N 48 / 0,4
 50/60 Hz

CPA-74ET
08100435

Carico acqua automatico con sensore di livello
 • Automatic Water loading with level sensor
 • Automatische Wasser Beladung mit Niveauregulierung
 • Chargement automatique de l'eau avec sensor de niveau
 • **Carga automática de agua con sensor de nivel**

7,8 kW 2.914,00
 400V~3N 48 / 0,4
 50/60 Hz

COMBINAZIONI

- Combinations / • Zusammenstellungen
- Combinaisons / • Combinación múltiple



CP-76ET
08100630

CUOCIPASTA TRIFASE LT. 40 Vasca cm. 51x30,7x32,7h per GN 1/1, rubinetto carico acqua, sfioratore + scarico a pavimento.
 • Pasta cooker threephase 40 lts. Tank cm. 51x30,7x32,7h for GN 1/1, water loading cock + overflow device and floor draining
 • Nudelkocher Dreiphasig lt. 40. Becken cm. 51x30,7x32,7h für GN 1/1, Wasserlauf-Hahn, + Überlauf-Vorrichtung und Ablauf am Boden
 • Cuiseur à pâtes triphase lt. 40. Cuve cm.51x30,7x32,7h pour GN 1/1, Robinet d'arrivée d'eau trop plein + système de vidange au sol
 • **Cucece pasta trifásico 40 l. Cuba cm. 51x30,7x32,7h para GN 1/1, grifo carga agua + vertedero + descarga a pavimento cm. 60x70,5x90h**

13,5 kW 3.184,00
 400V~3N 78 / 0,5
 50/60 Hz

CPA-76ET
08100635

Carico acqua automatico con sensore di livello
 • Automatic Water loading with level sensor
 • Automatische Wasser Beladung mit Niveauregulierung
 • Chargement automatique de l'eau avec sensor de niveau
 • **Carga automática de agua con sensor de nivel**







13,5 kW 3.575,00
 400V~3N 78 / 0,5
 50/60 Hz

COMBINAZIONI

- Combinations / • Zusammenstellungen
- Combinaisons / • Combinación múltiple



SUPERLOTUS 70

MOD. COD.	DESCRIZIONE/DESCRIPTION/BEZEICHNUNG/DESCRIPTION/DESCRIPCIÓN DIMENSIONI/DIMENSIONS/ABMESSUNGEN/DIMENSIONS/DIMENSIONES	POTENZA/POWER/LEISTUNG/PUISSANCE/POTENCIA VOLTAGGIO/VOLTAGE/SPANNUNG/VOLTAGE/VOLTAGE	€ kW kcal/h	PREZZO/PRICE PREIS/PRIX/PRECIO € KG / M ³
CP-74G 08270450	CUOCIPASTA GAS LT 25 Vasca cm. 30,5x33,5x32,7h per GN 2/3. Rubinetto carico acqua, sfioratore + scarico a pavimento. • Gas pasta cooker 25 lts. Tank cm. 30,5x33,5x32,7h for GN 2/3, water loading cock + overflow device and floor draining • Gas-Nudelkocher lt. 25. Becken cm. 30,5x33,5x32,7h für GN 2/3, Wasserlauf-Hahn, + Überlauf-Vorrichtung und Ablauf am Boden • Cuiseur à pâtes gaz lt. 25. Cuve cm.30,5x33,5x32,7h pour GN 2/3, Robinet d'arrivée d'eau trop plein + système de vidange au sol • Cucee pasta gas 25 l. Cuba cm. 30,5x33,5x32,7h para GN 2/3, grifo carga agua + vertedero + descarga a pavimento cm. 40x70,5x90h		9,5 kW 8.160 kcal/h	3.000,00 61 / 0,4
CPA-74G 08270455	Carico acqua automatico con sensore di livello • Automatic Water loading with level sensor • Automatische Wasser Beladung mit Niveauregulierung • Chargement automatique de l'eau avec sensor de niveau • Carga automática de agua con sensor de nivel	COMBINAZIONI • Combinations / • Zusammenstellungen • Combinations / • Combinación múltiple	9,5 kW 8.160 kcal/h	3.224,00 61 / 0,4
			0,035 KW 230V~ 50/60 Hz	
CP-76G 08270650	CUOCIPASTA GAS LT 40 Vasca cm. 51x30,7x32,7h per GN 1/1. Rubinetto carico acqua, sfioratore + scarico a pavimento. • Gas pasta cooker 40 lts. Tank cm. 51x30,7x32,7h for GN 1/1, water loading cock + overflow device and floor draining • Gas-Nudelkocher lt. 40. Becken cm. 51x30,7x32,7h für GN 1/1, Wasserlauf-Hahn, + Überlauf-Vorrichtung und Ablauf am Boden • Cuiseur à pâtes gaz lt. 40. Cuve cm.51x30,7x32,7h pour GN 1/1, Robinet d'arrivée d'eau trop plein + système de vidange au sol • Cucee pasta gas 40 l. Cuba cm. 51x30,7x32,7h para GN 1/1, grifo carga agua + vertedero + descarga a pavimento cm. 60x70,5x90h		13,95 kW 11.997 kcal/h	3.259,00 80 / 0,77
CPA-76G 08270655	Carico acqua automatico con sensore di livello • Automatic Water loading with level sensor • Automatische Wasser Beladung mit Niveauregulierung • Chargement automatique de l'eau avec sensor de niveau • Carga automática de agua con sensor de nivel	COMBINAZIONI • Combinations / • Zusammenstellungen • Combinations / • Combinación múltiple	13,95 kW 11.997 kcal/h	3.483,00 80 / 0,77
			0,035 KW 230V~ 50/60 Hz	
CP-78ET 08100830	CUOCIPASTA TRIFASE LT. 25+25 2 Vasche cm. 30,5x33,5x30h per GN 2/3, rubinetto carico acqua, sfioratore + scarico a pavimento • Pasta cooker threephase 25 lts. 2 Tanks cm. 30,5x33,5x30h for GN 2/3, water loading cock + overflow device and floor draining • Nudelkocher dreiphasig lt. 25 2 Becken cm. 30,5x33,5x30h für GN 2/3, Wasserlauf-Hahn, + Überlauf-Vorrichtung und Ablauf am Boden • Cuiseur à pâtes triphase lt. 25 2 Cuves cm.30,5x33,5x30h pour GN 2/3, Robinet d'arrivée d'eau trop plein + système de vidange au sol En • Cucee pasta trifásico. 2 Cubas cm. 30,5x33,5x30h para GN 2/3, grifo carga agua + vertedero + descarga a pavimento cm. 80x70,5x90h		15,6 kW 400V~3N 50/60 Hz	4.234,00 82 / 0,77
CPA-78ET 08100835	Carico acqua automatico con sensore di livello • Automatic Water loading with level sensor • Automatische Wasser Beladung mit Niveauregulierung • Chargement automatique de l'eau avec sensor de niveau • Carga automática de agua con sensor de nivel	COMBINAZIONI • Combinations / • Zusammenstellungen • Combinations / • Combinación múltiple	15,6 kW 400V~3N 50/60 Hz	4.626,00 82 / 0,77
				

SUPERLOTUS 70

MOD. / DESCRIZIONE / DESCRIPTION / BEZEICHNUNG / DESCRIPCIÓN / POTENZA / POWER / LEISTUNG / PUISSANCE / POTENCIA / $\frac{kW}{kcal/h}$ / PREZZO / PRICE / €
 COD. / DIMENSIONI / DIMENSIONS / ABMESSUNGEN / DIMENSIONES / DIMENSIONES / VOLTAGGIO / VOLTAGE / SPANNUNG / VOLTAGE / VOLTAJE / $\frac{kW}{kcal/h}$ / PREIS / PRX / PRECIO / €

CP-78G
 08270850 CUOCIPASTA GAS LT. 25+25 2 Vasche cm. 30,5x33,5x32,7h per GN 2/3. Rubinetto carico acqua, sfioratore + scarico a pavimento
 • Gas pasta cooker 25+25 lts. 2 Tanks cm. 30,5x33,5x32,7h for GN 2/3, Water loading cock + overflow device and floor draining.
 • Gas-Nudelkocher lt. 25+25 2 Becken cm. 30,5x33,5x32,7h für GN 2/3, Wasserlauf-Hahn, + Überlauf-Vorrichtung und Ablauf am Boden
 • Cuiseur à pates gaz lt. 25+25 2 Cuves cm.30,5x33,5x32,7h pour GN 2/3, robinet d'arrivée d'eau trop plein + système de vidange au sol
 • **Cuece pasta gas 25+25 l. 2 Cubas cm. 30,5x33,5x32,7h para GN 2/3, grifo carga agua + vertedero + descarga a pavimento cm. 80x70,5x90h**



19 kW / 16.320 kcal/h
 4.695,00 / 103 / 0,77
 0,04 kW / 230V~ / 50/60 Hz

CPA-78G
 08270855 Carico acqua automatico con sensore di livello
 • Automatic Water loading with level sensor
 • Automatische Wasser Beladung mit Niveauregulierung
 • Chargement automatique de l'eau avec sensor de niveau
 • **Carga automática de agua con sensor de nivel**

COMBINAZIONI
 • Combinations / • Zusammenstellungen
 • Combinaisons
 • **Combinación múltiple**



19 kW / 16.320 kcal/h
 5.143,00 / 103 / 0,77
 0,07 kW / 230V~ / 50/60 Hz

SCCP-72EM
 08140210 SOLLEVATORE CESTI DA AFFIANCARE AI CUOCIPASTA CP-74/78, sollevamento automatico temporizzato o manuale, 2 aste
 • basket elevator for pasta cooker CP-74/78, automatic timed or manual lifting, 2 rods
 • heben Korbe für Nudelkocher CP-74/78, Timed oder manuelle Heben, 2 Stangen
 • soulever des paniers pour cuiseur a pates CP-74/78, soulèvement temporisé ou manuel, 2 tiges
 • **levante cestas para cuece pasta CP-74/78, elevación temporizado o manual, 2 barras cm. 20x70,5x90h**



COMBINAZIONI
 • Combinations / • Zusammenstellungen
 • Combinaisons / • **Combinación múltiple**

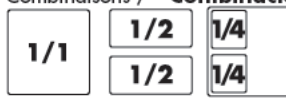

0,35 kW / 230V~ / 50/60 Hz
 2.695,00 / 45 / 0,4

PI50-78ET
 08110831 PENTOLA INDIRETTA ELETTRICA LT. 50 Vasca Ø cm. 40x45h
 • Electric indirect boiling pan 50 lts. Tank Ø cm. 40x45h
 • Indirekter Elektro-kochkessel lt. 50 Becken Ø cm. 40x45h
 • Marmite indirecte électrique lt. 50 Cuve Ø cm. 40x45h
 • **Marmita de calefacción indirecta 50 lt. Cuba Ø cm. 40x45h cm. 80x70,5x90h**



9 kW / 400V~3N / 50/60 Hz
 6.038,00 / 120 / 0,9

PI50A-78ET
 0811A831 Carico automatico intercapedine
 • Automatic water-charge of double jacket.
 • Automatische Wasserstandskontrolle im Zwischenmantel
 • Remplissage automatique dans la double paroi
 • **Carga automática de la camisa intercambiador**

9 kW / 400V~3N / 50/60 Hz
 7.871,00 / 120 / 0,9

PD50-78G
 08280850 PENTOLA DIRETTA GAS LT. 50Vasca Ø cm. 40x45h
 • Gas direct boiling pan 50 lts - Tank Ø cm. 40x45h
 • Direkter Gas-Kochkessel lt. 50 - Becken Ø cm. 40x45h
 • Marmite directe à gaz lt. 50 - Cuve Ø cm. 40x45h
 • **Marmita de calefacción directa 50 lt. Cuba Ø cm. 40x45h cm. 80x70,5x90h**



15,5 kW / 13.330 kcal/h
 4.872,00 / 110 / 0,9

PI50-78G
 08280851 PENTOLA INDIRETTA A GAS LT. 50Vasca Ø cm. 40x45h
 • Gas indirect boiling pan 50 lts. - Tank Ø cm. 40x45h
 • Indirekter Gas-Kochkessel lt. 50 - Becken Ø cm. 40x45h
 • Marmite indirecte à gaz lt. 50 - Cuve Ø cm. 40x45h
 • **Marmita de calefacción indirecta a gas lt. 50 Cuba Ø cm. 40x45h cm. 80x70,5x90h**

15,5 kW / 13.330 kcal/h
 6.319,00 / 120 / 0,9

PI50A-78G
 0828A851 Carico automatico intercapedine
 • Automatic water-charge of double jacket.
 • Automatische Wasserstandskontrolle im Zwischenmantel
 • Remplissage automatique dans la double paroi
 • **Carga automática de la camisa intercambiador**

15,5 kW / 13.330 kcal/h
 8.304,00 / 120 / 0,9
 0,1 kW / 230V~ / 50/60 Hz

531032701 OPTIONAL: Cesto 1/1 per pentola
 • Optional: Basket 1/1 for boiling pan
 • Zubehör: Korb 1/1 für Kochkessel
 • En option: Panier 1/1 pour marmite
 • **Opcional: Cesta 1/1 por marmita cm. Ø 36x39,5h**

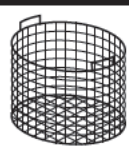

725,00 / 5 / 0,044

SUPERLOTUS 70

MOD. COD.	DESCRIZIONE/DESCRIPTION/BEZEICHNUNG/DESCRIPTION/DESCRIPCIÓN DIMENSIONI/DIMENSIONS/ABMESSUNGEN/DIMENSIONS/DIMENSIONES	POTENZA/POWER/LEISTUNG/PUISSANCE/POTENCIA VOLTAGGIO/VOLTAGE/SPANNUNG/VOLTAGE/VOLTAJE	⚡ kW kcal/h	⚡ kW V~ Hz	PREZZO/PRICE € PREIS/PRIX/PRECIO € KG / M ³
FTL-74ET 08060431	FRY-TOP LISCIO TRIFASE SU MOBILE A GIORNO Piastra cm. 36x51 • Threephase smooth griddle on open cabinet Plate cm. 36x51 • Griddleplatte glatt dreiphasig mit offenem Unterbau Platte cm. 36x51 • Plaque lisse triphase sur armoire ouvert Claque cm. 36x51 • Fry-top liso trifásico sobre mueble abierto Plancia cm. 36x51		5,55 kW 400V~3N 230V~3 50/60 Hz		1.717,00 64 / 0,4
FTR-74ET 08060433	FRY-TOP RIGATO TRIFASE SU MOBILE A GIORNO Piastra cm. 36x51 • Threephase grooved griddle on open cabinet Plate cm. 36x51 • Griddleplatte gerillt dreiphasig mit offenem Unterbau Platte cm. 36x51 • Plaque nervurée triphase sur armoire ouvert Claque cm. 36x51 • Fry-top estriado trifásico sobre mueble abierto Plancia cm. 36x51				1.831,00 64 / 0,4
FTL-74ETS 08060434	FRY-TOP LISCIO CROMATO TRIFASE SU MOBILE A GIORNO Piastra cm. 36x51 • Threephase chromed smooth griddle on open cabinet Plate cm. 36x51 • Griddleplatte glatt hartverchromt dreiphasig mit offenem Unterbau Platte cm. 36x51 • Plaque lisse chromée triphase sur armoire ouvert Claque cm. 36x51 • Fry-top liso cromado trifásico sobre mueble abierto Plancia cm. 36x51				2.048,00 64 / 0,4
FTR-74ETS 08060436	FRY-TOP RIGATO CROMATO TRIFASE SU MOBILE A GIORNO Piastra cm. 36x51 • Threephase grooved chromed griddle on open cabinet Plate cm. 36x51 • Griddleplatte gerillt hartverchromt dreiphasig mit offenem Unterbau Platte cm. 36x51 • Plaque nervurée chromée triphase sur armoire ouvert Claque cm. 36x51 • Fry-top estriado cromado trifásico sobre mueble abierto Plancia cm. 36x51 cm. 40x70,5x90h				2.120,00 64 / 0,4
FTL-74G 08230451	FRY-TOP LISCIO GAS SU MOBILE A GIORNO Piastra cm. 36x51 • Gas smooth griddle on open cabinet Plate cm. 36x51 • Gas-Griddleplatte glatt mit offenem Unterbau Platte cm. 36x51 • Plaque lisse gaz sur armoire ouvert Claque cm. 36x51 • Fry-top liso gas sobre mueble abierto Plancia cm. 36x51		7 kW 6.020 kcal/h		1.815,00 69 / 0,4
FTR-74G 08230453	FRY-TOP RIGATO GAS SU MOBILE A GIORNO Piastra cm. 36x51 • Gas grooved griddle on open cabinet Plate cm. 36x51 • Gas-Griddleplatte gerillt mit offenem Unterbau Platte cm. 36x51 • Plaque nervurée gaz sur armoire ouvert Claque cm. 36x51 • Fry-top estriado gas sobre mueble abierto Plancia cm. 36x51				1.947,00 69 / 0,4
FTL-74GS 08230454	FRY-TOP LISCIO CROMATO GAS SU MOBILE A GIORNO Piastra cm. 36x51 • Gas chromed smooth griddle on open cabinet Plate cm. 36x51 • Gas-Griddleplatte glatt hartverchromt mit offenem Unterbau Platte cm. 36x51 • Plaque lisse chromée gaz sur armoire ouvert Claque cm. 36x51 • Fry-top liso cromado gas sobre mueble abierto Plancia cm. 36x51				2.150,00 69 / 0,4
FTR-74GS 08230456	FRY-TOP RIGATO CROMATO GAS SU MOBILE A GIORNO Piastra cm. 36x51 • Gas grooved chromed griddle on open cabinet Plate cm. 36x51 • Gas-Griddleplatte gerillt hartverchromt mit offenem Unterbau Platte cm. 36x51 • Plaque nervurée chromée gaz sur armoire ouvert Claque cm. 36x51 • Fry-top estriado cromado gas sobre mueble abierto Plancia cm. 36x51 cm. 40x70,5x90h				2.276,00 69 / 0,4
FTL-76ET 08060631	FRY-TOP LISCIO TRIFASE SU MOBILE A GIORNO Piastra cm. 56x51 • Threephase smooth griddle on open cabinet Plate cm. 56x51 • Griddleplatte glatt dreiphasig mit offenem Unterbau Platte. 56x51 • Plaque lisse triphase sur armoire ouvert Claque cm. 56x51 • Fry-top liso trifásico sobre mueble abierto Plancha cm. 56x51		7,4 kW 400V~3N 50/60 Hz		2.074,00 78 / 0,5
FTLR-76ET 08060632	FRY-TOP 1/2 LISCIO + 1/2 RIGATO TRIFASE SU MOBILE A GIORNO Piastra cm. 56x51 • Threephase 1/2 smooth + 1/2 grooved griddle on open cabinet Plate cm. 56x51 • Griddleplatte 1/2 glatt + 1/2 gerillt dreiphasig mit offenem Unterbau Platte. 56x51 • Plaque 1/2 lisse + 1/2 nervurée triphase sur armoire ouvert Claque cm. 56x51 • Fry-top 1/2 liso + 1/2 estriado trifásico sobre mueble abierto Plancha cm. 56x51 cm. 60x70,5x90h				2.138,00 78 / 0,5

SUPERLOTUS 70







MOD. COD.	DESCRIZIONE/DESCRIPTION/BEZEICHNUNG/DESCRIPTION/DESCRIPCIÓN DIMENSIONI/DIMENSIONS/ABMESSUNGEN/DIMENSIONS/DIMENSIONES	POTENZA/POWER/LEISTUNG/PUISSANCE/POTENCIA VOLTAGGIO/VOLTAGE/SPANNUNG/VOLTAGE/VOLTAJE	6kW kcal/h	7kW V~ Hz	PREZZO/PRICE € PREIS/PRIX/PRECIO € KG / M³
FTR-76ET 08060633	<p>FRY-TOP RIGATO TRIFASE SU MOBILE A GIORNO Piastra cm. 56x51</p> <ul style="list-style-type: none"> • Threephase grooved griddle on open cabinet Plate cm. 56x51 • Griddleplatte gerillt dreiphasig mit offenem Unterbau Platte. 56x51 • Plaque nervurée triphase sur armoire ouvert Plaque cm. 56x51 • Fry-top estriado trifásico sobre mueble abierto Plancha cm. 56x51 		7,4 kW	400V~3N 50/60 Hz	2.207,00 78 / 0,5
FTL-76ETS 08060634	<p>FRY-TOP LISCIO CROMATO TRIFASE SU MOBILE A GIORNO Piastra cm. 56x51</p> <ul style="list-style-type: none"> • Threephase chromed smooth griddle on open cabinet Plate cm. 56x51 • Griddleplatte glatt hartverchromt dreiphasig mit offenem Unterbau Platte. 56x51 • Plaque lisse chromée triphase sur armoire ouvert Plaque cm. 56x51 • Fry-top liso cromado trifásico sobre mueble abierto Plancha cm. 56x51 				2.417,00 78 / 0,5
FTLR-76ETS 08060635	<p>FRY-TOP 1/2 LISCIO + 1/2 RIGATO CROMATO TRIFASE SU MOBILE A GIORNO Piastra cm. 56x51</p> <ul style="list-style-type: none"> • Threephase 1/2 smooth + 1/2 grooved chromed griddle on open cabinet Plate cm. 56x51 • Griddleplatte 1/2 glatt + 1/2 gerillt hartverchromt dreiphasig mit offenem Unterbau Platte. 56x51 • Plaque 1/2 lisse + 1/2 nervurée chromée triphase sur armoire ouvert Plaque cm. 56x51 • Fry-top 1/2 liso + 1/2 estriado cromado trifásico sobre mueble abierto Plancha cm. 56x51 				2.523,00 78 / 0,5
FTR-76ETS 08060636	<p>FRY-TOP RIGATO CROMATO TRIFASE SU MOBILE A GIORNO Piastra cm. 56x51</p> <ul style="list-style-type: none"> • Threephase grooved chromed griddle on open cabinet Plate cm. 56x51 • Griddleplatte gerillt hartverchromt dreiphasig mit offenem Unterbau Platte. 56x51 • Plaque nervurée chromée triphase sur armoire ouvert Plaque cm. 56x51 • Fry-top estriado cromado trifásico sobre mueble abierto Plancha cm. 56x51 cm. 60x70,5x90h 				2.632,00 78 / 0,5
FTL-76G 08230651	<p>FRY-TOP LISCIO GAS SU MOBILE A GIORNO Piastra cm. 56x51</p> <ul style="list-style-type: none"> • Gas smooth griddle on open cabinet Plate cm. 56x51 • Gas-Griddleplatte glatt mit offenem Unterbau Platte. 56x51 • Plaque lisse gaz sur armoire ouvert Plaque cm. 56x51 • Fry-top liso gas sobre mueble abierto Plancha cm. 56x51 		10,5 kW 9.030 kcal/h		2.124,00 83 / 0,5
FTLR-76G 08230652	<p>FRY-TOP 1/2 LISCIO + 1/2 RIGATO GAS SU MOBILE A GIORNO Piastra cm. 56x51</p> <ul style="list-style-type: none"> • Gas 1/2 smooth + 1/2 grooved griddle on open cabinet Plate cm. 56x51 • Gas-Griddleplatte 1/2 glatt + 1/2 gerillt mit offenem Unterbau Platte. 56x51 • Plaque 1/2 lisse + 1/2 nervurée gaz sur armoire ouvert Plaque cm. 56x51 • Fry-top 1/2 liso + 1/2 estriado gas sobre mueble abierto Plancha cm. 56x51 				2.229,00 83 / 0,5
FTR-76G 08230653	<p>FRY-TOP RIGATO GAS SU MOBILE A GIORNO Piastra cm. 56x51</p> <ul style="list-style-type: none"> • Gas grooved griddle on open cabinet Plate cm. 56x51 • Gas-Griddleplatte gerillt mit offenem Unterbau Platte. 56x51 • Plaque nervurée gaz sur armoire ouvert Plaque cm. 56x51 • Fry-top estriado gas sobre mueble abierto Plancha cm. 56x51 				2.323,00 83 / 0,5
FTL-76GS 08230654	<p>FRY-TOP LISCIO CROMATO GAS SU MOBILE A GIORNO Piastra cm. 56x51</p> <ul style="list-style-type: none"> • Gas chromed smooth griddle on open cabinet Plate cm. 56x51 • Gas-Griddleplatte glatt hartverchromt mit offenem Unterbau Platte. 56x51 • Plaque lisse chromée triphase sur armoire ouvert Plaque cm. 56x51 • Fry-top liso cromado gas sobre mueble abierto Plancha cm. 56x51 cm. 60x70,5x90h 				2.588,00 83 / 0,5



SUPERLOTUS 70







MOD. COD.	DESCRIZIONE/DESCRIPTION/BEZEICHNUNG/DESCRIPTION/DESCRIPCIÓN DIMENSIONI/DIMENSIONS/ABMESSUNGEN/DIMENSIONS/DIMENSIONES	POTENZA/POWER/LEISTUNG/PUISSANCE/POTENCIA VOLTAGGIO/VOLTAGE/SPANNUNG/VOLTAGE/VOLTAGE	$\frac{kW}{kcal/h}$ $\frac{kw}{V_{\sim}}$	PREZZO/PRICE € PREIS/PRIX/PRECIO € KG / M ³
FTL-76GS 08230655	FRY-TOP 1/2 LISCIO + 1/2 RIGATO CROMATO GAS SU MOBILE A GIORNO Piastra cm. 56x51 • Gas 1/2 smooth + 1/2 grooved chromed griddle on open cabinet Plate cm. 56x51 • Gas-Griddleplatte 1/2 glatt + 1/2 gerillt hartverchromt mit offenem Unterbau Platte. 56x51 • Plaque 1/2 lisse + 1/2 nervurée chromée gaz sur armoire ouvert Plaque cm. 56x51 • Fry-top 1/2 liso + 1/2 estriado cromado gas sobre mueble abierto Plancha cm. 56x51		$\frac{10,5}{9.030}$	2.696,00 83 / 0,5
FTR-76GS 08230656	FRY-TOP RIGATO CROMATO GAS SU MOBILE A GIORNO Piastra cm. 56x51 • Gas grooved chromed griddle on open cabinet Plate cm. 56x51 • Gas-Griddleplatte gerillt hartverchromt mit offenem Unterbau Platte. 56x51 • Plaque nervurée chromée gaz sur armoire ouvert Plaque cm. 56x51 • Fry-top estriado cromado gas sobre mueble abierto Plancha cm. 56x51 cm. 60x70,5x90h			2.784,00 83 / 0,5
FTL-78ET 08060831	FRY-TOP LISCIO TRIFASE SU MOBILE A GIORNO Piastra cm. 76x51 - 2 zone di cottura • Threephase smooth griddle on open cabinet Plate cm. 76x51 - 2 cooking areas • Griddleplatte glatt dreiphasig mit offenem Unterbau Platte cm. 76x51 - 2 Heizzonen • Plaque lisse triphase sur armoire ouvert Plaque cm. 76x51 - 2 zones de cuisson • Fry-top liso trifásico sobre mueble abierto Plancha cm. 76x51 - 2 zonas de cocción		$\frac{11,1}{400V\sim 3N}$ $\frac{230V\sim 3}{50/60}$	2.564,00 110 / 0,77
FTLR-78ET 08060832	FRY-TOP 1/2 LISCIO + 1/2 RIGATO TRIFASE SU MOBILE A GIORNO Piastra cm. 76x51 - 2 zone di cottura • Threephase 1/2 smooth + 1/2 grooved griddle on open cabinet Plate cm. 76x51 - 2 cooking areas • Griddleplatte 1/2 glatt + 1/2 gerillt dreiphasig mit offenem Unterbau Platte cm. 76x51 - 2 Heizzonen • Plaque 1/2 lisse + 1/2 nervurée triphase sur armoire ouvert Plaque cm. 76x51 - 2 zones de cuisson • Fry-top 1/2 liso + 1/2 estriado trifásico sobre mueble abierto Plancha cm. 76x51 - 2 zonas de cocción			2.714,00 110 / 0,77
FTR-78ET 08060833	FRY-TOP RIGATO TRIFASE SU MOBILE A GIORNO Piastra cm. 76x51 - 2 zone di cottura • Threephase grooved griddle on open cabinet Plate cm. 76x51 - 2 cooking areas • Griddleplatte gerillt dreiphasig mit offenem Unterbau Platte cm. 76x51 - 2 Heizzonen • Plaque nervurée triphase sur armoire ouvert Plaque cm. 76x51 - 2 zones de cuisson • Fry-top estriado trifásico sobre mueble abierto Plancha cm. 76x51 - 2 zonas de cocción			2.778,00 110 / 0,77
FTL-78ETS 08060834	FRY-TOP LISCIO CROMATO TRIFASE SU MOBILE A GIORNO Piastra cm. 76x51 - 2 zone di cottura • Threephase chromed smooth griddle on open cabinet Plate cm. 76x51 - 2 cooking areas • Griddleplatte glatt hartverchromt dreiphasig mit offenem Unterbau Platte cm. 76x51 - 2 Heizzonen • Plaque lisse chromée triphase sur armoire ouvert Plaque cm. 76x51 - 2 zones de cuisson • Fry-top liso cromado trifásico sobre mueble abierto Plancha cm. 76x51 - 2 zonas de cocción			3.050,00 110 / 0,77
FTLR-78ETS 08060835	FRY-TOP 1/2 LISCIO + 1/2 RIGATO CROMATO TRIFASE SU MOBILE A GIORNO Piastra cm. 76x51 - 2 zone di cottura • Threephase 1/2 smooth + 1/2 grooved griddle on open cabinet Plate cm. 76x51 - 2 cooking areas • Griddleplatte 1/2 glatt + 1/2 gerillt dreiphasig mit offenem Unterbau Platte cm. 76x51 - 2 Heizzonen • Plaque 1/2 lisse + 1/2 nervurée triphase sur armoire ouvert Plaque cm. 76x51 - 2 zones de cuisson • Fry-top 1/2 liso + 1/2 estriado trifásico sobre mueble abierto Plancha cm. 76x51 - 2 zonas de cocción			3.175,00 110 / 0,77
FTR-78ETS 08060836	FRY-TOP RIGATO CROMATO TRIFASE SU MOBILE A GIORNO Piastra cm. 76x51 - 2 zone di cottura • Threephase grooved chromed griddle on open cabinet Plate cm. 76x51 - 2 cooking areas • Griddleplatte gerillt hartverchromt dreiphasig mit offenem Unterbau Platte cm. 76x51 - 2 Heizzonen • Plaque nervurée chromée triphase sur armoire ouvert Plaque cm. 76x51 - 2 zones de cuisson • Fry-top estriado cromado trifásico sobre mueble abierto Plancha cm. 76x51 - 2 zonas de cocción cm. 80x70,5x90h			3.311,00 110 / 0,77

SUPERLOTUS 70







MOD. COD.	DESCRIZIONE/DESCRIPTION/BEZEICHNUNG/DESCRIPTION/DESCRIPCIÓN DIMENSIONI/DIMENSIONS/ABMESSUNGEN/DIMENSIONS/DIMENSIONES	POTENZA/POWER/LEISTUNG/PUISSANCE/POTENCIA VOLTAGGIO/VOLTAGE/SPANNUNG/VOLTAGE/VOLTAJE	6kW kcal/h	7kW V~ Hz	PREZZO/PRICE € PREIS/PRIX/PRECIO € KG / M ³
FTL-78G 08230851	<p>FRY-TOP LISCIO GAS SU MOBILE A GIORNO Piastra cm. 76x51 - 2 zone di cottura</p> <ul style="list-style-type: none"> Gas smooth griddle on open cabinet Plate cm. 76x51 - 2 cooking areas Gas-Griddleplatte glatt mit offenem Unterbau Platte cm. 76x51 - 2 Heizzonen Plaque lisse gaz sur armoire ouvert Plaque cm. 76x51 - 2 zones de cuisson Fry-top liso gas sobre mueble abierto Plancha cm. 76x51 - 2 zonas de cocción 		14 kW 12.040 kcal/h		2.918,00 114 / 0,77
					
FTLR-78G 08230852	<p>FRY-TOP 1/2 LISCIO + 1/2 RIGATO GAS SU MOBILE A GIORNO Piastra cm. 76x51 - 2 zone di cottura</p> <ul style="list-style-type: none"> Gas 1/2 smooth + 1/2 grooved griddle on open cabinet Plate cm. 76x51 - 2 cooking areas Gas-Griddleplatte 1/2 glatt + 1/2 gerillt mit offenem Unterbau Platte cm. 76x51 - 2 Heizzonen Plaque 1/2 lisse + 1/2 nervurée gaz sur armoire ouvert Plaque cm. 76x51 - 2 zones de cuisson Fry-top 1/2 liso + 1/2 estriado gas sobre mueble abierto Plancha cm. 76x51 - 2 zonas de cocción 				3.065,00 114 / 0,77
					
FTR-78G 08230853	<p>FRY-TOP RIGATO GAS SU MOBILE A GIORNO Piastra cm. 76x51 - 2 zone di cottura</p> <ul style="list-style-type: none"> Gas grooved griddle on open cabinet Plate cm. 76x51 - 2 cooking areas Gas-Griddleplatte gerillt mit offenem Unterbau Platte cm. 76x51 - 2 Heizzonen Plaque nervurée gaz sur armoire ouvert Plaque cm. 76x51 - 2 zones de cuisson Fry-top estriado gas sobre mueble abierto Plancha cm. 76x51 - 2 zonas de cocción 				3.208,00 114 / 0,77
					
FTL-78GS 08230854	<p>FRY-TOP LISCIO CROMATO GAS SU MOBILE A GIORNO Piastra cm. 76x51 - 2 zone di cottura</p> <ul style="list-style-type: none"> Gas chromed smooth griddle on open cabinet Plate cm. 76x51 - 2 cooking areas Gas-Griddleplatte glatt hartverchromt mit offenem Unterbau Platte cm. 76x51 - 2 Heizzonen Plaque lisse chromée triphase sur armoire ouvert Plaque cm. 76x51 - 2 zones de cuisson Fry-top liso cromado gas sobre mueble abierto Plancha cm. 76x51 - 2 zonas de cocción 				3.445,00 114 / 0,77
					
FTLR-78GS 08230855	<p>FRY-TOP 1/2 LISCIO + 1/2 RIGATO CROMATO GAS SU MOBILE A GIORNO Piastra cm. 76x51 - 2 zone di cottura</p> <ul style="list-style-type: none"> Gas 1/2 smooth + 1/2 grooved chromed griddle on open cabinet Plate cm. 76x51 - 2 cooking areas Gas-Griddleplatte 1/2 glatt + 1/2 gerillt hartverchromt mit offenem Unterbau Platte cm. 76x51 - 2 Heizzonen Plaque 1/2 lisse + 1/2 nervurée chromée gaz sur armoire ouvert Plaque cm. 76x51 - 2 zones de cuisson Fry-top 1/2 liso + 1/2 estriado cromado gas sobre mueble abierto Plancha cm. 76x51 - 2 zonas de cocción 				3.594,00 114 / 0,77
					
FTR-78GS 08230856	<p>FRY-TOP RIGATO CROMATO GAS SU MOBILE A GIORNO Piastra cm. 76x51 - 2 zone di cottura</p> <ul style="list-style-type: none"> Gas grooved chromed griddle on open cabinet Plate cm. 76x51 - 2 cooking areas Gas-Griddleplatte gerillt hartverchromt mit offenem Unterbau Platte cm. 76x51 - 2 Heizzonen Plaque nervurée chromée gaz sur armoire ouvert Plaque cm. 76x51 - 2 zones de cuisson Fry-top estriado cromado gas sobre mueble abierto Plancha cm. 76x51 - 2 zonas de cocción <p>cm. 80x70,5x90h</p>				3.751,00 114 / 0,77
					



SUPERLOTUS 70

MOD. COD.	DESCRIZIONE/DESCRIPTION/BEZEICHNUNG/DESCRIPTION/DESCRIPCIÓN DIMENSIONI/DIMENSIONS/ABMESSUNGEN/DIMENSIONS/DIMENSIONES	POTENZA/POWER/LEISTUNG/PUISSANCE/POTENCIA VOLTAGGIO/VOLTAGE/SPANNUNG/VOLTAGE/VOLTAGE	$\frac{kW}{kcal/h}$ $\frac{V}{Hz}$	PREZZO/PRICE € PREIS/PRIX/PRECIO € KG / M ³
FTL-712ET 08061231	<p>FRY-TOP LISCIO TRIFASE SU MOBILE A GIORNO Piastra cm. 116x51 - 2 zone di cottura</p> <ul style="list-style-type: none"> • Threephase smooth griddle on open cabinet Plate cm. 116x51 - 2 cooking areas • Griddleplatte glatt dreiphasig mit offenem Unterbau Platte cm. 116x51 - 2 Heizzonen • Plaque lisse triphase sur armoire ouvert Plaque cm. 116x51 - 2 zones de cuisson • Fry-top liso trifásico sobre mueble abierto Plancha cm. 116x51 - 2 zonas de cocción 		$\frac{14,8 kW}{400V \sim 3N}$ 50/60 Hz	3.259,00 150 / 1,14
				
FTLR-712ET 08061232	<p>FRY-TOP 1/2 LISCIO + 1/2 RIGATO TRIFASE SU MOBILE A GIORNO Piastra cm. 116x51 - 2 zone di cottura</p> <ul style="list-style-type: none"> • Threephase 1/2 smooth + 1/2 grooved griddle on open cabinet Plate cm. 116x51 - 2 cooking areas • Griddleplatte 1/2 glatt + 1/2 gerillt dreiphasig mit offenem Unterbau Platte cm. 116x51 - 2 Heizzonen • Plaque 1/2 lisse + 1/2 nervurée triphase sur armoire ouvert Plaque cm. 116x51 - 2 zones de cuisson • Fry-top 1/2 liso + 1/2 estriado trifásico sobre mueble abierto Plancha cm. 116x51 - 2 zonas de cocción 			3.410,00 150 / 1,14
				
FTR-712ET 08061233	<p>FRY-TOP RIGATO TRIFASE SU MOBILE A GIORNO Piastra cm. 116x51 - 2 zone di cottura</p> <ul style="list-style-type: none"> • Threephase grooved griddle on open cabinet Plate cm. 116x51 - 2 cooking areas • Griddleplatte gerillt dreiphasig mit offenem Unterbau Platte cm. 116x51 - 2 Heizzonen • Plaque nervurée triphase sur armoire ouvert Plaque cm. 116x51 - 2 zones de cuisson • Fry-top estriado trifásico sobre mueble abierto Plancha cm. 116x51 - 2 zonas de cocción 			3.570,00 150 / 1,14
				
FTL-712ETS 08061234	<p>FRY-TOP LISCIO CROMATO TRIFASE SU MOBILE A GIORNO Piastra cm. 116x51 - 2 zone di cottura</p> <ul style="list-style-type: none"> • Threephase chromed smooth griddle on open cabinet Plate cm. 116x51 - 2 cooking areas • Griddleplatte glatt hartverchromt dreiphasig mit offenem Unterbau Platte cm. 116x51 - 2 Heizzonen • Plaque lisse chromée triphase sur armoire ouvert Plaque cm. 116x51 - 2 zones de cuisson • Fry-top liso cromado trifásico sobre mueble abierto Plancha cm. 116x51 - 2 zonas de cocción 			4.007,00 150 / 1,14
				
FTLR-712ETS 08061235	<p>FRY-TOP 1/2 LISCIO + 1/2 RIGATO CROMATO TRIFASE SU MOBILE A GIORNO Piastra cm. 116x51 - 2 zone di cottura</p> <ul style="list-style-type: none"> • Threephase 1/2 smooth + 1/2 grooved chromed griddle on open cabinet Plate cm. 116x51 - 2 cooking areas • Griddleplatte 1/2 glatt + 1/2 gerillt hartverchromt dreiphasig mit offenem Unterbau Platte cm. 116x51 - 2 Heizzonen • Plaque 1/2 lisse + 1/2 nervurée chromée triphase sur armoire ouvert Plaque cm. 116x51 - 2 zones de cuisson • Fry-top 1/2 liso + 1/2 estriado cromado trifásico sobre mueble abierto Plancha cm. 116x51 - 2 zonas de cocción 			4.236,00 150 / 1,14
				
FTR-712ETS 08061236	<p>FRY-TOP RIGATO CROMATO TRIFASE SU MOBILE A GIORNO Piastra cm. 116x51 - 2 zone di cottura</p> <ul style="list-style-type: none"> • Threephase grooved chromed griddle on open cabinet Plate cm. 116x51 - 2 cooking areas • Griddleplatte gerillt hartverchromt dreiphasig mit offenem Unterbau Platte cm. 116x51 - 2 Heizzonen • Plaque nervurée chromée triphase sur armoire ouvert Plaque cm. 116x51 - 2 zones de cuisson • Fry-top estriado cromado trifásico sobre mueble abierto Plancha cm. 116x51 - 2 zonas de cocción cm. 120x70,5x90h 			4.531,00 150 / 1,14
				

SUPERLOTUS 70

MOD. COD.	DESCRIZIONE/DESCRIPTION/BEZEICHNUNG/DESCRIPTION/DESCRIPCIÓN DIMENSIONI/DIMENSIONS/ABMESSUNGEN/DIMENSIONS/DIMENSIONES	POTENZA/POWER/LEISTUNG/PUISSANCE/POTENCIA VOLTAGGIO/VOLTAGE/SPANNUNG/VOLTAGE/VOLTAJE	6 kW kcal/h	7 kW V~ Hz	PREZZO/PRICE € PREIS/PRIX/PRECIO € KG / M²
FTL-712G 08231251	<p>FRY-TOP LISCIO GAS SU MOBILE A GIORNO Piastra cm. 116x51 - 2 zone di cottura</p> <ul style="list-style-type: none"> Gas smooth griddle on open cabinet Plate cm. 116x51 - 2 cooking areas Gas-Griddleplatte glatt mit offenem Unterbau Platte cm. 116x51 - 2 Heizzonen Plaque lisse gaz sur armoire ouvert Plaque cm. 116x51 - 2 zones de cuisson Fry-top liso gas sobre mueble abierto Plancha cm. 116x51 - 2 zonas de cocción 		21 kW 18.060 kcal/h		3.678,00 154 / 1,14
					
FTLR-712G 08231252	<p>FRY-TOP 1/2 LISCIO + 1/2 RIGATO GAS SU MOBILE A GIORNO Piastra cm. 116x51 - 2 zone di cottura</p> <ul style="list-style-type: none"> Gas 1/2 smooth + 1/2 grooved griddle on open cabinet Plate cm. 116x51 - 2 cooking areas Gas-Griddleplatte 1/2 glatt + 1/2 gerillt mit offenem Unterbau Platte cm. 116x51 - 2 Heizzonen Plaque 1/2 lisse + 1/2 nervurée gaz sur armoire ouvert Plaque cm. 116x51 - 2 zones de cuisson Fry-top 1/2 liso + 1/2 estriado gas sobre mueble abierto Plancha cm. 116x51 - 2 zonas de cocción 				3.863,00 154 / 1,14
					
FTR-712G 08231253	<p>FRY-TOP RIGATO GAS SU MOBILE A GIORNO Piastra cm. 116x51 - 2 zone di cottura</p> <ul style="list-style-type: none"> Gas grooved griddle on open cabinet Plate cm. 116x51 - 2 cooking areas Gas-Griddleplatte gerillt mit offenem Unterbau Platte cm. 116x51 - 2 Heizzonen Plaque nervurée gaz sur armoire ouvert Plaque cm. 116x51 - 2 zones de cuisson Fry-top estriado gas sobre mueble abierto Plancha cm. 116x51 - 2 zonas de cocción 				4.050,00 154 / 1,14
					
FTL-712GS 08231254	<p>FRY-TOP LISCIO CROMATO GAS SU MOBILE A GIORNO Piastra cm. 116x51 - 2 zone di cottura</p> <ul style="list-style-type: none"> Gas chromed smooth griddle on open cabinet Plate cm. 116x51 - 2 cooking areas Gas-Griddleplatte glatt hartverchromt mit offenem Unterbau Platte cm. 116x51 - 2 Heizzonen Plaque lisse chromée triphase sur armoire ouvert Plaque cm. 116x51 - 2 zones de cuisson Fry-top liso cromado gas sobre mueble abierto Plancha cm. 116x51 - 2 zonas de cocción 				4.344,00 154 / 1,14
					
FTLR-712GS 08231255	<p>FRY-TOP 1/2 LISCIO + 1/2 RIGATO CROMATO GAS SU MOBILE A GIORNO Piastra cm. 116x51 - 2 zone di cottura</p> <ul style="list-style-type: none"> Gas 1/2 smooth + 1/2 grooved chromed griddle on open cabinet Plate cm. 116x51 - 2 cooking areas Gas-Griddleplatte 1/2 glatt + 1/2 gerillt hartverchromt mit offenem Unterbau Platte cm. 116x51 - 2 Heizzonen Plaque 1/2 lisse + 1/2 nervurée chromée gaz sur armoire ouvert Plaque cm. 116x51 - 2 zones de cuisson Fry-top 1/2 liso + 1/2 estriado cromado gas sobre mueble abierto Plancha cm. 116x51 - 2 zonas de cocción 				4.495,00 154 / 1,14
					
FTR-712GS 08231256	<p>FRY-TOP RIGATO CROMATO GAS SU MOBILE A GIORNO Piastra cm. 116x51 - 2 zone di cottura</p> <ul style="list-style-type: none"> Gas grooved chromed griddle on open cabinet Plate cm. 116x51 - 2 cooking areas Gas-Griddleplatte gerillt hartverchromt mit offenem Unterbau Platte cm. 116x51 - 2 Heizzonen Plaque nervurée chromée gaz sur armoire ouvert Plaque cm. 116x51 - 2 zones de cuisson Fry-top estriado cromado gas sobre mueble abierto Plancha cm. 116x51 - 2 zonas de cocción 				4.692,00 154 / 1,14
					

SUPERLOTUS 70

MOD. COD.	DESCRIZIONE/DESCRIPTION/BEZEICHNUNG/DESCRIPTION/DESCRIPCIÓN DIMENSIONI/DIMENSIONS/ABMESSUNGEN/DIMENSIONS/DIMENSIONES	POTENZA/POWER/LEISTUNG/PUISSANCE/POTENCIA VOLTAGGIO/VOLTAGE/SPANNUNG/VOLTAGE/VOLTAGE	$\frac{kW}{kcal/h}$ $\frac{V}{Hz}$	PREZZO/PRICE € PREIS/PRIX/PRECIO € KG / M ³
FTC-74ET 08060437	<p>FRY-TOP VETROCERAMICA TRIFASE SU MOBILE A GIORNO Piastra cm. 36x51</p> <ul style="list-style-type: none"> • Ceramic glass threephase griddle on open cabinet Plate cm. 36x51 • Griddleplatte Ceran-Kochplatten dreiphasig mit offenem Unterbau Platte cm. 36x51 • Plaque vitroceramique triphase sur armoire ouvert Claque cm. 36x51 • Fry-top vitroceramica trifásico sobre mueble abierto Plancia cm. 36x51 cm. 40x70,5x90h 		$\frac{2,7}{400V\sim 3N}$ $\frac{230V\sim 3}{230V\sim}$ $\frac{50/60}{Hz}$	1.887,00 62 / 0,4
FTC-78ET 08060837	<p>FRY-TOP VETROCERAMICA TRIFASE SU MOBILE A GIORNO Piastra cm. 76x51 - 2 zone di cottura</p> <ul style="list-style-type: none"> • Threephase ceramic glass griddle on open cabinet Plate cm. 76x51 - 2 cooking areas • Griddleplatte Ceran-Kochplatten dreiphasig mit offenem Unterbau Platte cm. 76x51 - 2 Heizzonen • Plaque vitroceramique triphase sur armoire ouvert Plaque cm. 76x51 - 2 zones de cuisson • Fry-top vitroceramica trifásico sobre mueble abierto Plancha cm. 76x51 - 2 zonas de cocción cm. 80x70,5x90h 		$\frac{5,4}{400V\sim 3N}$ $\frac{230V\sim 3}{230V\sim}$ $\frac{50/60}{Hz}$	2.967,00 110 / 0,77
RSFT-73EM 18630317	<p>Piastra per sandwich sopra frytop Piastra cm. 29x40 (ATTENZIONE: PROFONDITA' MACCHINA +cm.7)</p> <ul style="list-style-type: none"> • Sandwiches plate above griddle - plate cm. 29x40 (ATTENTION: DEPTH MACHINE +cm.7) • Sandwiches Platte über Griddle - platte cm. 29x40 (VORSICHT: TIEFE MACHINE +cm.7) • Plaque pour sandwiches au-dessus fry-top - plaque cm. 29x40 (ATTENTION: PROFONDEUR MACHINE +cm.7) • Plancia para sándwiches sobre fry-top - plancia cm. 29x40 (ATENCIÓN: PROFUNDIDAD MÁQUINA +cm.7) cm. 32x62x41h 		$\frac{2,9}{230V\sim}$ $\frac{50/60}{Hz}$	984,00 20 / 0,18

SUPERLOTUS 70

MOD. COD.	DESCRIZIONE/DESCRIPTION/BEZEICHNUNG/DESCRIPTION/DESCRIPCIÓN DIMENSIONI/DIMENSIONS/ABMESSUNGEN/DIMENSIONS/DIMENSIONES	POTENZA/POWER/LEISTUNG/PUISSANCE/POTENCIA VOLTAGGIO/VOLTAGE/SPANNUNG/VOLTAGE/VOLTAJE	⚡ kW kcal/h	⚡ kw V~ Hz	PREZZO/PRICE € PREIS/PRIX/PRECIO € KG / M ³
CW-74ET 08080430	<p>GRIGLIA TRIFASE SU MOBILE A GIORNO Griglia in acciaio inox cm. 38x52 regolabile</p> <ul style="list-style-type: none"> • Grill threephase on open cabinet Stainless steel grill cm. 38x52 • Wurstbrater dreiphasig mit offenem Unterbau Einstellbarer Rost aus Nirosta cm. 38x52 • Grillade triphase sur armoire ouvert Grille inox cm 38x52 <p>Parrilla trifásico sobre mueble abierto Parrilla de acero inox regulable cm 38x52 cm. 40x70,5x90h</p>		6 kW 400V~3N 230V~3 50/60 Hz		1.932,00 62 / 0,4
CW-74G 08250450	<p>GRIGLIA GAS-PIETRALAVICA SU MOBILE A GIORNO Griglia in acciaio inox cm. 38x52 regolabile</p> <ul style="list-style-type: none"> • Charcoal grill gas on open cabinet Stainless steel grill cm. 38x52 • Gas-Lavasteingrill mit offenem Unterbau Einstellbarer Rost aus Nirosta cm. 38x52 • Grille à gaz en pierre de lave sur armoire ouvert Grille inox cm 38x52 <p>Parrilla a gas piedra lávica sobre mueble abierto Parrilla de acero inox regulable cm 38x52 cm. 40x70,5x90h</p>		9 kW 7.740 kcal/h		2.031,00 61 / 0,4
CW-78ET 08080830	<p>GRIGLIA TRIFASE SU MOBILE A GIORNO N. 2 griglie in acciaio inox cm. 38x52 regolabili 2 zone di cottura</p> <ul style="list-style-type: none"> • Grill threephase on open cabinet N. 2 Stainless steel grill cm. 38x52. 2 cooking areas • Wurstbrater dreiphasig mit offenem Unterbau - Nr. 2 einstellbare Roste aus Nirosta cm. 38x52 - 2 Heizzonen • Grillade triphase sur armoire ouvert N. 2 grilles réglables en acier inox cm. 38x52 2 zones de cuisson <p>Parrilla trifásico sobre mueble abierto - N. 2 Parrillas de acero inox regulable cm 38x52 - 2 zonas de cocción cm. 80x70,5x90h</p>		12 kW 400V~3N 230V~3 50/60 Hz		2.720,00 94 / 0,77
CW-78G 08250850	<p>GRIGLIA GAS-PIETRALAVICA SU MOBILE A GIORNO N. 2 griglie in acciaio inox cm. 38x52 regolabili 2 zone di cottura.</p> <ul style="list-style-type: none"> • Charcoal grill gas on open cabinet N. 2 Stainless steel grill cm. 38x52. 2 cooking areas • Gas-Lavasteingrill mit offenem Unterbau - N. 2 einstellbare Roste aus Nirosta cm. 38x52 - 2 Heizzonen • Grille a gaz en pierre de lave sur armoire ouvert. N. 2 grilles réglables en acier inox cm. 38x52. 2 zones de cuisson <p>Parrilla a gas piedra lávica sobre mueble abierto N. 2 Parrillas de acero inox regulable cm 38x52 2 zonas de cocción cm. 80x70,5x90h</p>		18 kW 15.480 kcal/h		3.052,00 104 / 0,77
CWK-74ET 08080431	<p>GRIGLIA CONTACT SU MOBILE A GIORNO cottura diretta su resistenza in acciaio inox cm. 27x43 ribaltabile</p> <ul style="list-style-type: none"> • CONTACT Grill threephase on open cabinet rotatable stainless steel grill cm. 27x43 • Wurstbrater dreiphasig KONTAKT mit offenem Unterbau Drehbaren Heizelement aus Edelstahl cm. 27x43 • Grillade triphase CONTACT sur armoire ouvert Grille inoxrotatif cm 27x43 <p>Parrilla trifásico CONTACT sobre mueble abierto Parrilla giratoria de acero inox cm 27x43 cm. 40x70,5x90h</p>		4,08 KW 400V~3N 50/60 Hz		2.607,00 60 / 0,4
CWK-78ET 08080831	<p>GRIGLIA CONTACT SU MOBILE A GIORNO cottura diretta su resistenza in acciaio inox cm. 55x43 ribaltabile - 2 zone cottura</p> <ul style="list-style-type: none"> • CONTACT Grill threephase on open cabinet - rotatable stainless steel grill cm. 55x43 - 2 cooking areas • Wurstbrater dreiphasig KONTAKT mit offenem Unterbau - Drehbaren Heizelement aus Edelstahl cm.. 55x43 - 2 Heizzonen • Grillade triphase CONTACT sur armoire ouvert - Grille inoxrotatif cm 55x43 - 2 zones de cuisson <p>Parrilla trifásico CONTACT sobre mueble abierto - Parrilla giratoria de acero inox cm 55x43 - 2 zonas de cocción cm. 80x70,5x90h</p>		8,16 KW 400V~3N 50/60 Hz		3.367,00 90 / 0,77

SUPERLOTUS 70

MOD. COD.	DESCRIZIONE/DESCRIPTION/BEZEICHNUNG/DESCRIPTION/DESCRIPCIÓN DIMENSIONI/DIMENSIONS/ABMESSUNGEN/DIMENSIONS/DIMENSIONES	POTENZA/POWER/LEISTUNG/PUISSANCE/POTENCIA VOLTAGGIO/VOLTAGE/SPANNUNG/VOLTAGE/VOLTAJE	$\frac{kW}{kcal/h}$ $\frac{V}{Hz}$	PREZZO/PRICE € PREIS/PRIX/PRECIO € KG / M ³
F13-74ET 08090430	FRIGGITRICE TRIFASE LT. 13 - Vasca cm. 24x35x38h 1 cesto cm. 21x30x12h - Filtro e coperchio vasca. Bacinella raccogliolio con filtro. Produzione patate: 10 kg/h <ul style="list-style-type: none"> Fryer threephase 13 lts - Bowl cm. 24x35x38h - 1 basket cm. 21x30x12h. Sieve and lid for pan. Drip tray with sieve. Production: 10 kg/h Friteuse dreiphasig lt. 13 - Becken cm. 24x35x38h - 1 Korb cm. 21x30x12h. Einlegesieb und Deckel für Becken. Fettauffangschale mit Sieb. Pommes frites: 10 kg/h Friteuse triphase lt. 13 - Cuve cm. 24x35x38h - 1 Panier cm. 21x30x12h. Filtre, couvercle pour cuve. Bac de récupération de l'huile avec filtre. Production de pommes frites: 10 kg/h Freidoras trifásico 13 lt. - Cuba cm. 24x35x38h - 1 cesta cm. 21x30x12h. Filtro y tapa para cuba. Bandeja recoge aceite con filtro. Prod. patatas: 10 Kg/h cm. 40x70,5x90h		$\frac{11,95 kW}{400V\sim 3N}$ 50/60 Hz	1.989,00 54 / 0,4
F18-74ET 08090431	FRIGGITRICE TRIFASE LT. 18 - Vasca cm. 31x34x33h 1 cesto cm. 28x29x15h - Filtro e coperchio vasca. Bacinella raccogliolio con filtro. Produzione patate: 15 kg/h <ul style="list-style-type: none"> Fryer threephase 18 lts - Bowl cm. 31x34x33h - 1 basket cm. 28x29x15h. Sieve and lid for pan. Drip tray with sieve. Production: 15 kg/h Friteuse dreiphasig lt. 18 - Becken cm. 31x34x33h - 1 Korb cm. 28x29x15h. Einlegesieb und Deckel für Becken. Fettauffangschale mit Sieb. Pommes frites: 15 kg/h Friteuse triphase lt. 18 - Cuve cm. 31x34x33h - 1 Panier cm. 28x29x15h. Filtre, couvercle pour cuve. Bac de récupération de l'huile avec filtre. Production de pommes frites: 15 kg/h Freidoras trifásico 18 lt. - Cuba cm. 31x34x33h - 1 cesta cm. 28x29x15h. Filtro y tapa para cuba. Bandeja recoge aceite con filtro. Prod. patatas: 15 Kg/h cm. 40x70,5x90h		$\frac{15,9 kW}{400V\sim 3N}$ 50/60 Hz	2.155,00 57 / 0,4
F2/8-74ET 08090432	FRIGGITRICE TRIFASE LT. 8+8 - 2 Vasche cm. 14,8x35x32,7h 2 cesti cm. 12x30x15h - Filtro e coperchio vasca. 2 bacinelle raccogliolio con filtro. Produzione patate: 12 kg/h <ul style="list-style-type: none"> Fryer threephase 8+8 lts - 2 Bowls cm. 14,8x35x32,7h - 2 baskets cm. 12x30x15h. Sieve and lid for pan. Drip tray with sieve. Production: 12 kg/h Friteuse dreiphasig lt. 8+8 - 2 Becken cm. 14,8x35x32,7h - 2 Korb cm. 12x30x15h. Einlegesieb und Deckel für Becken. Fettauffangschale mit Sieb. Pommes frites: 12 kg/h Friteuse triphase lt. 8+8 - 2 Cuve cm. 14,8x35x32,7h - 2 Panier cm. 12x30x15h. Filtre, couvercle pour cuve. Bac de récupération de l'huile avec filtre. Production de pommes frites: 12 kg/h Freidoras trifásico 8+8 lt. - 2Cuba cm. 14,8x35x32,7h - 2 cesta cm. 12x30x15h. Filtro y tapa para cuba. Bandeja recoge aceite con filtro. Prod. patatas: 12 Kg/h cm. 40x70,5x90h		$\frac{12 kW}{400V\sim 3N}$ 230V~3 50/60 Hz	2.760,00 59 / 0,4
F2/8-74G 08260452	FRIGGITRICE GAS LT. 8+8 - 2 vasche cm. 15x35x36h 2 cesti cm. 12x30x15h. Filtro e coperchio vasca. 2 bacinelle raccogliolio con filtro. Prod. patate: 12 kg/h <ul style="list-style-type: none"> Gas Fryer 8+8 lts - 2 pans cm. 15x35x36h 2 baskets cm. 12x30x15h. Sieve and lid for pan. 2 drip trays with sieves. Production: 12 kg/h Gas-Friteuse lt. 8+8 - 2 Becken cm. 15x35x36h 2 Körbe cm. 12x30x15h. Einlegesieb und Deckel für Becken. 2 Fettauffangschalen mit Sieb. Pommes frites: 12 kg/h Friteuse à gaz lt. 8+8 - 2 cuves cm. 15x35x36h 2 paniers cm. 12x30x15h. Filtre, couvercle pour cuve. 2 bacs de récupération de l'huile avec filtre. Production de pommes frites: 12 kg/h Freidoras a gas 8+8 lt. - 2 cubas cm. 15x35x36h 2 cestas cm. 12x30x15h. Filtro y tapa para cuba. 2 bandejas recoge aceite con filtro. Prod. patatas: 12 Kg/h cm. 40x70,5x90h		$\frac{10 kW}{8.600 kcal/h}$	3.250,00 59 / 0,4

SUPERLOTUS 70

MOD. COD.	DESCRIZIONE/DESCRIPTION/BEZEICHNUNG/DESCRIPTION/DESCRIPCIÓN DIMENSIONI/DIMENSIONS/ABMESSUNGEN/DIMENSIONS/DIMENSIONES	POTENZA/POWER/LEISTUNG/PUISSANCE/POTENCIA VOLTAGGIO/VOLTAGE/SPANNUNG/VOLTAGE/VOLTAJE	$\frac{\text{kW}}{\text{kcal/h}}$ $\frac{\text{kV}}{\text{Hz}}$	PREZZO/PRICE PREIS/PRIX/PRECIO €/KG / M ³
F13-74G 08260450	<p>FRIGGITRICE GAS LT. 13 - Vasca cm. 24x35x38h 1 cesto cm. 21x30x12h. Filtro e coperchio vasca. Bacinella raccogliolio con filtro. Prod. patate: 10 kg/h</p> <ul style="list-style-type: none"> Gas Fryer 13 lts - Bowl cm. 24x35x38h - 1 basket cm. 21x30x12h. Sieve and lid for pan. Drip tray with sieve. Production: 10 kg/h Gas-Friteuse lt. 13 - Becken cm. 24x35x38h - 1 Korb cm. 21x30x12h. Einlegesieb und Deckel für Becken. Fettauffangschale mit Sieb. Pommes frites: 10 kg/h Friteuse a gaz lt. 13 - Cuve cm. 24x35x38h - 1 Panier cm. 21x30x12h. Filtre, couvercle pour cuve. Bac de récupération de l'huile avec filtre. Production de pommes frites: 10 kg/h <p>Freidoras a gas 13 lt. - Cuba cm. 24x35x38h - 1 cesta cm. 21x30x12h. Filtro y tapa para cuba. Bandeja recoge aceite con filtro. Prod. patatas: 10 Kg/h cm. 40x70,5x90h</p>		$\frac{9,3 \text{ kW}}{8.000 \text{ kcal/h}}$	2.061,00 61 / 0,44
F18-74G 08260451	<p>FRIGGITRICE GAS LT. 18 - Vasca cm. 33x38x38h. 1 cesto cm. 30x33x12h. Filtro e coperchio vasca. Bacinella raccogliolio con filtro. Prod. patate: 15 kg/h</p> <ul style="list-style-type: none"> Gas Fryer 18 lts - Bowl cm. 33x38x38h - 1 basket cm. 30x33x12h. Sieve and lid for pan. Drip tray with sieve. Production: 15 kg/h Gas-Friteuse lt. 18 - Becken cm. 33x38x38h - 1 Korb cm. 30x33x12h. Einlegesieb und Deckel für Becken. Fettauffangschale mit Sieb. Pommes frites: 15 kg/h Friteuse a gaz lt. 18 - Cuve cm. 33x38x38h 1 Panier cm. 30x33x12h. Filtre, couvercle pour cuve. - Bac de récupération de l'huile avec filtre. Production de pommes frites: 15 kg/h <p>Freidoras a gas 18 lt. - Cuba cm. 33x38x38h - 1 cesta cm. 30x33x12h. Filtro y tapa para cuba. Bandeja recoge aceite con filtro. Prod. patatas: 15 Kg/h cm. 40x70,5x90h</p>		$\frac{13,5 \text{ kW}}{11.610 \text{ kcal/h}}$	2.296,00 66 / 0,44
F2/13-78ET 08090830	<p>FRIGGITRICE TRIFASE LT. 13+13 - 2 vasche cm. 24x35x38h 2 cesti cm. 21x30x12h 2 filtri e coperchi vasche. 2 bacinelle raccogliolio con filtro. Produzione patate: 20 kg/h</p> <ul style="list-style-type: none"> Fryer threephase 13+13 lts - 2 pans cm. 24x35x38h 2 baskets cm. 21x30x12h. 2 sieve and lids for pan. 2 drip trays with sieves. Production: 20 kg/h Friteuse dreiphasig lt. 13+13 - 2 Becken cm. 24x35x38h 2 Körbe cm. 21x30x12h. Einlegesieb und Deckel für Becken. 2 Fettauffangschalen mit Sieb. Pommes frites: 20 kg/h Friteuse triphase lt. 13+13 - 2 cuves cm. 24x35x38h 2 paniers cm. 21x30x12h. 2 filtres, couvercles pour cuve. 2 bacs de récupération de l'huile avec filtre. Production de pommes frites: 20 kg/h <p>Freidoras trifásico 13+13 lt. - 2 cubas cm. 24x35x38h 2 cestas cm. 21x30x12h. 2 filtros y tapas para cubas. 2 bandejas recoge aceite con filtro. Prod. patatas: 20 Kg/h cm. 80x70,5x90h</p>		$\frac{23,9 \text{ kW}}{400V\sim 3N}$ $\frac{50/60 \text{ Hz}}$	2.978,00 95 / 0,77
F2/18-78ET 08090831	<p>FRIGGITRICE TRIFASE LT. 18+18 - 2 vasche cm. 31x34x33h 2 cesti cm. 28x29x15h 2 filtri e coperchi vasche. 2 bacinelle raccogliolio con filtro. Produzione patate: 30 kg/h</p> <ul style="list-style-type: none"> Fryer threephase 18+18 lts - 2 pans cm. 31x34x33h 2 baskets cm. 28x29x15h. 2 sieve and lids for pan. 2 drip trays with sieves. Production: 30 kg/h Friteuse dreiphasig lt. 18+18 - 2 Becken cm. 31x34x33h 2 Körbe cm. 28x29x15h. Einlegesieb und Deckel für Becken. 2 Fettauffangschalen mit Sieb. Pommes frites: 30 kg/h Friteuse triphase lt. 18+18 - 2 cuves cm. 31x34x33h 2 paniers cm. 28x29x15h. 2 filtres, couvercles pour cuve. 2 bacs de récupération de l'huile avec filtre. Production de pommes frites: 30 kg/h <p>Freidoras trifásico 18+18 lt. - 2 cubas cm. 31x34x33h 2 cestas cm. 28x29x15h. 2 filtros y tapas para cuba. 2 bandejas recoge aceite con filtro. Prod. patatas: 30 Kg/h cm. 80x70,5x90h</p>		$\frac{31,8 \text{ kW}}{400V\sim 3N}$ $\frac{50/60 \text{ Hz}}$	3.313,00 97 / 0,77



SUPERLOTUS 70

MOD. COD.	DESCRIZIONE/DESCRIPTION/BEZEICHNUNG/DESCRIPTION/DESCRIPCIÓN DIMENSIONI/DIMENSIONS/ABMESSUNGEN/DIMENSIONS/DIMENSIONES	POTENZA/POWER/LEISTUNG/PUISSANCE/POTENCIA VOLTAGGIO/VOLTAGE/SPANNUNG/VOLTAGE/VOLTAJE	⚡ kW kcal/h	⚡ kw V~ Hz	PREZZO/PRICE € PREIS/PRIX/PRECIO € KG / M³
F2/13-78G 08260850	<p>FRIGGITRICE GAS LT. 13+13 - 2 vasche cm. 24x35x38h 2 cesti cm. 21x30x12h. 2 filtri e coperchi vasche. - 2 bacinelle raccogliolio con filtro. Prod. patate: 20 kg/h</p> <ul style="list-style-type: none"> Gas Fryer 13+13 lts - 2 pans cm. 24x35x38h 2 baskets cm. 21x30x12h. 2 sieve and lids for pan. 2 drip trays with sieves. Production: 20 kg/h Gas-Friteuse lt. 13+13 - 2 Becken cm. 24x35x38h 2 Körbe cm. 21x30x12h. Einlegesieb und Deckel für Becken. 2 Fettauffangschalen mit Sieb. Pommes frites: 20 kg/h Friteuse à gaz lt. 13+13 - 2 cuves cm. 24x35x38h 2 paniers cm. 21x30x12h. 2 filtres, couvercles pour cuve. 2 bacs de récupération de l'huile avec filtre. Production de pommes frites: 20 kg/h <p>Freidoras a gas 13+13 lt. - 2 cubas cm. 24x35x38h 2 cestas cm. 21x30x12h. 2 filtros y tapas para cubas. 2 bandejas recoge aceite con filtro. Prod. patatas: 20 Kg/h cm. 80x70,5x90h</p>		18,6 kW 16.000 kcal/h		3.656,00 102 / 0,77
F2/18-78G 08260851	<p>FRIGGITRICE GAS LT. 18+18 - 2 vasche cm. 33x38x38h - 2 cesti cm. 30x33x12h. 2 filtri e coperchi vasche. 2 bacinelle raccogliolio con filtro. Prod. patate: 30 kg/h</p> <ul style="list-style-type: none"> Gas Fryer 18+18 lts - 2 pans cm. 33x38x38h 2 baskets cm. 30x33x12h. 2 sieve and lids for pan. 2 drip trays with sieves. Production: 30 kg/h Gas-Friteuse lt. 18+18 - 2 Becken cm. 33x38x38h 2 Körbe cm. 30x33x12h. Einlegesieb und Deckel für Becken. 2 Fettauffangschalen mit Sieb. Pommes frites: 30 kg/h Friteuse à gaz lt. 18+18 - 2 cuves cm. 33x38x38h 2 paniers cm. 30x33x12h. 2 filtres, couvercles pour cuve. 2 bacs de récupération de l'huile avec filtre. Production de pommes frites: 30 kg/h <p>Freidoras a gas 18+18 lt. - 2 cubas cm. 33x38x38h 2 cestas cm. 30x33x12h. 2 filtros y tapas para cuba. 2 bandejas recoge aceite con filtro. Prod. patatas: 30 Kg/h cm. 80x70,5x90h</p>		27 kW 23.220 kcal/h		4.024,00 111 / 0,77
F45-78ET 08090835	<p>FRIGGITRICE TRIFASE LT. 45 - Vasca cm. 70x38x38h - 1 cesto cm. 65x33x17h Filtro e coperchio vasca. Bacinella raccogliolio con filtro. Produzione patate: 40 kg/h</p> <ul style="list-style-type: none"> Fryer threephase 45 lts - Bowl cm. 70x38x38h - 1 basket cm. 65x33x17h. Sieve and lid for pan. Drip tray with sieve. Production: 40 kg/h Friteuse dreiphasis lt. 45 - Becken cm. 70x38x38h - 1 Korb cm. 65x33x17h. Einlegesieb und Deckel für Becken. Fettauffangschale mit Sieb. Pommes frites: 40 kg/h Friteuse triphase lt. 45 - Cuve cm. 70x38x38h - 1 Panier cm. 65x33x17h. Filtre, couvercle pour cuve. Bac de récupération de l'huile avec filtre. Production de pommes frites: 40 kg/h <p>Freidoras trifásico 45 lt. - Cuba cm. 70x38x38h - 1 cesta cm. 65x33x17h. Filtro y tapa para cuba. Bandeja recoge aceite con filtro. Prod. patatas: 40 Kg/h cm. 80x70,5x90h</p>		40 kW 400V~3N 50/60 Hz		3.762,00 96 / 0,770
F45-78G 08260855	<p>FRIGGITRICE GAS LT. 45 - Vasca cm. 70x38x38h. 1 cesto cm. 65x33x17h. Filtro e coperchio vasca. Bacinella raccogliolio con filtro. Prod. patate: 40 kg/h</p> <ul style="list-style-type: none"> Gas Fryer 45 lts - Bowl cm. 70x38x38h - 1 basket cm. 65x33x17h. Sieve and lid for pan. Drip tray with sieve. Production: 40 kg/h Gas-Friteuse lt. 45 - Becken cm. 70x38x38h - 1 Korb cm. 65x33x17h. Einlegesieb und Deckel für Becken. Fettauffangschale mit Sieb. Pommes frites: 40 kg/h Friteuse a gaz lt. 45 - Cuve cm. 70x38x38h - 1 Panier cm. 65x33x17h. Filtre, couvercle pour cuve. Bac de récupération de l'huile avec filtre. Production de pommes frites: 40 kg/h <p>Freidoras a gas 45 lt. - Cuba cm. 70x38x38h - 1 cesta cm. 65x33x17h. Filtro y tapa para cuba. Bandeja recoge aceite con filtro. Prod. patatas: 40 Kg/h cm. 80x70,5x90h</p>		44 kW 37.840 kcal/h		4.552,00 110 / 0,950
			0,005 kW 230V~ 50 Hz		

SUPERLOTUS 70

MOD. / COD.	DESCRIZIONE / DESCRIPTION / BEZEICHNUNG / DESCRIPTION / DESCRIPCIÓN DIMENSIONI / DIMENSIONS / ABMESSUNGEN / DIMENSIONS / DIMENSIONES	POTENZA / POWER / LEISTUNG / PUISSANCE / POTENCIA VOLTAGGIO / VOLTAGE / SPANNUNG / VOLTAGE / VOLTAJE	$\frac{kW}{kcal/h}$ $\frac{V}{Hz}$	PREZZO / PRICE € PREIS / PRIX / PRECIO € KG / M ³
BR50-78ETF/F 08070830	BRASIERA ELETTRICA 50LT. RIB. MANUALE fondo ferro con coperchio • Electric 50lts. manual tilt. brat pan - iron bottom with lid • Elektrische Kippbratpfanne 50lt. - Man. Kippung boden heisen mit Deckel • Sauteuse électrique 50 l. basc. manuel - fond de fer avec couvercle • Sartén eléctrica 50lt. abat. manual - fondo de hierro con tapa cm. 80x70,5x90h		$\frac{10,5 kW}{400V\sim 3N}$ 50/60 Hz	4.569,00 133 / 0,77
BR50-78ETF/I 08070835	FONDO INOX /• Stainless steel bottom • Inoxboden /• Fond inox/• Fondo de acero inox.			4.825,00 133 / 0,77
BRM50-78ETF/F 08070831	BRASIERA ELETTRICA 50 LT. RIB. AUTOMATICO fondo ferro con coperchio • Electric 50 lts. automatic tilt. brat pan - iron bottom with lid • Elektrische Bratpfanne 50 Lt. - Autom. Kippung boden heisen mit Deckel • Sauteuse électrique 50 l. basc. automatique - fond de fer avec couvercle • Sartén eléctrica 50 lt. abat. automática - fondo de hierro con tapa cm. 80x70,5x90h		$\frac{10,5 kW}{400V\sim 3N}$ 50 Hz	5.805,00 135 / 0,77
BRM50-78ETF/I 08070836	Fondo inox • Stainless steel bottom /• Inoxboden /• Fond inox/• Fondo de acero inox.			6.060,00 135 / 0,77
BR50-78GF/F 08240850	BRASIERA GAS 50 LT. RIB. MANUALE fondo ferro con coperchio • Gas 50 lts. manual tilt. brat pan - iron bottom with lid • Gas-Kippbratpfanne 50 lt. - Man. Kippung - boden heisen mit Deckel • Sauteuse à gaz 50 l. basc. manuel - fond de fer avec couvercle • Sartén a gas 50 lt. abat. manual - fondo de hierro con tapa cm. 80x70,5x90h		$\frac{12 kW}{10.320 kcal/h}$	4.988,00 133 / 0,77
BR50-78GF/I 08240855	Fondo inox • Stainless steel bottom /• Inoxboden /• Fond inox/• Fondo de acero inox.			5.252,00 135 / 0,77
BRM50-78GF/F 08240851	BRASIERA GAS 50 LT. RIB. AUTOMATICO fondo ferro con coperchio • Gas 50 lts. automatic tilt. Brat pan - iron bottom with lid • Gas-Bratpfanne 50 lt. - Autom. Kippung - boden heisen mit Deckel • Sauteuse à gaz 50 l. basc. automatique - fond de fer avec couvercle • Sartén a gas 50 lt. abat. automática - fondo de hierro con tapa cm. 80x70,5x90h		$\frac{12 kW}{10.320 kcal/h}$ $\frac{0,1 KW}{230V\sim}$ 50 Hz	6.024,00 139 / 0,77
BRM50-78GF/I 08240856	Fondo inox • Stainless steel bottom /• Inoxboden /• Fond inox/• Fondo de acero inox.			6.291,00 139 / 0,77
BRF-74ET 08070433	BRASIERA FISSA MULTIFUNZIONALE ELETTRICA Vasca cm. 30x51x10h • Electric multi-function fixed braising pan - Bowl cm. 30x51x10h • Elektrische Multifunktionsbratpfanne Fest Becken cm. 30x51x10h • Sauteuse fixe multifonction électrique - Cuve cm. 30x51x10h • Sarten fija multifunción eléctrica - Cuba cm. 30x51x10h cm. 40x70,5x90h		$\frac{4 kW}{400V\sim 2N}$ 230V~3 50/60 Hz	3.128,00 79 / 0,4
BRF-78ET 08070833	BRASIERA FISSA MULTIFUNZIONALE ELETTRICA Vasca cm. 70x51x10h • Electric multi-function fixed braising pan - Bowl cm. 70x51x10h • Elektrische Multifunktionsbratpfanne Fest Becken cm. 70x51x10h • Sauteuse fixe multifonction électrique - Cuve cm. 70x51x10h • Sarten fija multifunción eléctrica - Cuba cm. 70x51x10h cm. 80x70,5x90h		$\frac{8 kW}{400V\sim 3N}$ 50/60 Hz	4.732,00 126 / 0,77
BRF-74G 08240453	BRASIERA FISSA MULTIFUNZIONALE GAS Vasca 30x51x10h • Gas multi-function fixed braising pan Bowl 30x51x10h • Gas-Multifunktionsbratpfanne Fest Becken 30x51 x10h • Sauteuse fixe multifonction à gaz - Cuve 30x51x10h • Sarten fija multifunción a gas - Cuba 30x51x10h cm. 40x70,5x90h		$\frac{6,95 kW}{5.970 kcal/h}$	3.344,00 79 / 0,4
BRF-78G 08240853	BRASIERA FISSA MULTIFUNZIONALE GAS Vasca 70x51x10h • Gas multi-function fixed braising pan Bowl 70x51x10h • Gas-Multifunktionsbratpfanne Fest Becken 70x51 x10h • Sauteuse fixe multifonction à gaz - Cuve 70x51x10h • Sarten fija multifunción a gas - Cuba 70x51x10h cm. 80x70,5x90h		$\frac{13,9 kW}{11.940 kcal/h}$	5.148,00 129 / 0,77



SUPERLOTUS 70

MOD. COD.	DESCRIZIONE/DESCRIPTION/BEZEICHNUNG/DESCRIPTION/DESCRIPCIÓN DIMENSIONI/DIMENSIONS/ABMESSUNGEN/DIMENSIONS/DIMENSIONES	PREZZO/PRICE PREIS/PRIX/PRECIO € KG / M ³
PL-72 08010200	PIANO LAVORO SU MOBILE <ul style="list-style-type: none"> • Worktop on cabinet • Arbeitsplatte mit Unterbau • Plan de travail sur armoire • Sobre de trabajo sobre mueble cm. 20x70,5x90h	583,00 30 / 0,4
PLS-74 08010401	PIANO LAVORO SU MOBILE A GIORNO <ul style="list-style-type: none"> • Worktop on open cabinet • Arbeitsplatte mit offenem Unterbau • Plan de travail sur armoire ouvert • Sobre de trabajo sobre mueble abierto cm. 40x70,5x90h	725,00 45 / 0,4
PLS-76 08010601	cm. 60x70,5x90h	1.095,00 56 / 0,65
PLS-78 08010801	cm. 80x70,5x90h	1.225,00 67 / 0,77
PL-74 08010400	PIANO LAVORO SU MOBILE A GIORNO Cassetto con 1 bacinella GN 1/1 15h plastica <ul style="list-style-type: none"> • Worktop on open cabinet • Drawer with 1 plastic container GN 1/1 15h • Arbeitsplatte mit offenem Unterbau • Schublade mit 1 GN 1/1 15h Kunststoffbehälter • Plan de travail sur armoire ouvert • Tiroir avec bac en plastique GN 1/1 15h. • Sobre de trabajo sobre mueble abierto Cajón con 1 contenedor GN 1/1 15h plástico cm. 40x70,5x90h	921,00 40 / 0,4
PL-76 08010600	PIANO LAVORO SU MOBILE A GIORNO Cassetto - 1 bacinella inox cm 49x50x15h <ul style="list-style-type: none"> • Worktop on open cabinet • Drawer - 1 inoxcontainer cm 49x50x15h • Arbeitsplatte mit offenem Unterbau • Schublade - 1 Chromnickelstahlbehälter cm 49x50x15h • Plan de travail sur armoire ouvert • Tiroir - Bac en inox cm 49x50x15h • Sobre de trabajo sobre mueble abierto Cajón - 1 contenedor cm 49x50x15h de acero inox cm. 60x70,5x90h	1.313,00 47 / 0,65
PL-78 08010800	PIANO LAVORO SU MOBILE A GIORNO Cassetto con 2 bacinelle GN 1/1 15h plastica <ul style="list-style-type: none"> • Worktop on open cabinet • Drawer with 2 plastic containers GN 1/1 15h • Arbeitsplatte mit offenem Unterbau • Schublade mit 2 GN 1/1 15h Kunststoffbehälter • Plan de travail sur armoire ouvert • Tiroir avec 2 bacs en plastique GN 1/1 15h • Sobre de trabajo sobre mueble abierto Cajón con 2 contenedores GN 1/1 15h plástico cm. 80x70,5x90h	1.465,00 55 / 0,77
LA-74 08020400	LAVELLO SU MOBILE A GIORNO Rubinetto a leva - Vasca cm. 30x35x15h <ul style="list-style-type: none"> • Sink unit on open cabinet - Lever type tap. • Bowl cm. 30x35x15h • Spülbecken Einhebel-Mischbatterie mit offenem Unterbau • Becken cm. 30x35x15h • Bac-évier sur armoire ouvert avec robinetterie • Bac cm. 30x35x15h • Fregadero sobre mueble abierto - Grifo a palanca Pileta cm. 30x35x15h cm. 40x70,5x90h	1.173,00 45 / 0,4

SUPERLOTUS 70

MOD. / COD.	DESCRIZIONE / DESCRIPTION / BEZEICHNUNG / DESCRIPTION / DESCRIPCIÓN DIMENSIONI / DIMENSIONS / ABMESSUNGEN / DIMENSIONS / DIMENSIONES	PREZZO / PRICE € PREIS / PRIX / PRECIO € KG / M ²
P-73/93-DX 08430300	PORTA 300 DESTRA • Right door 300 / • Rechte tür 300 • Porte droite 300 / • Puerta derecha 300 cm. 29,5x2,5x47,5h	159,00 3 / 0,005
P-74/94-DX 08430400	PORTA 400 DESTRA • Right door 400 / • Rechte tür 400 • Porte droite 400 / • Puerta derecha 400 cm. 39,5x2,5x47,5h	165,00 3,5 / 0,006
P-73/93-SX 08430301	PORTA 300 SINISTRA • Left door 300 / • Linke tür 300 • Porte gauche 300 / • Puerta iziquierda 300 cm. 29,5x2,5x47,5h	159,00 3 / 0,005
P-74/94-SX 08430401	PORTA 400 SINISTRA • Left door 400 / • Linke tür 400 • Porte gauche 400 / • Puerta iziquierda 400 cm. 39,5x2,5x47,5h	165,00 3,5 / 0,006

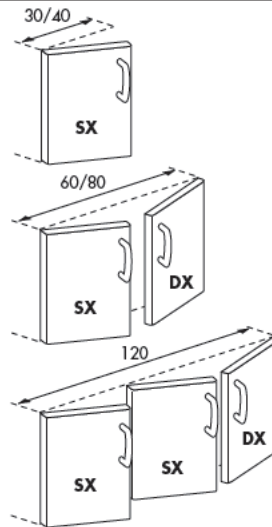

C-74/94 08440420	CASSETTIERA 400 - N. 2 cassetti con 2 bacinelle GN 1/1 15h in plastica, guide telescopiche • Drawer set 400 - N. 2 drawers with 2 GN 1/1 15h plastic containers, telescopic guides • Schubladen - N. 2 Schubladen mit 2 GN 1/1 15h Kunststoffbehältern, Telescopeinführungen • Tiroirs pour meuble de 400 - N. 2 tiroirs avec 2 bacs en plastique GN 1/1 15h, guides télescopiques • Cajonera 400 - N. 2 cajones con 2 contenedores GN 1/1 15h de plástico, guías telescópicas cm. 39,5x59x47,5h	Solo su PL • Only for PL • Nur für PL • Seulement pour PL • Sólo para PL	635,00 18 / 0,11
C-76/96 08440620	CASSETTIERA 600 - N. 2 cassetti con 2 bacinelle inox, guide telescopiche • Drawer set 600 N. 2 drawers with 2 inoxcontainers, telescopic guides • Schubladen 600 - N. 2 Schubladen mit 2 Chromnickelstahlbehältern, Telescopeinführungen • Tiroirs pour meuble de 600 N. 2 tiroirs avec 2 bacs inox, guides télescopiques • Cajonera 600 - N. 2 cajones con 2 contenedores de acero inox, guías telescópicas cm. 59,5x59x47,5h	Solo su PL • Only for PL • Nur für PL • Seulement pour PL • Sólo para PL	879,00 22 / 0,18
C-78/98 08440820	CASSETTIERA 800 - N. 2 cassetti con 4 bacinelle GN 1/1 15h in plastica, guide telescopiche • Drawer set 800 - N. 2 drawers with 4 GN 1/1 15h plastic containers, telescopic guides • Schubladen 800 - N. 2 Schubladen mit 4 GN 1/1 15h Kunststoffbehältern, Telescopeinführungen • Tiroirs pour meuble de 800 - N. 2 tiroirs avec 4 bacs en plastique GN 1/1 15h, guides télescopiques • Cajonera 800 - N. 2 cajones con 4 contenedores GN 1/1 15h de plástico, guías telescópicas cm. 79,5x59x47,5h	Solo su PL • Only for PL • Nur für PL • Seulement pour PL • Sólo para PL	896,00 26 / 0,22

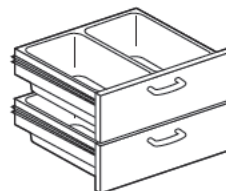
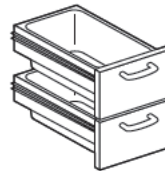

SIA-7/9 08480000	STAFFA INFERIORE UNIONE APPARECCHI • Lower bracket to join two item		48,00 2 / 0,001
----------------------------	---	--	---------------------------

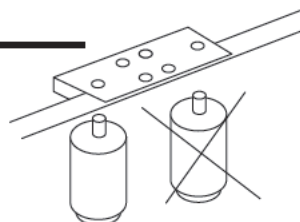



Si può eliminare
You can eliminate

SR-100 50900001	SET 4 RUOTE Ø 100x30, 2 con freno • Set of 4 wheels Ø 100x30, 2 with brake • 4 Rollen Satz Ø 100x30, 2 davon mit Feststellbremse • Kit 4 roues Ø 100x30, 2 avec frein • Equipo 4 ruedas Ø 100x30, 2 con frenos cm. 12,7h		288,00 1 / 0,01
---------------------------	--	--	---------------------------

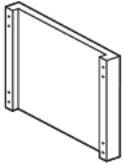
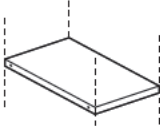
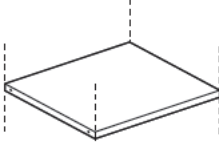
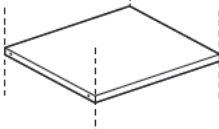
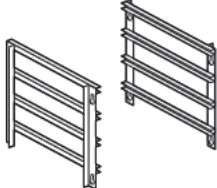
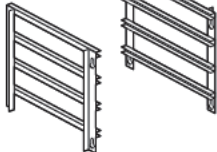
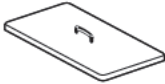
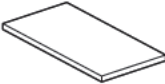

SUPERLOTUS 70

MOD. COD.	DESCRIZIONE/DESCRIPTION/BEZEICHNUNG/DESCRIPTION/DESCRIPCIÓN DIMENSIONI/DIMENSIONS/ABMESSUNGEN/DIMENSIONS/DIMENSIONES		PREZZO/PRICE PREIS/PRIX/PRECIO € KG / M ³
D-7 08470000	DIVISORIO • Spacer • Trennwand • Separation • Divisorio cm. 5x59x45h		129,00 2,5 / 0,015
R-74 08450400	RIPIANO 400 • Shelf 400 / • Zwischenboden 400 • Etagère 400 / • Estante 400		102,00 2 / 0,006
R-76 08450600	RIPIANO 600 • Shelf 600 / • Zwischenboden 600 • Etagère 600 / • Estante 600		114,00 3 / 0,01 Solo su PL • Only for PL • Nur für PL • Seulement pour PL • Sólo para PL
R-78 08450800	RIPIANO 800 • Shelf 800 / • Zwischenboden 800 • Etagère 800 / • Estante 800		129,00 3,5 / 0,01
PT-74/94 08460002	PORTATEGLIE VANO 400/600 (GN-1/1) 4 ripiani int. 7 cm. • Frame for oven plates 400/600 (GN-1/1). 4 shelves, wheel-base 7 cm. • Aufhängeschienen für Backbleche 400/600 (GN-1/1). 4 Etagen, Abstand 7 cm. • Kit porte-plaques 400/600 (GN-1/1). 4 étagères; 7 cm int. • Portacazuelas 400/600 (GN-1/1). 4 estantes int. 7 cm		344,00 2,5 / 0,01
PT-78/98 08460012	PORTATEGLIE VANO 800 (GN-2/1) 4 ripiani int. 7 cm. • Frame for plates 800 (GN-2/1) 4 Etagen, Abstand 7 cm. • Aufhängeschienen für bleche 800 (GN-2/1) N. 4 Etagen, Abstand 7 cm. • Kit porte-plaques 800 (GN-2/1) - N. 4 étagères; 7 cm. • Portacazuelas 800 (GN-2/1) - N. 4 estantes, int. 7 cm.		459,00 4 / 0,02 SOLO PL E VANO CUCINE • Only on cooking area, PL • Nur im der neutralen schrankelement, PL • Seulement sur element neutre du four, P • Solo en zona cocina, PL
08550400	COPERCHIO BRF-74 • Lid BRF-74 / • Deckel BRF-74 • Couvercle BRF-74 / • Tapa BRF-74 cm. 32x53x5h		114,00 2 / 0,02
08550800	COPERCHIO BRF-78 • Lid BRF-78 / • Deckel BRF-78 • Couvercle BRF-78 / • Tapa BRF-78 cm. 72x53x5h		152,00 4 / 0,04
TG-4 07580400	TAGLIERE PLASTICA • Plastic chopping-board • Schneidebrett • Plan de découpe • Picador de plástico cm. 39x58x2,5h		127,00 6 / 0,015
TG-6 07580600	cm. 59x58x2,5h		188,00 9 / 0,02
TG-8 07580800	cm. 79x58x2,5h		243,00 11 / 0,025
532005901	GRIGLIA 1 FUOCO • 1 flame grill / • Rost 1 flamme • Frille 1 feu / • Parilla 1 quemador		87,00 3 / 0,001

SUPERLOTUS 70

MOD. COD.	DESCRIZIONE/DESCRIPTION/BEZEICHNUNG/DESCRIPTION/DESCRIPCIÓN DIMENSIONI/DIMENSIONS/ABMESSUNGEN/DIMENSIONS/DIMENSIONES	POTENZA/POWER/LEISTUNG/PUISSANCE/POTENCIA VOLTAGGIO/VOLTAGE/SPANNUNG/VOLTAGE/VOLTAJE	⚡ kW kcal/h	⚡ kW V~ Hz	PREZZO/PRICE PREIS/PRIX/PRECIO € KG / M ³
544439900	ANELLO PER WOK - solo per griglie in ghisa • Wok ring - only for cast iron grills • Wok Aufsatzring - nur für Roste aus Gusseisen • Anneau Wok - seulement pour grilles en fonte • Anillo Wok - solo para parrilas de hierro colado ø 22,5 cm. x3,5h				127,00 2 / 0,006
PLF 07590401	PIASTRA LISCIA per GRIGLIA IN GHISA • Smooth griddle plate for cast iron grid • Fortkochplatte glatt für Gusseisen Rost • Plaque lisse pour la grille en fonte • Plancha lisa para rejilla de hierro fundido cm. 35x27				152,00 9 / 0,005
PLF/2 07590421	PIASTRA LISCIA 2 FUOCHI per GRIGLIA IN GHISA • Smooth griddle plate 2 burners for cast iron grid • Fortkochplatte glatt 2 Kochstellen für Gusseisen Rost • Plaque lisse 2 feux pour la grille en fonte • Plancha lisa 2 quemadores para rejilla de hierro fundido cm. 35x57				302,00 18 / 0,01
PRF 07590403	PIASTRA RIGATA per GRIGLIA IN GHISA • Grooved griddle plate for cast iron grid • Fortkochplatte gerillt für Gusseisen Rost • Plaque nervurée pour la grille en fonte • Plancha estriada para rejilla de hierro fundido cm. 35x27				206,00 9 / 0,005
PRF/2 07590423	PIASTRA RIGATA 2 FUOCHI per GRIGLIA IN GHISA • Grooved griddle plate 2 burners for cast iron grid • Fortkochplatte gerillt 2 Kochstellen für Gusseisen Rost • Plaque nervurée 2 feux pour la grille en fonte • Plancha estriada 2 quemadores para rejilla de hierro fundido cm. 35x57				336,00 18 / 0,01
PLFT/7 08590451	PIASTRA LISCIA per GRIGLIA IN TONDINO • Smooth griddle plate for grid rod • Fortkochplatte glatt für Gitterstab • Plaque lisse pour tige grille • Plancha lisa por red de varilla cm. 35x27				152,00 9 / 0,005
PLFT/72 08590471	PIASTRA LISCIA 2 FUOCHI per GRIGLIA IN TONDINO • Smooth griddle plate 2 burners for grid rod • Fortkochplatte glatt 2 Kochstellen für Gitterstab • Plaque lisse 2 feux pour tige grille • Plancha lisa 2 quemadores por red de varilla cm. 35x57				302,00 18 / 0,010
PRFT/7 08590453	PIASTRA RIGATA per GRIGLIA IN TONDINO • Grooved griddle plate for grid rod • Fortkochplatte gerillt für Gitterstab • Plaque nervurée pour tige grille • Plancha estriada por red de varilla cm. 35x27				206,00 9 / 0,005
PRFT/72 08590473	PIASTRA RIGATA 2 FUOCHI per GRIGLIA IN TONDINO • Grooved griddle plate 2 burners for grid rod • Fortkochplatte gerillt 2 Kochstellen für Gitterstab • Plaque nervurée 2 feux pour tige grille • Plancha estriada 2 quemadores por red de varilla cm. 35x57				336,00 18 / 0,010
533009200	GRIGLIA DI RIDUZIONE • Reduction / • Reduzierstern • Grille de réduction / • Rejilla de reducción cm. 25x25				30,00 0,2 / 0,001
RV 08660410	RISCALDANTE VANO CUCINA • Heater for cooker cabinet / • Heizer für Herden-Schränkelement • Réchauffeur pour armoire du fourneau • Calefacción para armario neutro de la cocina cm. 32x48,5x8h			⚡ 0,75 kW 230V~ 50/60 Hz	731,00 8 / 0,03

SUPERLOTUS 70

MOD. COD.	DESCRIZIONE/DESCRIPTION/BEZEICHNUNG/DESCRIPTION/DESCRIPCIÓN DIMENSIONI/DIMENSIONS/ABMESSUNGEN/DIMENSIONS/DIMENSIONES	PREZZO/PRICE PREIS/PRIX/PRECIO € KG / M ³
08570401	GRIGLIA TONDINO per CW (SERIE 70) • Grid for CW (70 line) / • Gitter für CW (70. Serie) • Grille ronde pour CW (serie 70) / • Rejilla para CW (serie 70) cm. 36x51	340,00 11 / 0,015
08570402	GRIGLIA TEGOLO V per CW (SERIE 70) • Grid V for CW (70 line) / • Gitter V für CW (70. Serie) • Grille V pour CW (serie 70) / • Rejilla V para CW (serie 70) cm. 36x51	340,00 11 / 0,015
544023800	RASCHIETTO PER PIASTRA RIGATA • Scraper for gooved plate / • Schaber für gerillte Kochplatte • Racloir pour plaque nervurée / • Rasqueta para placa ranurada	50,00
531040800	RASCHIETTO PER PIASTRA LISCIA CROMATA • Scraper for smooth chromed plate / • Schaber für glatte verchromte Platte • Racloir pour plaque lisse au chrome / • Rasqueta para placa lisa cromada	47,00
531040900	KIT 10 LAME PER RASCHIETTO • 10 blades kit for scraper / • Kit 10 Klingen für Schaber • Kit de 10 lames pour racloir / • Kit de 10 cuchillas para rasqueta	33,00
T-FT 09580060	TAPPO PER FRY-TOP • Stopper for Fry-top / • Stopfen griddleplatte • Bouchon pour Plaque / • Tapón Fry-top cm. 10x2x5h	201,00
PFT-64/74 06620400	KIT PROTEZIONE FRONTALE PIANO FRY-TOP • KIT front protection plan fry-top / • Schutz-kit vorne Plan griddleplatte • KIT protection avant plan plaque / • KIT de protección frontal plan de fry-top cm. 38x8x6h	103,00
PFT-66/76 06620600	cm. 58x8x6h	139,00
PFT-68/78 06620800	cm. 78x8x6h	174,00
PFT-712 06621200	cm. 118x8x6h	197,00
531013200	CESTINO 1/2 per F13-G/E • Basket 1/2 for F13-G/E • Korb 1/2 zur Friteuse F13-G/E • Panier 1/2 pour F13-G/E • Cesta 1/2 para F13-G/E cm. 10x30x12h	47,00 0,7 / 0,016
531013500	CESTINO 1/2 per F18-70G • Basket 1/2 for F18-70G • Korb 1/2 zur Friteuse F18-70G • Panier 1/2 pour F18-70G • Cesta 1/2 para F18-70G cm. 14x33x12h	62,00 0,8 / 0,022
531041600	CESTINO 1/2 per F18-E & F16P-G • Basket 1/2 for F18-E & F16P-G • Korb 1/2 zur Friteuse F18-E & F16P-G • Panier 1/2 pour F18-E & F16P-G • Cesta 1/2 para F18-E & F16P-G cm. 13,5x29x15h	62,00 0,8 / 0,015
531033300	CESTO 1/1 F45 • Basket 1/1 F45 • Korb 1/1 F45 • Panier 1/1 F45 • Cesta 1/1 F45 cm. 65x33x17h	164,00 3 / 0,11
531041300	CESTO 1/2 F45 • Basket 1/2 F45 • Korb 1/2 F45 • Panier 1/2 F45 • Cesta 1/2 F45 cm. 28x29x15h	68,00 1,5 / 0,05
531047800	CESTO 1/3 F45 • Basket 1/3 F45 • Korb 1/3 F45 • Panier 1/3 F45 • Cesta 1/3 F45 cm. 21,5x33x1,5h	80,00 1,3 / 0,05

SUPERLOTUS 70

MOD. COD.	DESCRIZIONE/DESCRIPTION/BEZEICHNUNG/DESCRIPTION/DESCRIPCIÓN DIMENSIONI/DIMENSIONS/ABMESSUNGEN/DIMENSIONES/DIMENSIONES	PREZZO/PRICE PREIS/PRIX/PRECIO € KG / M ³
40280800	<p>SCIVOLO inox 80 / F45</p> <ul style="list-style-type: none"> • Stainless steel slide 80 / F45 • Rutsche aus rostfreiem Stahl 80 / F45 • Goulotte en acier inox 80 / F45 • Deslizador inox 80 / F45 <p>cm. 38x75x27h</p>	<p>127,00 5 / 0,08</p>
531070200	<p>CESTO PER SOLLEVATORE CESTI 1/1S PER CP-74/78 - 2/3S PER CP-94/98 & CPB-98</p> <ul style="list-style-type: none"> • Basket for basket elevator 1/1S for CP-74/78 - 2/3S for CP-94/98 & CPB-98 • Korb für heben Korbe 1/1S für CP-74/78 - 2/3S für CP-94/98 & CPB-98 • Panier pour soulever des paniers 1/1S pour CP-74/78 - 2/3S pour CP-94/98 & CPB-98 • Cesta para levante cestas 1/1S para CP-74/78 - 2/3S para CP-94/98 & CPB-98 <p>cm. 28x32x21,5h</p>	<p>143,00 2 / 0,04</p>
531032400	<p>CESTO 1/2 PER CP-74/78</p> <ul style="list-style-type: none"> • Basket 1/2 for CP-74/78 / • Korb 1/2 für CP-74/78 • Panier 1/2 pour CP-74/78 / • Cesta 1/2 para CP-74/78 <p>cm. 14x32x20h</p>	<p>95,00 1,5 / 0,020</p>
531047900	<p>CESTO PER SOLLEVATORE CESTI 1/2S PER CP-74/78 - 1/3S PER CP-94/98 & CPB-98</p> <ul style="list-style-type: none"> • Basket for basket elevator 1/2S for CP-74/78 - 1/3S for CP-94/98 & CPB-98 • Korb für heben Korbe 1/2S für CP-74/78 - 1/3S für CP-94/98 & CPB-98 • Panier avec soulever des paniers 1/2S pour CP-74/78 - 1/3S pour CP-94/98 & CPB-98 • Cesta para levante cestas 1/2S para CP-74/78 - 1/3S para CP-94/98 & CPB-98 <p>cm. 28x16x21,5h</p>	<p>102,00 1,5 / 0,02</p>
531048000	<p>CESTO PER SOLLEVATORE CESTI 1/4S PER CP-74/78 - 1/6S PER CP-94/98 & CPB-98</p> <ul style="list-style-type: none"> • Basket for basket elevator 1/4S for CP-74/78 - 1/6S for CP-94/98 & CPB-98 • Korb für heben Korbe 1/4S für CP-74/78 - 1/6S für CP-94/98 & CPB-98 • Panier avec soulever des paniers 1/4S pour CP-74/78 - 1/6S pour CP-94/98 & CPB-98 • Cesta para levante cestas 1/4S para CP-74/78 - 1/6S para CP-94/98 & CPB-98 <p>cm. 13,5x16x21,5h</p>	<p>79,00 1 / 0,02</p>
531032600	<p>CESTO 1/6 PER CP-74/78</p> <ul style="list-style-type: none"> • Basket 1/6 for CP-74/78 / • Korb 1/6 für CP-74/78 • Panier 1/6 pour CP-74/78 / • Cesta 1/6 para CP-74/78 <p>cm. 14x10x20h</p>	<p>67,00 0,7 / 0,005</p>
531053900	<p>CESTO 1/1 PER CP-66/76</p> <ul style="list-style-type: none"> • Basket 1/1 for CP-66/76 / • Korb 1/1 für CP-66/76 • Panier 1/1 pour CP-66/76 / • Cesta 1/1 para CP-66/76 <p>cm. 49x29x20h</p>	<p>149,00 3,5 / 0,043</p>
531017900	<p>CESTO 1/3 PER CP-66/76</p> <ul style="list-style-type: none"> • Basket 1/3 for CP-66/76 / • Korb 1/3 für CP-66/76 • Panier 1/3 pour CP-66/76 / • Cesta 1/3 para CP-66/76 <p>cm. 16x29x20h</p>	<p>108,00 1,5 / 0,021</p>
531064300	<p>CESTO 1/4 PER CP-66/76 & CPM-6G</p> <ul style="list-style-type: none"> • Basket 1/4 for CP-66/76 & CPM-6G • Korb 1/4 für CP-66/76 & CPM-6G • Panier 1/4 pour CP-66/76 & CPM-6G • Cesta 1/4 para CP-66/76 & CPM-6G <p>cm. 11,5x29x20h</p>	<p>96,00 1,2 / 0,015</p>

SUPERLOTUS 70

MOD. COD.	DESCRIZIONE/DESCRIPTION/BEZEICHNUNG/DESCRIPTION/DESCRIPCIÓN DIMENSIONI/DIMENSIONS/ABMESSUNGEN/DIMENSIONS/DIMENSIONES	PREZZO/PRICE € PREIS/FRX/PRECIO € KG / M ³
531071100	CESTO CON GANCIO 1/2 PER CP-74/78 • Basket with hook 1/2 for CP-74/78 • Korb mit Haken 1/2 für CP-74/78 • Panier avec crochet 1/2 pour CP-74/78 • Cesta con gancho 1/2 para CP-74/78 cm. 14,5x29x20h	132,00 1,5 / 0,02
531071200	CESTO CON GANCIO 1/3 PER CP-66/76 • Basket with hook 1/3 for CP-66/76 • Korb mit Haken 1/3 für CP-66/76 • Panier avec crochet 1/3 pour CP-66/76 • Cesta con gancho 1/3 para CP-66/76 cm. 15x26x20h	118,00 1,5 / 0,021
531018700	CESTO CON GANCIO 1/4 PER CP-66/76 & CPM-6G • Basket with hook 1/4 for CP-66/76 & CPM-6G • Korb mit Haken 1/4 für CP-66/76 & CPM-6G • Panier avec crochet 1/4 pour CP-66/76 & CPM-6G • Cesta con gancho 1/4 para CP-66/76 & CPM-6G cm. 11x26x20h	97,00 1,2 / 0,015
531069300	GRIGLIA SUPPORTO CESTI CON GANCIO PER CP-74/78 • Support for baskets with hook for CP-74/78 • Unterstützung für Körbe mit Haken für CP-74/78 • Soutien pour les paniers avec crochet pour CP-74/78 • Soporte para cestas con gancho para CP-74/78 cm. 30x33x41h	113,00 3,5 / 0,04
531069400	GRIGLIA SUPPORTO CESTI CON GANCIO PER CP-66/76 • Support for baskets with hook for CP-66/76 • Unterstützung für Körbe mit Haken für CP-66/76 • Soutien pour les paniers avec crochet pour CP-66/76 • Soporte para cestas con gancho para CP-66/76 cm. 50x29x41h	147,00 4 / 0,06
TPA-7 08560001	TESTATA CHIUSURA PIANO • Head end filler strip • Abschluss-Element • Element de jonction top • Chapa de cierre para top	58,00 1 / 0,001
	TESTATA 1 LATO SERIE 70 • Head 1 side S70 • Abschluss element 1 seite S70 • Element de jonction 1 coté S70 • Embellecedor 1 lado S70	210,00 8 / 0,01
	TESTATA 2 LATI SERIE 70 • Head 2 sides S70 • Abschluss element seiten S70 • Element de jonction 2 cotés S70 • Embellecedor 2 lados S70	420,00 16 / 0,02

SUPERLOTUS 70

MOD. COD.	DESCRIZIONE/DESCRIPTION/BEZEICHNUNG/DESCRIPTION/DESCRIPCIÓN DIMENSIONI/DIMENSIONS/ABMESSUNGEN/DIMENSIONS/DIMENSIONES	PREZZO/PRICE PREIS/PRIZ/PREÇO € KG / M³
	<p>COPPIA TRAVERSE SUPPORTO PONTE • 70/90 • • Support for bridge type system / • Bruckengestell • Support en pont</p>	
TSP-4 18400400	cm. 40 - cm. 40x6x6	174,00
TSP-6 18400600	cm. 60 - cm. 60x6x6	196,00
TSP-8 18400800	cm. 80 - cm. 80x6x6	219,00
TSP-10 18401000	cm. 100 - cm. 100x6x6	244,00
TSP-12 18401200	cm. 120 - cm. 120x6x6	266,00
TSP-14 18401400	cm. 140 - cm. 140x6x6	289,00
TSP-16 18401600	cm. 160 - cm. 160x6x6	307,00
TSP-18 18401800	cm. 180 - cm. 180x6x6	335,00
TSP-20 18402000	cm. 200 - cm. 200x6x6	353,00
08610800	<p>MITRA 800 • Chimney jack 800 / • Lüftungsaufsatz 800 • Mitre 800 / • Caperuza 800 cm. 80x7x80</p>	474,00 14 / 0,05
08611200	<p>MITRA 1200 • Chimney jack 1200 / • Lüftungsaufsatz 1200 • Mitre 1200 / • Caperuza 1200 cm. 120x7x80</p>	633,00 21 / 008
08610801	<p>CAMINO ANTIVENTO 800 • Draught diverter 800 / • Strömungssicherung 800 • Cheminee anti-vent 800 / • Chimenea antiviento 800 cm. 80x18x100</p>	670,00 17,5 / 0,15
08611201	<p>CAMINO ANTIVENTO 1200 • Draught diverter 1200 / • Strömungssicherung 1200 • Cheminee anti-vent 1200 • Chimenea antiviento 1200 cm. 120x18x100</p>	883,00 25,5 / 0,23

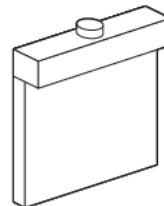
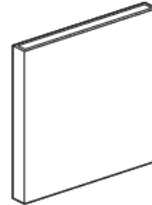
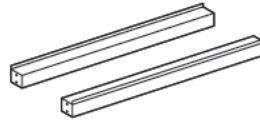

SUPERLOTUS 70MOD.
COD.DESCRIZIONE/DESCRIPTION/BEZEICHNUNG/DESCRIPTION/DESCRIPCIÓN
DIMENSIONI/DIMENSIONS/ABMESSUNGEN/DIMENSIONS/DIMENSIONES€
KG / M³**MENSOLA ANTERIORE**

- Earlier shelf / • Frühere Regal
- Plus tôt plateau / • **A principios de la plataforma**

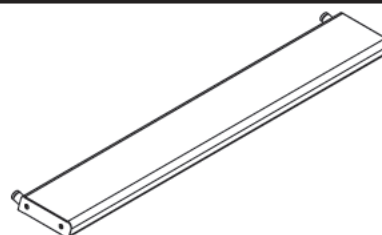

08570103	cm. 30x21x5h	331,00
08570104	cm. 40x21x5h	339,00
08570105	cm. 50x21x5h	349,00
08570106	cm. 60x21x5h	359,00
08570107	cm. 70x21x5h	368,00
08570108	cm. 80x21x5h	376,00
08570109	cm. 90x21x5h	386,00
08570110	cm. 100x21x5h	396,00
08570111	cm. 110x21x5h	407,00
08570112	cm. 120x21x5h	417,00
08570113	cm. 130x21x5h	432,00
08570114	cm. 140x21x5h	441,00
08570115	cm. 150x21x5h	455,00
08570116	cm. 160x21x5h	468,00

CORRIMANO

- Handrail / • Hand Lauf
- Main courante / • **Pasamano**

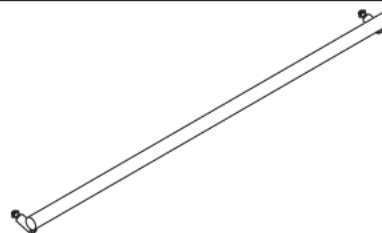

08570002	cm. 20x7x4h	275,00
08570003	cm. 30x7x4h	280,00
08570004	cm. 40x7x4h	284,00
08570005	cm. 50x7x4h	292,00
08570006	cm. 60x7x4h	301,00
08570007	cm. 70x7x4h	307,00
08570008	cm. 80x7x4h	311,00
08570009	cm. 90x7x4h	315,00
08570010	cm. 100x7x4h	320,00
08570011	cm. 110x7x4h	331,00
08570012	cm. 120x7x4h	339,00
08570013	cm. 130x7x4h	350,00
08570014	cm. 140x7x4h	362,00
08570015	cm. 150x7x4h	395,00
08570016	cm. 160x7x4h	427,00

SUPERLOTUS 70

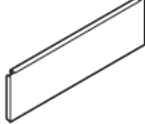
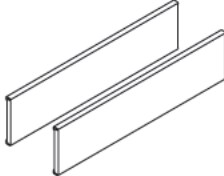
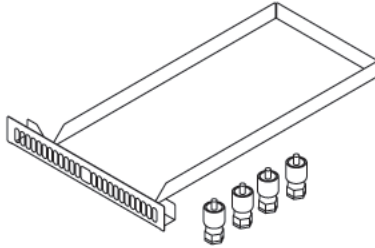
MOD. COD.	DESCRIZIONE/DESCRIPTION/BEZEICHNUNG/DESCRIPTION/DESCRIPCIÓN DIMENSIONI/DIMENSIONS/ABMESSUNGEN/DIMENSIONS/DIMENSIONES		PREZZO/PRICE € PREIS/PRIZ/PRECIO € KG / M ³
533116300	Giunzione corrimano • Junction handrail • Gelenk Hand lauf • Main courante de l'embranchement • Conexión pasamano Ø cm. 3x2,4		43,00
ZB	ZOCOLATURA BASE • Front plinth • Grundsockel • Plinthe frontal • Zocolos base a mt.		116,00
FZ-7 08480001	ZOCOLATURA LATERALE - KIT • Side plinth - kit • Seitensockel - kit • Plinthe lateral - kit • Zocolos lateral - kit cm. 1,5x61x6h		237,00
CZ-72 08480002	CASSETTO ZOCOLO - KIT • Drawer clog - kit • Schubladen sockel - kit • Tiroir plinthe - kit • Cajon zocolos - kit cm. 20x61x5,5h		139,00
CZ-74 08480004	cm. 40x61x5,5h		185,00
CZ-76 08480006	cm. 60x61x5,5h		244,00
CZ-78 08480008	cm. 80x61x5,5h		306,00
CZ-712 08480012	cm. 120x61x5,5h		427,00