



# LÍNEA 90



**COCINAS PROFESIONALES EQUIPADAS  
HASTA EL MÍNIMO DETALLE**



CONJUNTO LÍNEA 90

LÍNEA 90



**BAÑO MARÍA  
A GAS**  
BM-94G



**SARTÉN BASCULANTE  
A GAS**  
BR80-98GF/I



**CUECEPASTAS  
ELÉCTRICO**  
CP-94ET



**FRY-TOP A GAS + PUERTAS**  
FTL-916GS



**CUECEPASTAS A GAS  
CON ELEVADOR CESTAS**  
CPPA-94G+SCCP-92EM



**WOK ELÉCTRICO CON  
REGULADOR DIGITAL**  
PCIWT-94ETD



**COCINA INDUCCIÓN CON  
REGULADOR DIGITAL**  
PCIT-94ETD

## LÍNEA 90



**BARBACOA  
ELÉCTRICA**  
CWK-98ET



**FREIDORA DOBLE  
ELÉCTRICA**  
F2/18-98ET



**COCINA A GAS CON  
SISTEMA AGUA+PUERTAS**  
PCA-98G



**MARMITA A GAS**  
PH150-98G



**COCINA A GAS CON HORNO  
Y PLACA RADIANTE**  
TPF4-912G



**PLACA RADIANTE A GAS**  
TPT-98G













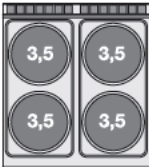

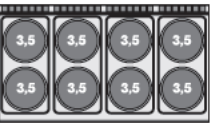

**COCINA A GAS**  
PCT-98G







## IPERLOTUS 90 TOP

MOD. / COD.	DESCRIZIONE / DESCRIPTION / BEZEICHNUNG / DESCRIPTION / DESCRIPCIÓN DIMENSIONI / DIMENSIONS / ABMESSUNGEN / DIMENSIONS / DIMENSIONES	POTENZA / POWER / LEISTUNG / PUISSANCE / POTENCIA VOLTAGGIO / VOLTAGE / SPANNUNG / VOLTAGE / VOLTAJE	⊕ kW kcal/h	⊖ kW V- Hz	PREZZO / PRICE PREIS / PRIX / PRECIO € KG / M <sup>3</sup>
<b>PLT-92</b> 19010200	PIANO LAVORO • Worktop • Arbeitsplatte • Plan de travail • <b>Sobre de trabajo</b> <b>cm. 20x90x28h</b>				<b>546,00</b> 18 / 0,12
<b>PLST-94</b> 19010401	<b>cm. 40x90x28h</b>				<b>578,00</b> 23 / 0,18
<b>PLST-96</b> 19010601	<b>cm. 60x90x28h</b>				<b>930,00</b> 29 / 0,28
<b>PLST-98</b> 19010801	<b>cm. 80x90x28h</b>				<b>1.035,00</b> 35 / 0,35
<b>PLT-94</b> 19010400	PIANO LAVORO Cassetto con 1 bacinella GN 1/1 15h plastica • Worktop - Drawer with 1 plastic container GN 1/1 15h • Arbeitsplatte - Schublade mit 1 GN 1/1 15h Kunststoffbehälter • Plan de travail - Tiroir avec bac en plastique GN 1/1 15h • <b>Sobre de trabajo Cajón con 1 contenedor</b> <b>GN 1/1 15h plástico</b> <b>cm. 40x90x28h</b>				<b>772,00</b> 28 / 0,18
<b>PLT-96</b> 19010600	PIANO LAVORO Cassetto 49,5x50x15h inox • Worktop - Drawer cm. 49,5x50x15h • Arbeitsplatte - Schublade cm. 49,5x50x15h • Plan de travail - Tiroir inox cm. 49,5x50x15h • <b>Sobre de trabajo. Cajón cm. 49,5x50x15h inox</b> <b>cm. 60x90x28h</b>				<b>1.147,00</b> 38 / 0,28
<b>PLT-98</b> 19010800	PIANO LAVORO Cassetto con 2 bacinelle GN 1/1 15h plastica • Worktop - Drawer with 2 plastic containers GN 1/1 15h • Arbeitsplatte - Schublade mit 2 GN 1/1 15h Kunststoffbehältern • Plan de travail - Tiroir avec 2 bacs en plastique GN 1/1 15h • <b>Sobre de trabajo Cajón con 2 contenedores</b> <b>GN 1/1 15h plástico</b> <b>cm. 80x90x28h</b>				<b>1.273,00</b> 46 / 0,35
<b>LAT-94</b> 19020400	LAVELLO Rubinetto a leva - Vasca cm. 30x35x15h • Sink unit - Lever type tap - Bowl cm. 30x35x15h • Spülbecken - Einhebel-Mischbatterie Becken cm. 30x35x15h • Bac-évier avec robinetterie - Bac cm 30x35x15h • <b>Fregadero - Grifo a palanca - Pileta cm. 30x35x15h</b> <b>cm. 40x90x28h</b>				<b>1.005,00</b> 24 / 0,18



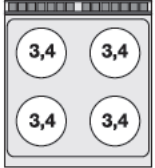





# IPERLOTUS 90 TOP

MOD. COD.	DESCRIZIONE / DESCRIPTION / BEZEICHNUNG / DESCRIPTION / DESCRIPCIÓN DIMENSIONI / DIMENSIONS / ABMESSUNGEN / DIMENSIONS / DIMENSIONES	POTENZA / POWER / LEISTUNG / PUISSANCE / POTENCIA VOLTAGGIO / VOLTAGE / SPANNUNG / VOLTAGE / VOLTAJE	$\frac{kW}{kcal/h}$ $\frac{kw}{V}$ Hz	PREZZO / PRICE PREIS / PRX / PRECIO € KG / M <sup>3</sup>
<b>PCT-94ET</b> 19030430	PIANO COTTURA TRIFASE N. 2 piastre • Boiling unit threephase - N. 2 plates • Kochplatte dreiphasig - N. 2 Kochplatten • Rechaud électriques - N. 2 plaques • <b>Sobre de cocción trifásico - N. 2 planchas</b> <b>cm. 40x90x28h</b>		$\frac{7}{400V \sim 2N}$ $\frac{230V \sim 3}{230V \sim}$ 50/60 Hz	<b>1.168,00</b> 29 / 0,18 
<b>PCT-98ET</b> 19030830	PIANO COTTURA TRIFASE N. 4 piastre • Boiling unit threephase - N. 4 plates • Kochplatte dreiphasig - N. 4 Kochplatten • Rechaud électriques - N. 4 plaques • <b>Sobre de cocción trifásico - N. 4 planchas</b> <b>cm. 80x90x28h</b>		$\frac{14}{400V \sim 3N}$ $\frac{230V \sim 3}{50/60 Hz}$	<b>2.350,00</b> 68 / 0,35 
<b>PCT-912ET</b> 19031230	PIANO COTTURA TRIFASE N. 6 piastre • Boiling unit threephase - N. 6 plates • Kochplatte dreiphasig - N. 6 Kochplatten • Rechaud électriques - N. 6 plaques • <b>Sobre de cocción trifásico - N. 6 planchas</b> <b>cm. 120x90x28h</b>		$\frac{21}{400V \sim 3N}$ $\frac{230V \sim 3}{50/60 Hz}$	<b>3.221,00</b> 94 / 0,51 
<b>PCT-916ET</b> 19031630	PIANO COTTURA TRIFASE - N. 8 piastre • Boiling unit threephase - N. 8 plates • Kochplatte dreiphasig - N. 8 Kochplatten • Rechaud triphase - N. 8 plaques • <b>Sobre de cocción trifásico - N. 8 planchas</b> <b>cm. 160x90x28h</b>		$\frac{28}{400V \sim 3N}$ $\frac{230V \sim 3}{50/60 Hz}$	<b>4.131,00</b> 131 / 0,68 
<b>PCQT-94ET</b> 19030431	PIANO COTTURA TRIFASE - N. 2 piastre quadre • Boiling unit threephase - N. 2 square plates • Kochplatte dreiphasig - N. 2 quadratischen Platten • Rechaud électriques - N. 2 plaques carrés • <b>Sobre de cocción trifásico - N. 2 planchas cuadradas</b> <b>cm. 40x90x28h</b>		$\frac{8}{400V \sim 2N}$ $\frac{230V \sim 3}{230V \sim}$ 50/60 Hz	<b>1.620,00</b> 33 / 0,18 
<b>PCQT-98ET</b> 19030831	PIANO COTTURA TRIFASE - N. 4 piastre quadre • Boiling unit threephase - N. 4 square plates • Kochplatte dreiphasig - N. 4 quadratischen Platten • Rechaud électriques - N. 4 plaques carrés • <b>Sobre de cocción trifásico - N. 4 planchas cuadradas</b> <b>cm. 80x90x28h</b>		$\frac{16}{400V \sim 3N}$ $\frac{230V \sim 3}{50/60 Hz}$	<b>2.995,00</b> 71 / 0,35 
<b>PCQT-912ET</b> 19031231	PIANO COTTURA TRIFASE - N. 6 piastre quadre • Boiling unit threephase - N. 6 square plates • Kochplatte dreiphasig - N. 6 quadratischen Platten • Rechaud électriques - N. 6 plaques carrés • <b>Sobre de cocción trifásico - N. 6 planchas cuadradas</b> <b>cm. 120x90x28h</b>		$\frac{24}{400V \sim 3N}$ $\frac{230V \sim 3}{50/60 Hz}$	<b>4.703,00</b> 112 / 0,51 
<b>PCQT-916ET</b> 19031631	PIANO COTTURA TRIFASE - N. 8 piastre quadre • Boiling unit threephase - N. 8 square plates • Kochplatte dreiphasig - N. 8 quadratischen Platten • Rechaud électriques - N. 8 plaques carrés • <b>Sobre de cocción trifásico - N. 8 planchas cuadradas</b> <b>cm. 160x90x28h</b>		$\frac{32}{400V \sim 3N}$ $\frac{230V \sim 3}{50/60 Hz}$	<b>5.851,00</b> 150 / 0,68 

# IPERLOTUS 90 TOP

MOD. / COD.	DESCRIZIONE / DESCRIPTION / BEZEICHNUNG / DESCRIPTION / DESCRIPCIÓN DIMENSIONI / DIMENSIONS / ABMESSUNGEN / DIMENSIONS / DIMENSIONES	POTENZA / POWER / LEISTUNG / PUISSANCE / POTENCIA VOLTAGGIO / VOLTAGE / SPANNUNG / VOLTAGE / VOLTAJE	⚡ kW kcal/h V~ Hz	PREZZO / PRICE PREIS / PRIX / PRECIO € KG / M <sup>3</sup>
<b>PCCT-94ET</b> 19030432	<p>PIANO COTTURA VETROCERAMICA TRIFASE - N. 2 zone - vetro cm.35x77</p> <ul style="list-style-type: none"> <li>• Ceramic glass boiling unit - n. 2 zones - glass cm.35x77</li> <li>• Ceran-Kochplatte dreiphasig - 2 zonen - Glas 35x77 cm</li> <li>• Plan de cuisson à vitroceramique triphasé N. 2 zones - Verre cm.35x77</li> </ul> <p><b>Sobre de cocción trifásico vitrocerámica - 2 zonas - vidrio cm.35x77 cm. 40x90x28h</b></p>		<p>6,8 kW 400V~2N 230V~3 230V~ 50/60 Hz</p>	<p><b>2.011,00</b> 38 / 0,18</p> 
<b>PCCT-98ET</b> 19030832	<p>PIANO COTTURA VETROCERAMICA TRIFASE - N. 4 zone - vetro cm.75x77</p> <ul style="list-style-type: none"> <li>• Ceramic glass boiling unit - n. 4 zones - glass cm.75x77</li> <li>• Ceran-Kochplatte dreiphasig - 4 zonen - Glas 75x77 cm</li> <li>• Plan de cuisson à vitroceramique triphasé N. 4 zones - Verre cm.75x77</li> </ul> <p><b>Sobre de cocción trifásico vitrocerámica - 4 zonas - vidrio cm.75x77 cm. 80x90x28h</b></p>		<p>13,6 kW 400V~3N 230V~3 50/60 Hz</p>	<p><b>3.523,00</b> 70 / 0,35</p> 
<b>PCIT-94ET</b> 19030433	<p>PIANO COTTURA INDUZIONE TRIFASE - N. 2 zone - Vetro cm.35x77 (non posizionare su forni o cassettiere)</p> <ul style="list-style-type: none"> <li>• Three-phase induction cooking - 2 zones - glass cm.35x77 (do not place on ovens or drawers)</li> <li>• Induktions-Kochplatte dreiphasig - 2 zonen - Glas 35x77 cm (nicht Platz auf Öfen oder Schubladen)</li> <li>• Plan de cuisson à induction triphasé N. 2 zones - Verre cm.35x77 (ne placez pas sur des fours ou des tiroirs)</li> </ul> <p><b>Encimera inducción trifásica - 2 zonas - Vidrio cm.35x77 (No coloque en los hornos o en los cajones) cm. 40x90x28h</b></p>		<p>10 kW 400V~3 50/60 Hz</p>	<p><b>6.901,00</b> 38 / 0,18</p>
<b>PCIT-94ETD</b> 19030438	<p>Comandi digitali</p> <ul style="list-style-type: none"> <li>• Digital controls / • Digitale Steuerungen</li> <li>• Commandes numériques / • <b>Controles digitales</b></li> </ul>			<p><b>7.391,00</b> 38 / 0,18</p>
<b>PCIWT-94ET</b> 19030434	<p>PIANO COTTURA INDUZIONE TRIFASE "WOK" - N. 1 zona - Vetro Ø 30 cm. (non posizionare su forni o cassettiere)</p> <ul style="list-style-type: none"> <li>• Three-phase induction cooking "WOK" - 1 zone - glass Ø 30 cm (do not place on ovens or drawers)</li> <li>• Induktions-Kochplatte "WOK" dreiphasig - 1 zonen - Glas Ø 30 cm (nicht Platz auf Öfen oder Schubladen)</li> <li>• Plan de cuisson à induction "WOK" triphasé N. 1 zone - Verre cm Ø 30 (ne placez pas sur des fours ou des tiroirs)</li> </ul> <p><b>Encimera inducción "WOK" trifásica - 1 zona - Vidrio Ø 30 cm (No coloque en los hornos o en los cajones) cm. 40x90x28h</b></p>		<p>5 kW 400V~3 50/60 Hz</p>	<p><b>5.046,00</b> 34 / 0,18</p>
<b>PCIWT-94ETD</b> 19030439	<p>Comandi digitali</p> <ul style="list-style-type: none"> <li>• Digital controls / • Digitale Steuerungen</li> <li>• Commandes numériques / • <b>Controles digitales</b></li> </ul>			<p><b>5.291,00</b> 34 / 0,18</p>
<b>PCIT-98ET</b> 19030833	<p>PIANO COTTURA INDUZIONE TRIFASE - N. 4 zone - Vetro cm.75x77 (non posizionare su forni o cassettiere)</p> <ul style="list-style-type: none"> <li>• Three-phase induction cooking - 4 zones - glass cm.75x77 (do not place on ovens or drawers)</li> <li>• Induktions-Kochplatte dreiphasig - 4 zonen - Glas 75x77 cm (nicht Platz auf Öfen oder Schubladen)</li> <li>• Plan de cuisson à induction triphasé N. 4 zones - Verre cm.75x77 (ne placez pas sur des fours ou des tiroirs)</li> </ul> <p><b>Encimera inducción trifásica - 4 zonas - Vidrio cm.75x77 (No coloque en los hornos o en los cajones) cm. 80x90x28h</b></p>		<p>20 kW 400V~3 50/60 Hz</p>	<p><b>13.249,00</b> 76 / 0,35</p>
<b>PCIT-98ETD</b> 19030838	<p>Comandi digitali</p> <ul style="list-style-type: none"> <li>• Digital controls / • Digitale Steuerungen</li> <li>• Commandes numériques / • <b>Controles digitales</b></li> </ul>			<p><b>14.229,00</b> 76 / 0,35</p>

# IPERLOTUS 90 TOP

MOD. COD.	DESCRIZIONE/DESCRIPTION/BEZEICHNUNG/DESCRIPTION/DESCRIPCIÓN DIMENSIONI/DIMENSIONS/ABMESSUNGEN/DIMENSIONS/DIMENSIONES	POTENZA/POWER/LEISTUNG/PUISSANCE/POTENCIA VOLTAGGIO/VOLTAGE/SPANNUNG/VOLTAGE/VOLTAJE	$\frac{kW}{kcal/h}$ $\frac{V}{Hz}$	PREZZO/PRICE € PREIS/PRICE/PRECO € KG / M <sup>3</sup>
<b>PCT-94G</b> 19210450	PIANO COTTURA GAS 2 fuochi • Gas heated boiling - 2 burners • Gas-Kochplatte - 2 Kochstellen • Rechaud gaz - 2 feuxvifs • <b>Sobres de cocción gas - 2 quemadores</b> <b>cm. 40x90x28h</b>		$\frac{11 kW}{9.460 kcal/h}$	<b>1.403,00</b> 64 / 0,18
<b>PCT-98G</b> 19210850	PIANO COTTURA GAS 4 fuochi • Gas heated boiling unit - 4 burners • Gas-Kochplatte - 4 Kochstellen • Rechaud gaz - 4 feuxvifs • <b>Sobres de cocción gas - 4 quemadores</b> <b>cm. 80x90x28h</b>		$\frac{28 kW}{24.080 kcal/h}$	<b>2.457,00</b> 80 / 0,35
<b>PCT-912G</b> 19211250	PIANO COTTURA GAS 6 fuochi • Gas heated boiling unit - 6 burners • Gas-kochplatte - 6 Kochstellen • Rechaud gaz - 6 feuxvifs • <b>Sobres de cocción gas - 6 quemadores</b> <b>cm. 120x90x28h</b>		$\frac{45 kW}{38.700 kcal/h}$	<b>3.461,00</b> 131 / 0,51
<b>PCT-916G</b> 19211650	PIANO COTTURA GAS 8 fuochi • Gas heated boiling unit - 8 burners • Gas-kochplatte - 8 Kochstellen • Rechaud gaz - 8 feuxvifs • <b>Sobres de cocción gas - 8 quemadores</b> <b>cm. 160x90x28h</b>		$\frac{56 kW}{48.160 kcal/h}$	<b>4.500,00</b> 168 / 0,68
<b>PAT-98G</b> 19210851	"PAELLERO" GAS • "PAELLERO" Gas • "PAELLERO" Gas • "PAELLERO" gaz • <b>"PAELLERO" gas</b> <b>cm. 80x90x28h</b>		$\frac{26,7 kW}{22.962 kcal/h}$	<b>3.604,00</b> 139 / 0,35
<b>TPT-94G</b> 19290450	TUTTA PIASTRA Piastra cm 37x73 • Solid top - Plate 37x73 cm • Kochplatte - Platte 37x73 cm • Toute plaque - Plaque cm 37x73 • <b>Placa de cocción - Placa cm 37x73</b> <b>cm. 40x90x28h</b>		$\frac{7 kW}{6.020 kcal/h}$	<b>1.771,00</b> 64 / 0,18
<b>TPT-98G</b> 19290850	TUTTA PIASTRA Piastra cm 77x73 • Solid top - Plate 77x73 cm • Kochplatte - Platte 77x73 cm • Toute plaque - Plaque cm. 77x73 • <b>Placa de cocción - Placa cm 77x73</b> <b>cm. 80x90x28h</b>		$\frac{12 kW}{10.320 kcal/h}$	<b>2.600,00</b> 137 / 0,35
<b>TPT-98ET</b> 19120830	TUTTA PIASTRA Piastra cm. 70x68 - 4 zone • Solid top - Plate cm. 70x68 • Kochplatten - Platte cm. 70x68 • Toute plaque - Plaque cm. 70x68 • <b>Placa de cocción - Placa cm. 70x68</b> <b>cm. 80x90x28h</b>		$\frac{13,6 kW}{400V\sim 3N}$ 50/60 Hz	<b>3.277,00</b> 108 / 0,35

# IPERLOTUS 90 TOP

MOD. \_\_\_\_\_ DESCRIZIONE/DESCRIPTION/BEZEICHNUNG/DESCRIPTION/DESCRIPCIÓN POTENZA/POWER/LEISTUNG/PUISSANCE/POTENCIA ⚡ kW ⚡ kw PREZZO/PRICE €  
 COD. \_\_\_\_\_ DIMENSIONI/DIMENSIONS/ABMESSUNGEN/DIMENSIONS/DIMENSIONES VOLTAGGIO/VOLTAGE/SPANNUNG/VOLTAGE/VOLTAJE kcal/h kcal/h V- PREIS/PRIX/PRECIO €  
 KG / M³

**TPIT-98ET** TUTTOPIANO INDUZIONE TRIFASE - Vetro  
 19120833 cm.75x77 (non posizionare su forni o cassettiere)  
 • Three-phase induction Solid top - glass cm.75x77 (do not place on ovens or drawers)  
 • Induktions-Kochplatte dreiphasig - Glas 75x77 cm (nicht Platz auf Öfen oder Schubladen)  
 • Toute plaque à induction triphasé - Verre cm.75x77 (ne placez pas sur des fours ou des tiroirs)  
 • **Placa de cocción inducción trifásica - Vidrio cm.75x77 (No coloque en los hornos o en los cajones) cm. 80x90x28h**



⚡ 28 kW **19.659,00**  
 400V~3 80 / 0,35  
 50/60 Hz

**TPIT-98ETD** Comandi digitali  
 19120838 • Digital controls / • Digitale Steuerungen  
 • Commandes numériques / • **Controles digitales**

**20.639,00**  
 80 / 0,35

**TP2T-98G** TUTTA PIASTRA + 2 FUOCHI -  
 19300850 Piastra cm 37x73  
 • Solid top + 2 burners - Plate 37x73 cm  
 • Kochplatte + 2 Gaskochstellen - Platte 37x73 cm  
 • Toute plaque + 2 brûleurs - Plaque cm 37x73  
 • **Placa de cocción + 2 fuegos - Placa cm 37x73 cm. 80x90x28h**

⚡ 24 kW **2.666,00**  
 20.640 kcal/h 130 / 0,35

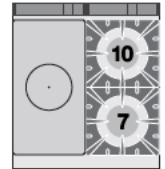

**TP2T-912G** TUTTA PIASTRA + 2 FUOCHI Piastra cm. 77x73  
 19291250 • Solid top + 2 burners - Plate 77x73 cm  
 • Kochplatte + 2 Gaskochstellen - Platte 77x73 cm  
 • Toute plaque + 2 brûleurs - Plaque cm. 77x73  
 • **Placa de cocción + 2 fuegos - Placa cm. 77x73 cm. 120x90x28h**



⚡ 29 kW **3.866,00**  
 24.940 kcal/h 157 / 0,51

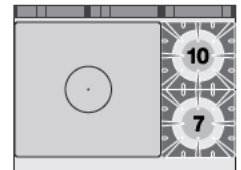

**TP4T-912G** TUTTA PIASTRA + 4 FUOCHI Piastra cm. 37x73  
 19301250 • Solid top + 4 burners - Plate 37x73 cm  
 • Kochplatte + 4 Gaskochstellen - Platte 37x73 cm  
 • Toute plaque + 4 brûleurs - Plaque cm. 37x73  
 • **Placa de cocción + 4 fuegos - Placa cm. 37x73 cm. 120x90x28h**



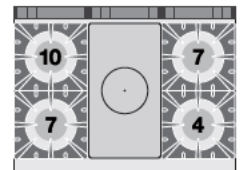

⚡ 35 kW **3.646,00**  
 30.100 kcal/h 155 / 0,51





















## IPERLOTUS 90 TOP

MOD. COD.	DESCRIZIONE / DESCRIPTION / BEZEICHNUNG / DESCRIPTION / DESCRIPCIÓN DIMENSIONI / DIMENSIONS / ABMESSUNGEN / DIMENSIONS / DIMENSIONES	POTENZA / POWER / LEISTUNG / PUISSANCE / POTENCIA VOLTAGGIO / VOLTAGE / SPANNUNG / VOLTAGE / VOLTAJE	⚡ kW kcal/h	⚡ kw V~ Hz	PREZZO / PRICE € PREIS / PRIX / PRECIO € KG / M <sup>3</sup>
<b>BMT-94EM</b> 19050410	<b>BAGNOMARIA MONOFASE</b> Vasca per GN 1/1 + GN 1/3 h.15 • Bain marie singlephase - Bowl for GN 1/1 + GN 1/3 h.15 • Wasserbäder einphasig - Becken GN 1/1 + GN 1/3 h.15 • Bain marie monophasé - Cuve GN 1/1 + GN 1/3 h.15 • <b>Baño de maría monofásico -</b> <b>Cuba para GN 1/1 + GN 1/3 15h</b> <b>cm. 40x90x28h</b>		⚡ 2,85 kW 230V~ 50/60 Hz		<b>1.379,00</b> 39 / 0,18
<b>BMT-94G</b> 19220450	<b>BAGNOMARIA GAS</b> Vasca per GN 1/1 + GN 1/3 h.15 • Gas bain-marie - Bowl for GN 1/1 + GN 1/3 h.15 • Gas Wasserbad - Becken GN 1/1 + GN 1/3 h.15 • Bain-marie gaz - Cuve pour GN 1/1 + GN 1/3 h.15 • <b>Baño de maría gas -</b> <b>Cuba para GN 1/1 + GN 1/3 15h</b> <b>cm. 40x90x28h</b>		⚡ 3,5 kW 3.010 kcal/h		<b>1.638,00</b> 48 / 0,18
<b>BMT-98ET</b> 19050830	<b>BAGNOMARIA TRIFASE</b> Vasca per GN 2/1 + 2 xGN 1/3 h.15 • Bain marie threephase - Bowl for GN 2/1 + 2 xGN 1/3 h.15 • Wasserbäder dreiphasig - Becken GN 2/1 + 2 xGN 1/3 h.15 • Bain marie triphase - Cuve GN 2/1 + 2 xGN 1/3 h.15 • <b>Baño de maría trifásico -</b> <b>Cuba para GN 2/1 + 2 xGN 1/3 h.15</b> <b>cm. 80x90x28h</b>		⚡ 5,7 kW 400V~3N 230V~3 50/60 Hz		<b>1.969,00</b> 54 / 0,35
<b>BMT-98G</b> 19220850	<b>BAGNOMARIA GAS</b> Vasca per GN 2/1 + 2 xGN 1/3 h.15 • Gas bain-marie - Bowl for GN 2/1 + 2 xGN 1/3 h.15 • Gas Wasserbad - Becken GN 2/1 + 2 xGN 1/3 h.15 • Bain-marie gaz - Cuve pour GN 2/1 + 2 xGN 1/3 h.15 • <b>Baño de maría gas -</b> <b>Cuba para GN 2/1 + 2 xGN 1/3 15h</b> <b>cm. 80x90x28h</b>		⚡ 6,5 kW 5.590 kcal/h		<b>2.402,00</b> 61 / 0,35
<b>BST-94EM</b> 19040410	<b>CONTENITORE CALDO CON INFRAROSSO MONOFASE</b> Vasca cm. 30,5x51x16,5h con falsofondo forato • Fry dump singlephase with infra-red heater. Bowl cm. 30,5x51x16,5h with perforated double bottom • Frittenwanne Einphasig mit Infrarot-strahler. Becke cm. 30,5x51x16,5h mit gelochtem Bodenrost • Silo a frites monophasé avec infrarouge. Cuve cm 30,5x51x16,5h avec double-fond perforé. • <b>Contenedor caliente por infrarrojo monofásico.</b> <b>Cuba cm. 30,5x51x16,5h con falso</b> <b>fondo agujereado</b> <b>cm. 40x90x28h</b>		⚡ 1,47 kW 230V~ 50/60 Hz		<b>1.412,00</b> 48 / 0,18

# IPERLOTUS 90 TOP

MOD. COD.	DESCRIZIONE / DESCRIPTION / BEZEICHNUNG / DESCRIPTION / DESCRIPCIÓN DIMENSIONI / DIMENSIONS / ABMESSUNGEN / DIMENSIONS / DIMENSIONES	POTENZA / POWER / LEISTUNG / PUISSANCE / POTENCIA VOLTAGGIO / VOLTAGE / SPANNUNG / VOLTAGE / VOLTAJE	⊕ kW kcal/h	⊖ kw V- Hz	PREZZO / PRICE PREIS / PRD / PRECIO € KG / M <sup>3</sup>
<b>FTLT-94ET</b> 19060431 	FRY-TOP LISCIO TRIFASE Piastra cm. 36x68 • Fry-top smooth griddle threephase Plate cm. 36x68 • Griddleplatte glatt dreiphasig Platte cm. 36x68 • Plaque lisse triphase Plaque cm. 36x68 • <b>Fry-top liso trifásico Plancha cm. 36x68</b>		7,5 kW	400V~3N 50/60 Hz	<b>1.877,00</b> 69 / 0,18
<b>FTRT-94ET</b> 19060433 	FRY-TOP RIGATO TRIFASE Piastra cm. 36x68 • Fry-top grooved griddle threephase Plate cm. 36x68 • Griddleplatte gerillt dreiphasig Platte cm. 36x68 • Plaque nervurée triphase Plaque cm. 36x68 • <b>Fry-top estriado trifásico Plancha cm. 36x68</b>				<b>1.995,00</b> 69 / 0,18
<b>FTLT-94ETS</b> 19060434 	FRY-TOP LISCIO CROMATO TRIFASE Piastra cm. 36x68 • Fry-top chromed smooth griddle threephase Plate cm. 36x68 • Griddleplatte glatt hartverchromt dreiphasig Platte cm. 36x68 • Plaque lisse chromée triphase Plaque cm. 36x68 • <b>Fry-top liso cromado trifásico Plancha cm. 36x68</b>				<b>2.353,00</b> 69 / 0,18
<b>FTRT-94ETS</b> 19060436 	FRY-TOP RIGATO CROMATO TRIFASE Piastra cm. 36x68 • Fry-top grooved chromed griddle threephase Plate cm. 36x68 • Griddleplatte gerillt hartverchromt dreiphasig Platte cm. 36x68 • Plaque nervurée chromée triphase Plaque cm. 36x68 • <b>Fry-top estriado cromado trifásico Plancha cm. 36x68</b> <b>cm. 40x90x28h</b>				<b>2.466,00</b> 69 / 0,18
<b>FTLT-94G</b> 19230451 	FRY-TOP LISCIO GAS Piastra cm. 36x68 • Fry-top smooth griddle gas Plate cm. 36x68 • Gas-Griddleplatte glatt Platte cm. 36x68 • Plaque lisse gaz Plaque cm. 36x68 • <b>Fry-top liso gas Plancha cm. 36x68</b>		9 kW	7.7440 kcal/h	<b>1.958,00</b> 71 / 0,18
<b>FTRT-94G</b> 19230453 	FRY-TOP RIGATO GAS Piastra cm. 36x68 • Fry-top grooved griddle gas Plate cm. 36x68 • Gas-Griddleplatte gerillt Platte cm. 36x68 • Plaque nervurée gaz Plaque cm. 36x68 • <b>Fry-top estriado gas Plancha cm. 36x68</b>				<b>2.053,00</b> 71 / 0,18
<b>FTLT-94GS</b> 19230454 	FRY-TOP LISCIO CROMATO GAS Piastra cm. 36x68 • Fry-top chromed smooth griddle gas Plate cm. 36x68 • Gas-Griddleplatte glatt hartverchromt Platte cm. 36x68 • Plaque lisse chrome gaz Plaque cm. 36x68 • <b>Fry-top liso cromado gas Plancha cm. 36x68</b>				<b>2.346,00</b> 71 / 0,18
<b>FTRT-94GS</b> 19230456 	FRY-TOP RIGATO CROMATO GAS Piastra cm. 36x68 • Fry-top grooved chromed griddle gas Plate cm. 36x68 • Gas-Griddleplatte gerillt hartverchromt Platte cm. 36x68 • Plaque nervurée chromée gaz Plaque cm. 36x68 • <b>Fry-top estriado cromado gas Plancha cm. 36x68</b> <b>cm. 40x90x28h</b>				<b>2.456,00</b> 71 / 0,18

## IPERLOTUS 90 TOP

MOD. COD.	DESCRIZIONE/DESCRIPTION/BEZEICHNUNG/DESCRIPTION/DESCRIPCIÓN DIMENSIONI/DIMENSIONS/ABMESSUNGEN/DIMENSIONS/DIMENSIONES	POTENZA/POWER/LEISTUNG/PUISSANCE/POTENCIA VOLTAGGIO/VOLTAGE/SPANUNG/VOLTAGE/VOLTAGE	$\frac{kW}{kcal/h}$ $\frac{kW}{V-}$ Hz	PREZZO/PRICE € PREIS/PRIX/PRECIO € KG / M <sup>3</sup>
<b>FTLT-98ET</b> 19060831	<p>FRY-TOP LISCIO TRIFASE</p> <p>Piastra cm. 76x68, 2 zone di cottura</p> <ul style="list-style-type: none"> <li>Fry-top smooth griddle threephase Plate cm. 76x68, 2 cooking areas</li> <li>Griddleplatte glatt dreiphasig Platte cm. 76x68, 2 Heizzonen</li> <li>Plaque lisse triphase Plaque cm. 76x68, 2 zones de cuisson</li> <li><b>Fry-top liso trifásico Plancha cm. 76x68, 2 zonas de cocción</b></li> </ul>		$\neq$ 15 kW 400V~3N 50/60 Hz	<b>2.781,00</b> 103 / 0,41
				
<b>FTLRT-98ET</b> 19060832	<p>FRY-TOP 1/2 LISCIO + 1/2 RIGATO TRIFASE</p> <p>Piastra cm. 76x68, 2 zone di cottura</p> <ul style="list-style-type: none"> <li>Fry-top 1/2 smooth + 1/2 grooved griddle threephase Plate cm. 76x68, 2 cooking areas</li> <li>Griddleplatte 1/2 glatt + 1/2 gerillt dreiphasig Platte cm. 76x68, 2 Heizzonen</li> <li>Plaque 1/2 lisse + 1/2 nervurée triphase Plaque cm. 76x68, 2 zones de cuisson</li> <li><b>Fry-top 1/2 liso + 1/2 estriado trifásico Plancha cm. 76x68, 2 zonas de cocción</b></li> </ul>			<b>2.920,00</b> 103 / 0,41
				
<b>FTRT-98ET</b> 19060833	<p>FRY-TOP RIGATO TRIFASE</p> <p>Piastra cm. 76x68, 2 zone di cottura</p> <ul style="list-style-type: none"> <li>Fry-top grooved griddle threephase Plate cm. 76x68, 2 cooking areas</li> <li>Griddleplatte gerillt dreiphasig Platte cm. 76x68, 2 Heizzonen</li> <li>Plaque nervurée triphase Plaque cm. 76x68, 2 zones de cuisson</li> <li><b>Fry-top estriado trifásico Plancha cm. 76x68, 2 zonas de cocción</b></li> </ul>			<b>3.062,00</b> 103 / 0,41
				
<b>FTLT-98ETS</b> 19060834	<p>FRY-TOP LISCIO CROMATO TRIFASE</p> <p>Piastra cm. 76x68, 2 zone di cottura</p> <ul style="list-style-type: none"> <li>Fry-top chromed smooth griddle threephase Plate cm. 76x68, 2 cooking areas</li> <li>Griddleplatte glatt hartverchromt dreiphasig Platte cm. 76x68, 2 Heizzonen</li> <li>Plaque lisse chromée triphase Plaque cm. 76x68, 2 zones de cuisson</li> <li><b>Fry-top liso cromado trifásico Plancha cm. 76x68, 2 zonas de cocción</b></li> </ul>			<b>3.415,00</b> 103 / 0,41
				
<b>FTLRT-98ETS</b> 19060835	<p>FRY-TOP 1/2 LISCIO + 1/2 RIGATO CROMATO TRIFASE</p> <p>Piastra cm. 76x68, 2 zone di cottura</p> <ul style="list-style-type: none"> <li>Fry-top 1/2 smooth + 1/2 grooved griddle threephase Plate cm. 76x68, 2 cooking areas</li> <li>Griddleplatte 1/2 glatt + 1/2 gerillt dreiphasig Platte cm. 76x68, 2 Heizzonen</li> <li>Plaque 1/2 lisse + 1/2 nervurée triphase Plaque cm. 76x68, 2 zones de cuisson</li> <li><b>Fry-top 1/2 liso + 1/2 estriado trifásico Plancha cm. 76x68, 2 zonas de cocción</b></li> </ul>			<b>3.552,00</b> 103 / 0,41
				
<b>FTRT-98ETS</b> 19060836	<p>FRY-TOP RIGATO CROMATO TRIFASE</p> <p>Piastra cm. 76x68, 2 zone di cottura</p> <ul style="list-style-type: none"> <li>Fry-top grooved chromed griddle threephase Plate cm. 76x68, 2 cooking areas</li> <li>Griddleplatte gerillt hartverchromt dreiphasig Platte cm. 76x68, 2 Heizzonen</li> <li>Plaque nervurée chromée triphase Plaque cm. 76x68, 2 zones de cuisson</li> <li><b>Fry-top estriado cromado trifásico Plancha cm. 76x68, 2 zonas de cocción cm. 80x90x28h</b></li> </ul>			<b>3.690,00</b> 103 / 0,41
				

# IPERLOTUS 90 TOP

MOD. COD. DESCRIZIONE/DESCRIPTION/BEZEICHNUNG/DESCRIPTION/DESCRIPCIÓN DIMENSIONI/DIMENSIONS/ABMESSUNGEN/DIMENSIONS/DIMENSIONES POTENZA/POWER/LEISTUNG/PUISSANCE/POTENCIA VOLTAGGIO/VOLTAGE/SPANNUNG/VOLTAGE/VOLTAJE  $\frac{kW}{kcal/h}$   $\frac{kw}{V\sim}$  Hz PREZZO/PRICE € PREIS/PRIX/PRECIO € KG / M<sup>3</sup>

**FTLT-98G**  
19230851

FRY-TOP LISCIO GAS Piastra cm. 76x68, 2 zone di cottura

- Fry-top smooth griddle gas Plate cm. 76x68, 2 cooking areas
- Gas-Griddleplatte glatt Platte cm. 76x68, 2 Heizzonen
- Plaque lisse gaz Plaque cm. 76x68, 2 zones de cuisson
- Fry-top liso gas Plancha cm. 76x68, 2 zonas de cocción**



18 kW  
15.480 kcal/h

**3.004,00**  
108 / 0,41

**FLRT-98G**  
19230852

FRY-TOP 1/2 LISCIO + 1/2 RIGATO GAS

Piastra cm. 76x68, 2 zone di cottura

- Fry-top 1/2 smooth + 1/2 grooved griddle gas Plate cm. 76x68, 2 cooking areas
- Gas-Griddleplatte 1/2 glatt + 1/2 gerillt Platte cm. 76x68, 2 Heizzonen
- Plaque 1/2 lisse + 1/2 nervurée gaz Plaque cm. 76x68, 2 zones de cuisson
- Fry-top 1/2 liso + 1/2 estriado gas Plancha cm. 76x68, 2 zonas de cocción**



**3.144,00**  
108 / 0,41

**FRT-98G**  
19230853

FRY-TOP RIGATO GAS Piastra cm. 76x68, 2 zone di cottura

- Fry-top grooved griddle gas Plate cm. 76x68, 2 cooking areas
- Gas-Griddleplatte gerillt Platte cm. 76x68, 2 Heizzonen
- Plaque nervurée gaz Plaque cm. 76x68, 2 zones de cuisson
- Fry-top estriado gas Plancha cm. 76x68, 2 zonas de cocción**



**3.281,00**  
108 / 0,41

**FTLT-98GS**  
19230854

FRY-TOP LISCIO CROMATO GAS

Piastra cm. 76x68, 2 zone di cottura

- Fry-top chromed smooth griddle gas Plate cm. 76x68, 2 cooking areas
- Gas-Griddleplatte glatt hartverchromt Platte cm. 76x68, 2 Heizzonen
- Plaque lisse chromée triphase Plaque cm. 76x68, 2 zones de cuisson
- Fry-top liso cromado gas Plancha cm. 76x68, 2 zonas de cocción**



**3.736,00**  
108 / 0,41

**FLRT-98GS**  
19230855

FRY-TOP 1/2 LISCIO + 1/2 RIGATO CROMATO GAS

Piastra cm. 76x68, 2 zone di cottura

- Fry-top 1/2 smooth + 1/2 grooved chromed griddle threephase Plate cm. 76x68, 2 cooking areas
- Gas-Griddleplatte 1/2 glatt + 1/2 gerillt hartverchromt Platte cm. 76x68, 2 Heizzonen
- Plaque 1/2 lisse + 1/2 nervurée chromée gaz Plaque cm. 76x68, 2 zones de cuisson
- Fry-top 1/2 liso + 1/2 estriado cromado gas Plancha cm. 76x68, 2 zonas de cocción**



**3.879,00**  
108 / 0,41

**FRT-98GS**  
19230856

FRY-TOP RIGATO CROMATO GAS Piastra cm. 76x68, 2 zone di cottura

- Fry-top grooved chromed griddle gas Plate cm. 76x68, 2 cooking areas
- Gas-Griddleplatte gerillt hartverchromt Platte cm. 76x68, 2 Heizzonen
- Plaque nervurée chromée gaz Plaque cm. 76x68, 2 zones de cuisson
- Fry-top estriado cromado gas Plancha cm. 76x68, 2 zonas de cocción cm. 80x90x28h**



**4.026,00**  
108 / 0,41

**FTCT-94ET**  
19060437

FRY-TOP VETROCERAMICA TRIFASE Piastra cm. 36x68

- Fry-top ceramic glass threephase Plate cm. 36x68
- Griddleplatte Ceran-Kochplatten dreiphasig Platte cm. 36x68
- Plaque vitrocéramique triphase Plaque cm. 36x68
- Fry-top vitroceramica trifásico Plancha cm. 36x68 cm. 40x90x28h**



3,5 kW  
400V~3N  
230V~3  
230V~  
50/60 Hz

**2.810,00**  
66 / 0,18

**FTCT-98ET**  
19060837

FRY-TOP VETROCERAMICA TRIFASE

Piastra cm. 76x68, 2 zone di cottura

- Fry-top ceramic glass threephase Plate cm. 76x68, 2 cooking areas
- Griddleplatte Ceran-Kochplatten dreiphasig Platte cm. 76x68, 2 Heizzonen
- Plaque vitrocéramique triphase Plaque cm. 76x68, 2 zones de cuisson
- Fry-top vitroceramica trifásico Plancha cm. 76x68, 2 zonas de cocción cm. 80x90x28h**



7 kW  
400V~3N  
230V~3  
230V~  
50/60 Hz

**4.694,00**  
92 / 0,41

# IPERLOTUS 90 TOP

MOD. COD.	DESCRIZIONE/DESCRIPTION/BEZEICHNUNG/DESCRIPTION/DESCRIPCIÓN DIMENSIONI/DIMENSIONS/ABMESSUNGEN/DIMENSIONS/DIMENSIONES	POTENZA/POWER/LEISTUNG/PUISSANCE/POTENCIA VOLTAGGIO/VOLTAGE/SPANIUNG/VOLTAGE/VOLTAGE	⚡ kW kcal/h	⚡ kw V~ Hz	PREZZO/PRICE € PREIS/PRIX/PRECIO € KG / M <sup>3</sup>
<b>CWT-94ET</b> 19080430	<b>GRIGLIA TRIFASE</b> Griglia in acciaio inox cm. 38x66 regolabile • Grill threephase - Stainless steel grill cm. 38x66 • Wurstbrater dreiphasig - Einstellbarer Rost aus Nirosta cm. 38x66 • Grillade triphase - Grille inox cm 38x66 <b>• Parrilla trifásico - Parrilla de acero inoxregulable cm 38x66 cm. 40x90x28h</b>		7,8 kW 400V~3N 50/60 Hz		<b>2.052,00</b> 57 / 0,21
<b>CWT-94G</b> 19250450	<b>GRIGLIA GAS-PIETRALAVICA</b> Griglia in acciaio inox cm. 38x66 regolabile • Charcoal grill gas - Stainless steel grill cm. 38x66 • Gas-Lavasteingrill - Einstellbarer Rost aus Nirosta cm. 38x66 • Grille à gaz en pierre de lave - Grille inox cm 38x66 <b>• Parrilla a gas piedra lávica - Parrilla de acero inoxregulable cm 38x66 cm. 40x90x28h</b>		12 kW 10.320 kcal/h		<b>2.106,00</b> 56 / 0,21
<b>CWT-98ET</b> 19080830	<b>GRIGLIA TRIFASE N. 2</b> griglie in acciaio inox cm. 38x66 regolabili 2 zone di cottura • Grill threephase - N. 2 Stainless steel grill cm. 38x66. 2 cooking areas • Wurstbrater dreiphasig - N. 2 einstellbare Roste aus Nirosta cm. 38x66 - 2 Heizzonen • Grillade triphase - N. 2 grilles réglables en acier inox cm. 38x66 - 2 zones de cuisson <b>• Parrilla trifásico - N. 2 Parrillas de acero inoxregulable cm 38x66 - 2 zonas de cocción cm. 80x90x28h</b>		15,6 kW 400V~3N 50/60 Hz		<b>3.122,00</b> 87 / 0,41
<b>CWT-98G</b> 19250850	<b>GRIGLIA GAS-PIETRALAVICA N. 2</b> griglie in acciaio inox cm. 38x66 regolabili 2 zone di cottura • Charcoal grill gas - N. 2 Stainless steel grill cm. 38x66 2 cooking areas • Gas-Lavasteingrill - N. 2 einstellbare Roste aus Nirosta cm. 38x66 - 2 Heizzonen • Grille a gaz en pierre de lave - N. 2 grilles réglables en acier inox cm. 38x66 - 2 zones de cuisson <b>• Parrilla a gas piedra lávica - N. 2 Parrillas de acero inoxregulable cm 38x66 - 2 zonas de cocción cm. 80x90x28h</b>		24 kW 20.640 kcal/h		<b>3.273,00</b> 97 / 0,41
<b>CWKT-94ET</b> 19080431	<b>GRIGLIA CONTACT</b> - cottura diretta su resistenza in acciaio inox cm. 27x63 ribaltabile • CONTACT Grill threephase - rotatable stainless steel grill cm. 27x63 • Wurstbrater dreiphasig KONTAKT - Drehbaren Heizelement aus Edelstahl cm. 27x63 • Grillade triphase CONTACT - Grille inoxrotatif cm 27x63 <b>• Parrilla trifásico CONTACT - Parrilla giratoria de acero inox cm 27x63 cm. 40x90x28h</b>		5,415 kW 400V~3N 50/60 Hz		<b>2.724,00</b> 55 / 0,21
<b>CWKT-98ET</b> 19080831	<b>GRIGLIA CONTACT</b> - cottura diretta su resistenza in acciaio inox cm. 55x63 ribaltabile - 2 zone cottura • CONTACT Grill threephase - rotatable stainless steel grill cm. 55x63 - 2 cooking areas • Wurstbrater dreiphasig KONTAKT - Drehbaren Heizelement aus Edelstahl cm. 55x63 - 2 Heizzonen • Grillade triphase CONTACT - Grille inoxrotatif cm 55x63 - 2 zones de cuisson <b>• Parrilla trifásico CONTACT - Parrilla giratoria de acero inox cm 55x63 - 2 zonas de cocción cm. 80x90x28h</b>		10,83 kW 400V~3N 50/60 Hz		<b>3.795,00</b> 85 / 0,41

# IPERLOTUS 90 TOP

MOD. / COD.	DESCRIZIONE / DESCRIPTION / BEZEICHNUNG / DESCRIPTION / DESCRIPCIÓN DIMENSIONI / DIMENSIONS / ABMESSUNGEN / DIMENSIONS / DIMENSIONES	POTENZA / POWER / LEISTUNG / PUISSANCE / POTENCIA VOLTAGGIO / VOLTAGE / SPANNUNG / VOLTAGE / VOLTAJE	$\begin{matrix} \text{kW} \\ \text{kcal/h} \end{matrix}$ / $\begin{matrix} \text{kW} \\ \text{V-} \\ \text{Hz} \end{matrix}$	PREZZO / PRICE / € PREIS / PRD. / PRECIO / € KG / M <sup>3</sup>
<b>F13T-94ET</b> 19090430	FRIGGITRICE TRIFASE LT. 13 Vasca cm. 30,5x34x22,5h - 1 cesto cm. 28x29x10h Filtro e coperchio vasca - Produzione patate: 10 kg/h <ul style="list-style-type: none"> <li>Fryer threephase 13 lts - Bowl cm. 30,5x34x22,5h 1 basket cm. 28x29x10h - Sieve and lid for pan Production: 10 kg/h</li> <li>Friteuse dreiphasig lt. 13 - Becken cm. 30,5x34x22,5h - 1 Korb cm. 28x29x10h - Einlegesieb und Deckel für Becken - Pommes frites: 10 kg/h</li> <li>Friteuse triphase lt. 13 - Cuve cm. 30,5x34x22,5h - 1 Panier cm. 28x29x10h - Filtre, couvercle pour cuve Production de pommes frites: 10 kg/h</li> </ul> <b>Freidoras trifásico 13 lt. - Cuba cm. 30,5x34x22,5h - 1 cesta cm. 28x29x10h - Filtro y tapa para cuba. Prod. patatas: 10 Kg/h cm. 40x90x28h</b>		$\begin{matrix} 11,95 \text{ kW} \\ 400\text{V}\sim\text{3N} \\ 50/60 \text{ Hz} \end{matrix}$	<b>2.342,00</b> 55 / 0,21
<b>F13T-94G</b> 19260450	FRIGGITRICE GAS LT. 13 - Vasca cm. 31,5x34,5x22,5h 1 cesto cm. 28x29x10h - Filtro e coperchio vasca. Prod. patate: 10 kg/h <ul style="list-style-type: none"> <li>Gas Fryer 13 lts - Bowl cm. 31,5x34,5x22,5h - 1 basket cm. 28x29x10h - Sieve and lid for pan Production: 10 kg/h</li> <li>Gas-Friteuse lt. 13 - Becken cm. 31,5x34,5x22,5h - 1 Korb cm. 28x29x10h - Einlegesieb und Deckel für Becken - Pommes frites: 10 kg/h</li> <li>Friteuse à gaz lt. 13 - Cuve cm. 31,5x34,5x22,5h - 1 Panier cm. 28x29x10h - Filtre, couvercle pour cuve Production de pommes frites: 10 kg/h</li> </ul> <b>Freidoras a gas 13 lt. - Cuba cm. 31,5x34,5x22,5h - 1 cesta cm. 28x29x10h - Filtro y tapa para cuba Prod. patatas: 10 Kg/h cm. 40x90x28h</b>		$\begin{matrix} 12 \text{ kW} \\ 10.320 \text{ kcal/h} \end{matrix}$	<b>2.612,00</b> 60 / 0,21
<b>F2/8T-94ET</b> 19090432	FRIGGITRICE TRIFASE LT. 8+8 2 Vasche cm. 14,8x35,5x22,5h - 2 cesti cm. 12x29x11,5h - Filtro e coperchio vasca. Produzione patate: 12 kg/h <ul style="list-style-type: none"> <li>Fryer threephase 8+8 lts - 2 Bowls cm. 14,8x35,5x22,5h - 2 baskets cm. 12x29x11,5h. Sieve and lid for pan. Production: 12 kg/h</li> <li>Friteuse dreiphasig lt. 8+8 - 2 Becken cm. 14,8x35,5x22,5h - 2 Korb cm. 12x29x11,5h. Einlegesieb und Deckel für Becken. Pommes frites: 12 kg/h</li> <li>Friteuse triphase lt. 8+8 - 2 Cuve cm. 14,8x35,5x22,5h - 2 Panier cm. 12x29x11,5h. Filtre, couvercle pour cuve. Production de pommes frites: 12 kg/h</li> </ul> <b>Freidoras trifásico 8+8 lt. - 2 Cuba cm. 14,8x35,5x22,5h- 2 cesta cm. 12x29x11,5h. Filtro y tapa para cuba. Prod. patatas: 12 Kg/h cm. 40x90x28h</b>		$\begin{matrix} 12 \text{ kW} \\ 400\text{V}\sim\text{3N} \\ 230\text{V}\sim\text{3} \\ 50/60 \text{ Hz} \end{matrix}$	<b>3.050,00</b> 58 / 0,21
<b>F2/8T-94G</b> 19260452	FRIGGITRICE GAS LT. 8+8 - 2 vasche cm. 15x35x23h 2 cesti cm. 12x30x9,5h. Filtro e coperchio vasca. Prod. patate: 12 kg/h <ul style="list-style-type: none"> <li>Gas Fryer 8+8 lts - 2 pans cm. 15x35x23h 2 baskets cm. 12x30x9,5h. Sieve and lid for pan. Production: 12 kg/h</li> <li>Gas-Friteuse lt. 8+8 - 2 Becken cm. 15x35x23h 2 Körbe cm. 12x30x9,5h. Einlegesieb und Deckel für Becken. Pommes frites: 12 kg/h</li> <li>Friteuse à gaz lt. 8+8 - 2 cuves cm. 15x35x23h 2 paniers cm. 12x30x9,5h. Filtre, couvercle pour cuve. Production de pommes frites: 12 kg/h</li> </ul> <b>Freidoras a gas 8+8 lt. - 2 cubas cm. 15x35x23h 2 cestas cm. 12x30x9,5h. Filtro y tapa para cuba. Prod. patatas: 12 Kg/h cm. 40x90x28h</b>		$\begin{matrix} 9 \text{ kW} \\ 7.740 \text{ kcal/h} \end{matrix}$	<b>3.575,00</b> 58 / 0,21
<b>F2/13T-98ET</b> 19090830	FRIGGITRICE TRIFASE LT. 13+13 2 vasche cm. 30,5x34x22,5h - 2 cesti cm. 28x29x10h 2 filtri e coperchi vasche - Produzione patate: 20 kg/h <ul style="list-style-type: none"> <li>Fryer threephase 13+13 lts - 2 pans cm. 30,5x34x22,5h 2 baskets cm. 28x29x10h - 2 sieves and lids for pan Production: 20 kg/h</li> <li>Friteuse dreiphasig lt. 13+13 - 2 Becken cm. 30,5x34x22,5h 2 Körbe cm. 28x29x10h - Einlegesieb und Deckel für Becken - Pommes frites: 20 kg/h</li> <li>Friteuse triphase lt. 13+13 - 2 cuves cm. 30,5x34x22,5h 2 paniers cm. 28x29x10h - 2 filtres, couvercles pour cuve Production de pommes frites: 20 kg/h</li> </ul> <b>Freidoras trifásico 13+13 lt. - 2 cubas cm. 30,5x34x22,5h - 2 cestas cm. 28x29x10h - 2 filtros y tapas para cubas Prod. patatas: 20 Kg/h cm. 80x90x28h</b>		$\begin{matrix} 23,9 \text{ kW} \\ 400\text{V}\sim\text{3N} \\ 50/60 \text{ Hz} \end{matrix}$	<b>3.403,00</b> 75 / 0,41
<b>F2/13T-98G</b> 19260850	FRIGGITRICE GAS LT. 13+13 2 vasche cm. 31,5x34,5x22,5h - 2 cesti cm. 28x29x10h 2 filtri e coperchi vasche - Prod. patate: 20 kg/h <ul style="list-style-type: none"> <li>Gas Fryer 13+13 lts - 2 pans cm. 31,5x34,5x22,5h 2 baskets cm. 28x29x10h - 2 sieves and lids for pan Production: 20 kg/h</li> <li>Gas-Friteuse lt. 13+13 - 2 Becken cm. 31,5x34,5x22,5h 2 Körbe m. 28x29x10h - Einlegesieb und Deckel für Becken - Pommes frites: 20 kg/h</li> <li>Friteuse à gaz lt. 13+13 - 2 cuves cm. 31,5x34,5x22,5h 2 paniers cm. 28x29x10h - 2 filtres, couvercles pour cuve Production de pommes frites: 20 kg/h</li> </ul> <b>Freidoras a gas 13+13 lt. - 2 cubas cm. 31,5x34,5x22,5h 2 cestas cm. 28x29x10h - 2 filtros y tapas para cubas. Prod. patatas: 20 Kg/h cm. 80x90x28h</b>		$\begin{matrix} 24 \text{ kW} \\ 20.640 \text{ kcal/h} \end{matrix}$	<b>4.162,00</b> 81 / 0,41

# IPERLOTUS 90 TOP

MOD. COD.	DESCRIZIONE/DESCRIPTION/BEZEICHNUNG/DESCRIPTION/DESCRIPCIÓN DIMENSIONI/DIMENSIONS/ABMESSUNGEN/DIMENSIONS/DIMENSIONES	POTENZA/POWER/LEISTUNG/PUISSANCE/POTENCIA VOLTAGGIO/VOLTAGE/SPANNUNG/VOLTAGE/VOLTAGE	Ø kW kcal/h	∇ kw V~ Hz	PREZZO/PRICE € PREIS/PRIX/PRECIO € KG / M <sup>3</sup>
<b>MFV-98ET</b> 09490830	Base con Forno elettrico ventilato GN 1/1 cm. 56x36x34h (non sovrapporre elementi ad induzione) • Stand with electric fan oven GN 1/1 cm. 56x36x34h (no induction top) • Unterbau mit Elektro-Heißluftofen GN 1/1 cm. 56x36x34h (nicht Induktions) • Placard avec Four à chaleur tournante électrique GN 1/1 cm. 56x36x34h (il faut pas de induction) • <b>Mueble con Horno eléctrico ventilado GN 1/1            cm. 56x36x34h (no inducción)            cm. 80x83x57h</b>		∇ 5,32 kW	400V~3N 230V~3 50/60 Hz	<b>3.302,00</b> 80 / 0,6
<b>CMF-98</b> 09490800	COPERCHIO per MFV-98E • Lid for MFV-98E • Berichterstattung für MFV-98E • Couvercle pour MFV-98E • <b>Cubertura para MFV-98E            cm. 80x82,5x2,8h</b>				<b>225,00</b> 6 / 0,02
<b>MPI-94</b> 09410403	BASE CON PORTA PER INDUZIONE • Stand with door for induction top • Unterbau für Induktions mit Tür • Placard pour induction avec porte • <b>Mueble base para inducción con puerta            cm. 40x81x57h</b>				<b>683,00</b> 22 / 0,24
<b>MPI-98</b> 09410803	<b>cm. 80x81x57h</b>				<b>789,00</b> 29 / 0,45
<b>M-94</b> 09410400	BASE NEUTRA • Stand • Offener Unterbau • Placard ouvert • <b>Mueble base            cm. 40x78,5x57h</b>				<b>468,00</b> 19 / 0,24
<b>M-96</b> 09410600	<b>cm. 60x78,5x57h</b>				<b>534,00</b> 23 / 0,35
<b>M-98</b> 09410800	<b>cm. 80x78,5x57h</b>				<b>573,00</b> 26 / 0,45
<b>M-912</b> 09411200	<b>cm. 120x78,5x57h</b>				<b>767,00</b> 38 / 0,64
<b>M-916</b> 09411600	<b>cm. 160x78,5x57h</b>				<b>1.019,00</b> 57 / 0,84
<b>PM-73/93-DX</b> 08430302	PORTA 300 DESTRA • Right door 300 / • Rechte tür 300 • Porte droite 300 / • <b>Puerta derecha 300            cm. 29,5x2,5x47,5h</b>				<b>159,00</b> 3 / 0,005
<b>PM-74/94-DX</b> 08430402	PORTA 400 DESTRA • Right door 400 / • Rechte tür 400 • Porte droite 400 / • <b>Puerta derecha 400            cm. 39,5x2,5x47,5h</b>				<b>165,00</b> 3,5 / 0,006
<b>PM-73/93-SX</b> 08430303	PORTA 300 SINISTRA • Left door 300 / • inke tür 300 • Porte gauche 300 / • <b>Puerta iziquierda 300            cm. 29,5x2,5x47,5h</b>				<b>159,00</b> 3 / 0,005
<b>PM-74/94-SX</b> 08430403	PORTA 400 SINISTRA • Left door 400 / • Linke tür 400 • Porte gauche 400 / • <b>Puerta iziquierda 400            cm. 39,5x2,5x47,5h</b>				<b>165,00</b> 3,5 / 0,006

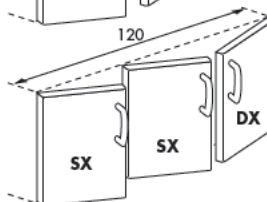
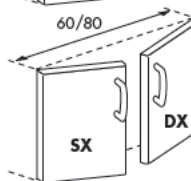
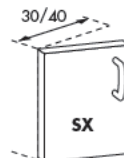
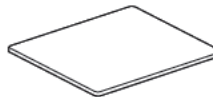

# IPERLOTUS 90

MOD. \_\_\_\_\_ DESCRIZIONE/DESCRIPTION/BEZEICHNUNG/DESCRIPTION/DESCRIPCIÓN POTENZA/POWER/LEISTUNG/PUISSANCE/POTENCIA PREZZO/PRICE €  
 COD. \_\_\_\_\_ DIMENSIONI/DIMENSIONS/ABMESSUNGEN/DIMENSIONS/DIMENSIONES VOLTAGGIO/VOLTAGE/SPANNUNG/VOLTAGE/VOLTAJE kcal/h kw V~ Hz PREIS/PRIX/PRECIO €  
 KG / M<sup>3</sup>

**C-74/94**  
08440420  
**C-76/96**  
08440620  
 CASSETTIERA 400 - N. 2 cassetti con 2 bacinelle GN 1/1 15h in plastica, guide telescopiche.  
 • Drawer set 400 - N. 2 drawers with 2 GN 1/1 15h plastic containers, telescopic guides.  
 • Schubladen - N. 2 Schubladen mit 2 GN 1/1 15h Kunststoffbehältern, Telescopeinführungen.  
 • Tiroirs pour meuble de 400 - N. 2 tiroirs avec 2 bacs en plastique GN 1/1 15h, guides télescopiques.  
**Cajonera 400 - N. 2 cajones con 2 contenedores GN 1/1 15h de plástico, guías telescópicas. cm. 39,5x59x47,5h**

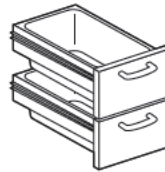

**635,00**  
18 / 0,11

**C-78/98**  
08440820  
**D-90**  
09470001  
**PT-74/94**  
08460002  
 CASSETTIERA 600 N. 2 cassetti con 2 bacinelle inox, guide telescopiche.  
 • Drawer set 600 N. 2 drawers with 2 inoxcontainers, telescopic guides.  
 • Schubladen 600 - N. 2 Schubladen mit 2 Chromnickelstahlbehältern, Telescopeinführungen.  
 • Tiroirs pour meuble de 600 N. 2 tiroirs avec 2 bacs inox, guides télescopiques.  
**Cajonera 600 - N. 2 cajones con 2 contenedores de acero inox, guías telescópicas. cm. 59,5x59x47,5h**

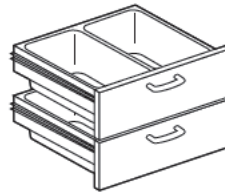

**879,00**  
22 / 0,18

**PT-78/98**  
08460012  
**531048800**  
 CASSETTIERA 800 - N. 2 cassetti con 4 bacinelle GN 1/1 15h in plastica, guide telescopiche.  
 • Drawer set 800 - N. 2 drawers with 4 GN 1/1 15h plastic containers, telescopic guides.  
 • Schubladen 800 - N. 2 Schubladen mit 4 GN 1/1 15h Kunststoffbehältern, Telescopeinführungen.  
 • Tiroirs pour meuble de 800 - N. 2 tiroirs avec 4 bacs en plastique GN 1/1 15h, guides télescopiques.  
**Cajonera 800 - N. 2 cajones con 4 contenedores GN 1/1 15h de plástico, guías telescópicas. cm. 79,5x59x47,5h**

**896,00**  
26 / 0,22

**DIVISORIO** base neutra  
 • Spacer for stand  
 • Trennwand für offener unterbau  
 • Separation pour placard ouvert  
 • Divisorio para mueble base  
**cm. 5x78x38h**

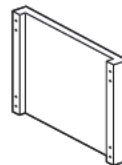

**161,00**  
2,5 / 0,015

**PORTATEGLIE VANO 400 (GN-1/1)**  
**VANO 600 (GN-2/1)** 4 ripiani int. 7 cm.  
 • Frame for plates 400 (GN-1/1) 600 (GN-2/1) - N. 4 shelves, wheel-base 7 cm.  
 • Aufhängeschienen für bleche 400 (GN-1/1) 600 (GN-2/1) - N. 4 Etagen, Abstand 7 cm.  
 • Kit porte-plaques 400 (GN-1/1) 600 (GN-2/1) - N. 4 étagères; 7 cm.  
**Portacazuelas 400 (GN-1/1) 600 (GN-2/1) - N. 4 estantes, int. 7 cm.**

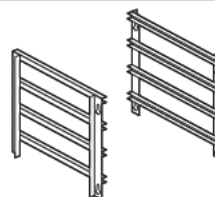

**344,00**  
2,5 / 0,01

**PORTATEGLIE VANO 800 (GN-2/1)** 4 ripiani int. 7 cm.  
 • Frame for plates 800 (GN-2/1) 4 Etagen, Abstand 7 cm.  
 • Aufhängeschienen für bleche 800 (GN-2/1) N. 4 Etagen, Abstand 7 cm.  
 • Kit porte-plaques 800 (GN-2/1) - N. 4 étagères; 7 cm.  
**Portacazuelas 800 (GN-2/1) - N. 4 estantes, int. 7 cm.**

**459,00**  
4 / 0,02









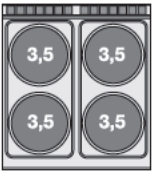

**CESTO 1/2** per F13T-G/E  
 • Basket 1/2 for F13T-G/E  
 • Korb 1/2 zur Friteuse F13T-G/E  
 • Panier 1/2 pour F13T-G/E  
**Cesta 1/2 para F13T-G/E cm. 13,5x29x9h**

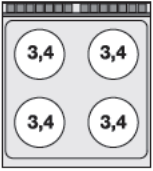

**72,00**  
0,8 / 0,02

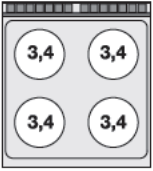

## IPERLOTUS 90

MOD. COD.	DESCRIZIONE/DESCRIPTION/BEZEICHNUNG/DESCRIPTION/DESCRIPCIÓN DIMENSIONI/DIMENSIONS/ABMESSUNGEN/DIMENSIONS/DIMENSIONES	POTENZA/POWER/LEISTUNG/PUISSANCE/POTENCIA VOLTAGGIO/VOLTAGE/SPANUNUNG/VOLTAGE/VOLTAGE	6kW kcal/h	9kW V- Hz	PREZZO/PRICE € PREIS/PRIX/PRECIO € KG / M <sup>3</sup>
<b>CF4-98ET</b> 09660830	CUCINA 4 piastre - Forno elettrico statico GN 2/1 cm. 68x73x34h • Electric range - N. 4 plates Traditional electric oven GN 2/1 cm. 68x73x34h • Elektroherd - N. 4 Kochplatten Statischer Elektro-Backofen GN 2/1 cm. 68x73x34h • Fourneau électrique - N. 4 plaques Four électrique statique GN 2/1 cm. 68x73x34h • <b>Cocina eléctrica - N. 4 planchas Horno eléctrico estático GN 2/1 cm. 68x73x34h cm. 80x90x90h</b>		20,7 kW	400V~3N 50/60 Hz	<b>4.159,00</b> 142 / 0,88
					
<b>CFV4-98ET</b> 09660835	CUCINA 4 piastre - Forno elettrico ventilato GN 1/1 cm. 68x36x34h • Electric range - N. 4 plates - electric fan oven GN 1/1 cm. 68x36x34h • Elektroherd - N. 4 Kochplatten - Elektro-Heißluftofen GN 1/1 cm. 68x36x34h • Fourneau électrique - N. 4 plaques Four à chaleur tournante électrique GN 1/1 cm. 68x36x34h • <b>Cocina eléctrica - N. 4 planchas - Horno eléctrico ventilado GN 1/1 cm. 68x36x34h cm. 80x90x90h</b>		19,32 kW	400V~3N 50/60 Hz	<b>4.516,00</b> 142 / 0,88
					
<b>CFQ4-98ET</b> 09660831	CUCINA 4 piastre quadre - Forno elettrico statico GN 2/1 cm. 68x73x34h • Electric range - N. 4 square plates Traditional electric oven GN 2/1 cm. 68x73x34h • Elektroherd - N. 4 quadratischen Platten - Statischer Elektro-Backofen GN 2/1 cm. 68x73x34h • Fourneau électrique - N. 4 plaques carrés - Four électrique statique GN 2/1 cm. 68x73x34h • <b>Cocina eléctrica - N. 4 planchas cuadradas Horno eléctrico estático GN 2/1 cm. 68x73x34h cm. 80x90x90h</b>		22,7 kW	400V~3N 50/60 Hz	<b>5.027,00</b> 150 / 0,88
					
<b>CFVQ4-98ET</b> 09660836	CUCINA 4 piastre quadre - Forno elettrico ventilato GN 1/1 cm. 68x36x34h • Electric range - N. 4 square plates - electric fan oven GN 1/1 cm. 68x36x34h • Elektroherd - N. 4 quadratischen Platten - Elektro-Heißluftofen GN 1/1 cm. 68x36x34h • Fourneau électrique - N. 4 plaques carrés - Four à chaleur tournante électrique GN 1/1 cm. 68x36x34h • <b>Cocina eléctrica - N. 4 planchas cuadradas Horno eléctrico ventilado GN 1/1 cm. 68x36x34h cm. 80x90x90h</b>		21,32 kW	400V~3N 50/60 Hz	<b>5.384,00</b> 150 / 0,88
					
<b>CFC4-98ET</b> 09660832	CUCINA 4 piastre vetroceramica cm. 75x75 - Forno elettrico statico GN 2/1 cm. 68x73x34h • Electric range N. 4 plates ceramic glass cm. 75x75 - traditional electric oven GN 2/1 cm. 68x73x34h • Elektroherd N. 4 Ceran-Kochplatten cm. 75x75 - Statischer Elektro-Backofen GN 2/1 cm. 68x73x34h • Fourneau électrique N. 4 plaques vitroceramique cm. 75x75 - Four électrique statique GN 2/1 cm. 68x73x34h • <b>Cocina eléctrica N. 4 planchas vitrocerámica cm. 75x75 - Horno eléctrico estático GN 2/1 cm. 68x73x34h cm. 80x90x90h</b>		20,3 kW	400V~3N 50/60 Hz	<b>5.558,00</b> 130 / 0,88
					
<b>CFVC4-98ET</b> 09660837	CUCINA 4 piastre vetroceramica cm. 75 x75 - Forno elettrico ventilato GN 1/1 cm. 68x36x34h • Electric range N. 4 plates ceramic glass cm. 75 x75 - electric fan oven GN 1/1 cm. 68x36x34h • Elektroherd N. 4 Ceran-Kochplatten cm. 75 x75 - Elektro-Heißluftofen GN 1/1 cm. 68x36x34h • Fourneau électrique N. 4 plaques vitroceramique cm. 75 x75 - Four à chaleur tournante électrique GN 1/1 cm. 68x36x34h • <b>Cocina eléctrica N. 4 planchas vitrocerámica cm. 75 x75 - Horno eléctrico ventilado GN 1/1 cm. 68x36x34h cm. 80x90x90h</b>		18,92 kW	400V~3N 50/60 Hz	<b>5.914,00</b> 130 / 0,88
					

# IPERLOTUS 90

MOD. \_\_\_\_\_ DESCRIZIONE/DESCRIPTION/BEZEICHNUNG/DESCRIPTION/DESCRIPCIÓN POTENZA/POWER/LEISTUNG/PUISSANCE/POTENCIA PREZZO/PRICE €  
 COD. \_\_\_\_\_ DIMENSIONI/DIMENSIONS/ABMESSUNGEN/DIMENSIONS/DIMENSIONES VOLTAGGIO/VOLTAGE/SPANNUNG/VOLTAGE/VOLTAJE kcal/h kw V- Hz PREIS/PRX/PRECIO €  
 KG / M<sup>3</sup>

**CF4-98G** CUCINA 4 fuochi - Forno a gas statico  
 09680850 GN 2/1 cm. 68x73x34h  
 • Gas Range - N. 4 burners Traditional gas-oven GN 2/1 cm. 68x73x34h  
 • Gasherd - N. 4 Kochstellen Statischer Gas-Backofen GN 2/1 cm. 68x73x34h  
 • Cuisiniere gaz - N. 4 feuxvifs Four à gaz statique GN 2/1 cm. 68x73x34h  
**Cocina a gas - N. 4 quemadores Horno a gas estático GN 2/1 cm. 68x73x34h cm. 80x90x90h**



36,5 kW 3.884,00  
 31.390 kcal/h 166 / 0,88

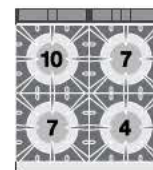

**CF4-98GE** CUCINA 4 fuochi - Forno elettrico statico GN 2/1 cm. 68x73x34h  
 09690860 • Gas Range - N. 4 burners - traditional electric oven GN 2/1 cm. 68x73x34h  
 • Gasherd - N. 4 Kochstellen Statischer Elektro-Backofen GN 2/1 cm. 68x73x34h  
 • Cuisiniere gaz - N. 4 feuxvifs Four électrique statique GN 2/1 cm. 68x73x34h  
**Cocina a gas - N. 4 quemadores Horno eléctrico estático GN 2/1 cm. 68x73x34h cm. 80x90x90h**

28 kW 3.961,00  
 24.080 kcal/h 164 / 0,88

6,7 kW  
 400V~3N  
 50/60 Hz

**CFV4-98GE** CUCINA 4 fuochi - Forno elettrico ventilato GN 1/1 cm. 68x36x34h  
 09690865 • Gas Range - N. 4 burners - electric fan oven GN 1/1 cm. 68x36x34h  
 • Gasherd - N. 4 Kochstellen Elektro-Heißluftofen GN 1/1 cm. 68x36x34h  
 • Cuisiniere gaz - N. 4 feuxvifs Four à chaleur tournante électrique GN 1/1 cm. 68x36x34h  
**Cocina a gas - N. 4 quemadores Horno eléctrico ventilado GN 1/1 cm. 68x36x34h cm. 80x90x90h**

28 kW 4.317,00  
 24.080 kcal/h 164 / 0,88

5,32 kW  
 400V~3N  
 230V~3  
 50/60 Hz

**CF4A-98G** CUCINA ACQUA 4 fuochi Forno a gas statico  
 09750850 GN 2/1 cm. 68x73x34h - Rubinetto carico acqua, sfiatore  
 • Water range - N. 4 burners Traditional gas-oven GN 2/1 cm. 68x73x34h - Water loading tap + overflow device  
 • Wasser herd - N. 4 Kochstellen Statischer Gas-Backofen GN 2/1 cm. 68x73x34h - Wasserlauf-Hahn + Überlauf-Vorrichtung  
 • Cuisiniere l'eau - N. 4 feuxvifs Four à gaz statique GN 2/1 cm. 68x73x34h - Robinet d'arrivée d'eau trop plein  
**Cocina a agua - N. 4 quemadores Horno a gas estático cm. 68x73x34h - Grifo carga agua + vertedero cm. 80x90x90h**



36,5 kW 5.196,00  
 31.390 kcal/h 166 / 0,88

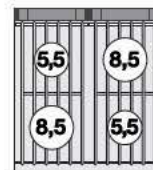

**CF6-912ETV** CUCINA 6 piastre - Forno elettrico statico  
 09661230 GN 2/1 cm. 68x73x34h - Vano neutro con porta  
 • Electric range - N. 6 plates Traditional electric oven GN 2/1 cm. 68x73x34h Neutral cabinet with door  
 • Elektroherd - N. 6 Kochplatten Statischer Elektro-Backofen GN 2/1 cm. 68x73x34h Neutrales Schrankelement mit Tür  
 • Fourneau électrique - N. 6 plaques Four électrique statique GN 2/1 cm. 68x73x34h Element neutre avec porte  
**Cocina eléctrica - N. 6 planchas Horno eléctrico estático GN 2/1 cm. 68x73x34h Armario neutro con puerta cm. 120x90x90h**



27,7 kW 5.478,00  
 400V~3N 200 / 1,31  
 50/60 Hz

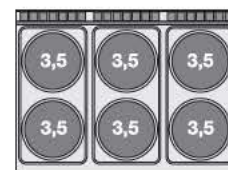

**CFV6-912ETV** CUCINA 6 piastre - Forno elettrico ventilato  
 09661235 GN 1/1 cm. 68x36x34h - Vano neutro con porta  
 • Electric range - N. 6 plates electric fan oven GN 1/1 cm. 68x36x34h Neutral cabinet with door  
 • Elektroherd - N. 6 Kochplatten Elektro-Heißluftofen GN 1/1 cm. 68x36x34h Neutrales Schrankelement mit Tür  
 • Fourneau électrique - N. 6 plaques Four à chaleur tournante électrique GN 1/1 cm. 68x36x34h Element neutre avec porte  
**Cocina eléctrica - N. 6 planchas Horno eléctrico ventilado GN 1/1 cm. 68x36x34h Armario neutro con puerta cm. 120x90x90h**

26,32 kW 5.834,00  
 400V~3N 200 / 1,31  
 50/60 Hz

# IPERLOTUS 90

<b>MOD.</b> COD.	<b>DESCRIZIONE/DESCRIPTION/BEZEICHNUNG/DESCRIPTION/DESCRIPCIÓN</b> <b>DIMENSIONI/DIMENSIONS/ABMESSUNGEN/DIMENSIONS/DIMENSIONES</b>	<b>POTENZA/POWER/LEISTUNG/PUISSANCE/POTENCIA</b> <b>VOLTAGGIO/VOLTAGE/SPANNUNG/VOLTAGE/VOLTAJE</b>	$\frac{\text{kW}}{\text{kcal/h}}$ $\frac{\text{V}}{\text{Hz}}$	<b>PREZZO/PRICE</b> <b>PREIS/PRIZ/PRECIO</b> € KG / M <sup>3</sup>
---------------------	---	---	---	---

**CFQ6-912ETV** 09661231 CUCINA 6 piastre quadre - Forno elettrico statico GN 2/1 cm. 68x73x34h - Vano neutro con porta

- Electric range - N. 6 square plates Traditional electric oven GN 2/1 cm. 68x73x34h Neutral cabinet with door
- Elektroherd - N. 6 quadratischen Platten Statischer Elektro-Backofen GN 2/1 cm. 68x73x34h Neutrales Schrankelement mit Tür
- Fourneau électrique - N. 6 plaques carrés Four électrique statique GN 2/1 cm. 68x73x34h Element neutre avec porte
- **Cocina eléctrica - N. 6 planchas cuadradas Horno eléctrico estático GN 2/1 cm. 68x73x34h Armario neutro con puerta cm. 120x90x90h**



$\frac{30,7 \text{ kW}}{400\text{V}\sim 3\text{N}}$   $\frac{6.927,00}{212 / 1,31}$   
50/60 Hz



**CFVQ6-912ETV** 09661236 CUCINA 6 piastre quadre - Forno elettrico ventilato GN 1/1 cm. 68x36x34h - Vano neutro con porta

- Electric range - N. 6 square plates electric fan oven GN 1/1 cm. 68x36x34h Neutral cabinet with door
- Elektroherd - N. 6 quadratischen Platten Elektro-Heißluftofen GN 1/1 cm. 68x36x34h Neutrales Schrankelement mit Tür
- Fourneau électrique - N. 6 plaques carrés Four à chaleur tournante électrique GN 1/1 cm. 68x36x34h Element neutre avec porte
- **Cocina eléctrica - N. 6 planchas cuadradas Horno eléctrico ventilado GN 1/1 cm. 68x36x34h Armario neutro con puerta cm. 120x90x90h**

$\frac{29,32 \text{ kW}}{400\text{V}\sim 3\text{N}}$   $\frac{7.283,00}{212 / 1,31}$   
50/60 Hz

**CF6-912ET** 09661232 CUCINA 6 piastre Forno elettrico statico GN 3/1 cm. 108x73x34h

- Electric Range - N. 6 plates Traditional electric oven GN 3/1 cm. 108x73x34h
- Elektroherd - N. 6 Kochplatten Statischer Elektro-Backofen GN 3/1 cm. 108x73x34h
- Fourneau électrique - N. 6 plaques Four électrique statique GN 3/1 cm. 108x73x34h
- **Cocina eléctrica - N. 6 planchas Horno eléctrico estático GN 3/1 cm. 108x73x34h cm. 120x90x90h**



$\frac{30,2 \text{ kW}}{400\text{V}\sim 3\text{N}}$   $\frac{5.936,00}{206 / 1,31}$   
50/60 Hz



**CFQ6-912ET** 09661233 CUCINA 6 piastre quadre Forno elettrico statico GN 3/1 cm. 108x73x34h

- Electric Range - N. 6 square plates Traditional electric oven GN 3/1 cm. 108x73x34h
- Elektroherd - N. 6 quadratischen Platten Statischer Elektro-Backofen GN 3/1 cm. 108x73x34h
- Fourneau électrique - N. 6 plaques carrés Four électrique statique GN 3/1 cm. 108x73x34h
- **Cocina eléctrica - N. 6 planchas cuadradas Horno eléctrico estático GN 3/1 cm. 108x73x34h cm. 120x90x90h**



$\frac{33,2 \text{ kW}}{400\text{V}\sim 3\text{N}}$   $\frac{7.378,00}{218 / 1,31}$   
50/60 Hz



# IPERLOTUS 90

MOD. \_\_\_\_\_ DESCRIZIONE / DESCRIPTION / BEZEICHNUNG / DESCRIPTION / DESCRIPCIÓN POTENZA / POWER / LEISTUNG / PUISSANCE / POTENCIA PREZZO / PRICE / ⚡  
 COD. \_\_\_\_\_ DIMENSIONI / DIMENSIONS / ABMESSUNGEN / DIMENSIONS / DIMENSIONES VOLTAGGIO / VOLTAGE / SPANNUNG / VOLTAGE / VOLTAJE kcal/h kw / PREIS / PRD. / PRECIO €  
 KG / M<sup>3</sup>

**CF6-912GV** CUCINA 6 fuochi Forno a gas statico  
 09681251 GN 2/1 cm. 68x73x34h Vano neutro con porta  
 • Gas Range - N. 6 burners Traditional gas-oven  
 GN 2/1 cm. 68x73x34h Neutral cabinet with door  
 • Gasherd - N. 6 Kochstellen - Statischer Gas-Backofen  
 GN 2/1 cm. 68x73x34h - Neutrales Schrankelement mit Tür  
 • Cuisiniere Gaz - N. 6 feuxvifs Four à gaz statique  
 GN 2/1 cm. 68x73x34h Élément neutre avec porte  
 • **Cocina a gas - N. 6 quemadores Horno a gas estático cm. 68x73x34h - Armario neutro con puerta cm. 120x90x90h**



⚡ 53,5 kW 5.263,00  
 46.010 kcal/h 230 / 1,31

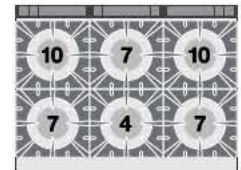

**CF6-912GEV** CUCINA 6 fuochi - Forno elettrico statico  
 09691261 GN 2/1 cm. 68x73x34h - Vano neutro con porta  
 • Gas Range - N. 6 burners - traditional electric oven  
 GN 2/1 cm. 68x73x34h Neutral cabinet with door  
 • Gasherd - N. 6 Kochstellen Statischer Elektro-Backofen  
 GN 2/1 cm. 68x73x34h Neutrales Schrankelement mit Tür  
 • Cuisiniere gaz - N. 6 feuxvifs Four électrique statique  
 GN 2/1 cm. 68x73x34h Element neutre avec porte  
 • **Cocina a gas - N. 6 quemadores Horno eléctrico estático GN 2/1 cm. 68x73x34h Armario neutro con puerta cm. 120x90x90h**

⚡ 45 kW 5.357,00  
 38.700 kcal/h 228 / 1,31

⚡ 6,7 kW  
 400V~3N  
 50/60 Hz

**CFV6-912GEV** CUCINA 6 fuochi - Forno elettrico ventilato  
 09691266 GN 1/1 cm. 68x36x34h - Vano neutro con porta  
 • Gas Range - N. 6 burners - lectric fan oven  
 GN 1/1 cm. 68x36x34h Neutral cabinet with door  
 • Gasherd - N. 6 Kochstellen Elektro-Heißluftofen  
 GN 1/1 cm. 68x36x34h Neutrales Schrankelement mit Tür  
 • Cuisiniere gaz - N. 6 feuxvifs Four à chaleur tournante électrique GN 1/1 cm. 68x36x34h Element neutre avec porte  
 • **Cocina a gas - N. 6 quemadores Horno eléctrico ventilado GN 1/1 cm. 68x36x34h Armario neutro con puerta cm. 120x90x90h**

⚡ 45 kW 5.717,00  
 38.700 kcal/h 228 / 1,31

⚡ 5,32 kW  
 400V~3N  
 230V~3  
 50/60 Hz

**CFA6-912GV** CUCINA ACQUA 6 fuochi Forno a gas statico  
 09751251 GN 2/1 cm. 68x73x34h Vano neutro con porta - Rubinetto carico acqua, sfioratore  
 • Water range - N. 6 burners - Traditional gas-oven  
 GN 2/1 cm. 68x73x34h - Neutral cabinet with door - Water loading tap + overflow device  
 • Wasser herd - N. 6 Kochstellen - Statischer Gas-Backofen  
 GN 2/1 cm. 68x73x34h - Neutrales Schrankelement mit Tür - Wasserlauf-Hahn + Überlauf-Vorrichtung  
 • Cuisiniere l'eau - N. 6 feuxvifs Four à gaz statique  
 GN 2/1 - cm. 68x73x34h - Element neutre avec porte - Robinet d'arrivée d'eau trop plein  
 • **Cocina a agua N. 6 quemadores Horno a gas estático cm. 68x73x34h - Armario neutro con puerta - Grifo carga agua + vertedero cm. 120x90x90h**



⚡ 50,5 kW 6.782,00  
 43.430 kcal/h 230 / 1,31

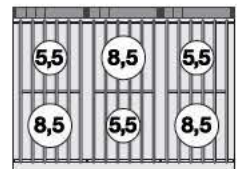

**CF6-912G** CUCINA 6 fuochi Forno a gas statico  
 09681250 GN 3/1 cm. 108x73x34h  
 • Gas Range - N. 6 burners Traditional gas-oven  
 GN 3/1 cm. 108x73x34h  
 • Gasherd - N. 6 Kochstellen Statischer Gas-Backofen  
 GN 3/1 cm. 108x73x34h  
 • Cuisiniere gaz - N. 6 feuxvifs Four à gaz statique  
 GN 3/1 cm. 108x73x34h  
 • **Cocina a gas - N. 6 quemadores Horno a gas estático GN 3/1 cm. 108x73x34h cm. 120x90x90h**



⚡ 58 kW 5.660,00  
 49.820 kcal/h 236 / 1,31

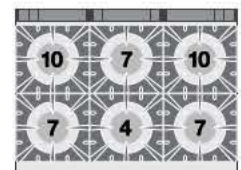

**CF6-912GE** CUCINA 6 fuochi Forno elettrico statico GN 3/1 cm. 108x73x34h  
 09691260 • Gas Range - N. 6 burners Traditional electric oven GN 3/1 cm. 108x73x34h  
 • Gasherd - N. 6 Kochstellen Statischer Elektro-Backofen GN 3/1 cm. 108x73x34h  
 • Cuisiniere gaz - N. 6 feuxvifs Four électrique statique GN 3/1 cm. 108x73x34h  
 • **Cocina a gas - N. 6 quemadores Horno eléctrico estático GN 3/1 cm. 108x73x34h cm. 120x90x90h**

⚡ 45 kW 5.765,00  
 38.700 kcal/h 230 / 1,31

⚡ 9,2 kW  
 400V~3N  
 50/60 Hz

## IPERLOTUS 90

MOD.  
COD.DESCRIZIONE/DESCRIPTION/BEZEICHNUNG/DESCRIPTION/DESCRIPCIÓN  
DIMENSIONI/DIMENSIONS/ABMESSUNGEN/DIMENSIONS/DIMENSIONESPOTENZA/POWER/LEISTUNG/PUISSANCE/POTENCIA  
VOLTAGGIO/VOLTAGE/SPANNUNG/VOLTAGE/VOLTAJEkcal/h  
kcal/h  
V  
HzPREZZO/PRICE  
PREIS/PRIX/PRECIO €  
KG / M<sup>3</sup>CF8-916ET  
09661632

- CUCINA 8 piastre - 2 Forni elettrici statici  
GN 2/1 cm. 68x73x34h
- Electric range - N. 8 plates - 2 Traditional electric oven GN 2/1 cm. 68x73x34h
  - Elektroherd - N. 8 Kochplatten - 2 Statischer Elektro-Backofen GN 2/1 cm. 68x73x34h
  - Fourneau électrique - N. 8 plaques - 2 Four électrique statique GN 2/1 cm. 68x73x34h
  - **Cocina eléctrica - N. 8 planchas - 2 Horno eléctrico estático GN 2/1 cm. 68x73x34h cm. 160x90x90h**



41,4 kW  
400V~3N  
50/60 Hz

**7.868,00**  
246 / 1,86

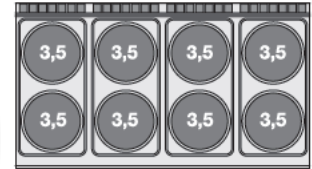
CFQ8-916ET  
09661633

- CUCINA 8 piastre quadre- 2 Forni elettrici statici  
GN 2/1 cm. 68x73x34h
- Electric range - N. 8 square plates - 2 Traditional electric oven GN 2/1 cm. 68x73x34h
  - Elektroherd - N. 8 quadratischen Platte - 2 Statischer Elektro-Backofen GN 2/1 cm. 68x73x34h
  - Fourneau électrique - N. 8 plaques carrés - 2 Four électrique statique GN 2/1 cm. 68x73x34h
  - **Cocina eléctrica - N. 8 planchas cuadradas - 2 Horno eléctrico estático GN 2/1 cm. 68x73x34h cm. 160x90x90h**



45,4 kW  
400V~3N  
50/60 Hz

**9.278,00**  
266 / 1,86

CF8-916G  
09681650

- CUCINA 8 fuochi - 2 Forni gas statici  
GN 2/1 cm. 68x73x34h
- Gas Range - N. 8 burners - 2 Traditional gas-oven GN 2/1 cm. 68x73x34h
  - Gasherd - N. 8 Kochstellen - 2 Statischer Gas-Backofen GN 2/1 cm. 68x73x34h
  - Cuisiniere gaz - N. 8 feux- 2 Four à gaz statique GN 2/1 cm. 68x73x34h
  - **Cocina a gas - N. 8 quemadores - 2 Horno a gas estático GN 2/1 cm. 68x73x34h cm. 160x90x90h**



73 kW  
62.780 kcal/h

**7.740,00**  
318 / 1,86

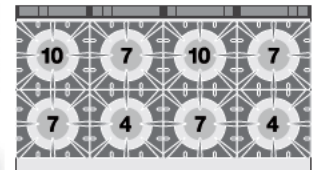
CF8-916GE  
09691660

- CUCINA 8 fuochi - 2 Forni elettrici statici  
GN 2/1 cm. 68x73x34h
- Gas Range - N. 8 burners - 2 Traditional electric oven GN 2/1 cm. 68x73x34h
  - Gasherd - N. 8 Kochstellen - 2 Statischer Elektro-Backofen GN 2/1 cm. 68x73x34h
  - Cuisiniere gaz - N. 8 feux- 2 Four électrique statique GN 2/1 cm. 68x73x34h
  - **Cocina a gas - N. 8 quemadores - 2 Horno eléctrico estático GN 2/1 cm. 68x73x34h cm. 160x90x90h**

56 kW  
48.160 kcal/h

**7.912,00**  
312 / 1,86

13,4 kW  
400V~3N  
50/60 Hz

# IPERLOTUS 90

MOD. \_\_\_\_\_ DESCRIZIONE/DESCRIPTION/BEZEICHNUNG/DESCRIPTION/DESCRIPCIÓN POTENZA/POWER/LEISTUNG/PUISSANCE/POTENCIA ⚡ kW ⚡ kw PREZZO/PRICE €  
 COD. \_\_\_\_\_ DIMENSIONI/DIMENSIONS/ABMESSUNGEN/DIMENSIONS/DIMENSIONES VOLTAGGIO/VOLTAGE/SPANNUNG/VOLTAGE/VOLTAJE kcal/h kcal/h V~ PREIS/PRIX/PRECIO €  
 KG / M<sup>3</sup>

**CF8-916ETV** CUCINA 8 piastre Forno elettrico statico GN 3/1  
 09661630 cm. 108x73x34h - Vano neutro con porta  
 • Electric Range - N. 8 plates Traditional electric oven GN 3/1 cm. 108x73x34h - Neutral cabinet with door  
 • Elektroherd - N. 8 Kochplatten Statischer Elektro-Backofen GN 3/1 cm. 108x73x34h - Neutrales Schrankelement mit Tür  
 • Fourneau électrique - N. 8 plaques Four électrique statique GN 3/1 cm. 108x73x34h - Elément neutre avec porte  
 • **Cocina eléctrica - N. 8 planchas Horno eléctrico estático GN 3/1 cm. 108x73x34h - Armario neutro con puerta cm. 160x90x90h**



⚡ 37,2 kW **7.410,00**  
 400V~3N 234 / 1,86  
 50/60 Hz

**CFQ8-916ETV** CUCINA 8 piastre quadre Forno elettrico  
 09661631 statico GN 3/1 cm. 108x73x34h -  
 Vano neutro con porta  
 • Electric Range - N. 8 square plates - Traditional electric oven GN 3/1 cm. 108x73x34h - Neutral cabinet with door  
 • Elektroherd - N. 8 quadratischen Platten - Statischer Elektro-Backofen GN 3/1 cm. 108x73x34h - Neutrales Schrankelement mit Tür  
 • Fourneau électrique - N. 8 plaques carrés - Four électrique statique GN 3/1 cm. 108x73x34h - Elément neutre avec porte  
 • **Cocina eléctrica - N. 8 planchas cuadradas - Horno eléctrico estático GN 3/1 cm. 108x73x34h - Armario neutro con puerta cm. 160x90x90h**



⚡ 41,2 kW **8.813,00**  
 400V~3N 254 / 1,86  
 50/60 Hz

**CF8-916GV** CUCINA 8 fuochi Forno a gas statico GN 3/1  
 09681651 cm. 108x73x34h - Vano neutro con porta  
 • Gas Range - N. 8 burners Traditional gas-oven GN 3/1 cm. 108x73x34h - Neutral cabinet with door  
 • Gasherd - N. 8 Kochstellen Statischer Gas-Backofen GN 3/1 cm. 108x73x34h - Neutrales Schrankelement mit Tür  
 • Cuisinière gaz - N. 8 feuxvifs Four à gaz statique GN 3/1 cm. 108x73x34h - Elément neutre avec porte  
 • **Cocina a gas - N. 8 quemadores Horno a gas estático GN 3/1 cm. 108x73x34h - Armario neutro con puerta equipado cm. 160x90x90h**











⚡ 69 kW **7.448,00**  
 59.270 kcal/h 306 / 1,86

**CF8-916GEV** CUCINA 8 fuochi Forno elettrico statico GN 3/1  
 09691661 cm. 108x73x34h - vano neutro con porta  
 • Gas Range - N. 8 burners Traditional electric oven GN 3/1 cm. 108x73x34h - neutral cabinet with door  
 • Gasherd - N. 8 Kochstellen Statischer Elektro-Backofen GN 3/1 cm. 108x73x34h - Neutrales Schrankelement mit Tür  
 • Cuisinière gaz - N. 8 feuxvifs Four électrique statique GN 3/1 cm. 108x73x34h - élément neutre avec porte  
 • **Cocina a gas - N. 8 quemadores Horno eléctrico estático GN 3/1 cm. 108x73x34h - armario neutro con puerta cm. 160x90x90h**





⚡ 56 kW **7.555,00**  
 48.160 kcal/h 299 / 1,86

⚡ 9,2 kW  
 400V~3N  
 50/60 Hz

# IPERLOTUS 90

MOD. / COD.	DESCRIZIONE / DESCRIPTION / BEZEICHNUNG / DESCRIPTION / DESCRIPCIÓN / DIMENSIONI / DIMENSIONS / ABMESSUNGEN / DIMENSIONS / DIMENSIONES	POTENZA / POWER / LEISTUNG / PUISSANCE / POTENCIA / VOLTAGGIO / VOLTAGE / SPANNUNG / VOLTAGE / VOLTAJE	$\frac{kW}{kcal/h}$ / $\frac{kW}{V}$ / Hz PREZZO / PRICE € / PREIS / PRIX / PRECIO € / KG / M <sup>3</sup>
PC-94ET 09030430	PIANO COTTURA TRIFASE SU MOBILE A GIORNO - N. 2 piastre • Boiling unit threephase on open cabinet - N. 2 plates • Kochplatte dreiphasig mit offenem Unterbau - N. 2 Kochplatten • Rechaud électriques sur armoire ouvert - N. 2 plaques • <b>Sobre de cocción trifásico sobre mueble abierto - N. 2 planchas cm. 40x90x90h</b>	$\frac{7,0 kW}{400V \sim 2N}$ $\frac{230V \sim 3}{230V \sim}$ 50/60 Hz	<b>1.439,00</b> 53 / 0,46 
PC-98ET 09030830	PIANO COTTURA TRIFASE SU MOBILE A GIORNO - N. 4 piastre • Threephase boiling unit on open cabinet - N. 4 plates • Kochplatte dreiphasig mit offenem Unterbau N. 4 Kochplatten • Rechaud triphase sur armoire ouvert - N. 4 plaques • <b>Sobre de cocción trifásico sobre mueble abierto N. 4 planchas cm. 80x90x90h</b>	$\frac{14,0 kW}{400V \sim 3N}$ 50/60 Hz	<b>2.667,00</b> 86 / 0,88 
PC-912ET 09031230	PIANO COTTURA TRIFASE SU MOBILE A GIORNO - N. 6 piastre • Threephase boiling unit on open cabinet - N. 6 plates • Kochplatte dreiphasig mit offenem Unterbau N. 6 Kochplatten • Rechaud triphase sur armoire ouvert - N. 6 plaques • <b>Sobre de cocción trifásico sobre mueble abierto N. 6 planchas cm. 120x90x90h</b>	$\frac{21,0 kW}{400V \sim 3N}$ 50/60 Hz	<b>3.636,00</b> 114 / 1,31 
PC-916ET 09031630	PIANO COTTURA TRIFASE SU MOBILE A GIORNO - N. 8 piastre • Threephase boiling unit on open cabinet - N. 8 plates • Kochplatte dreiphasig mit offenem Unterbau N. 8 Kochplatten • Rechaud triphase sur armoire ouvert - N. 8 plaques • <b>Sobre de cocción trifásico sobre mueble abierto N. 8 planchas cm. 160x90x90h</b>	$\frac{28 kW}{400V \sim 3N}$ 50/60 Hz	<b>4.580,00</b> 154 / 1,86 
PCQ-94ET 09030431	PIANO COTTURA TRIFASE SU MOBILE A GIORNO - N. 2 piastre quadre • Boiling unit threephase on open cabinet - N. 2 square plates • Kochplatte dreiphasig mit offenem Unterbau N. 2 quadratischen Platten • Rechaud électriques sur armoire ouvert - N. 2 plaques carrés • <b>Sobre de cocción trifásico sobre mueble abierto N. 2 planchas cuadradas cm. 40x90x90h</b>	$\frac{8,0 kW}{400V \sim 2N}$ $\frac{230V \sim 3}{230V \sim}$ 50/60 Hz	<b>1.894,00</b> 57 / 0,46 
PCQ-98ET 09030831	PIANO COTTURA TRIFASE SU MOBILE A GIORNO - N. 4 piastre quadre • Boiling unit threephase on open cabinet - N. 4 square plates • Kochplatte dreiphasig mit offenem Unterbau N. 4 quadratischen Platten • Rechaud électriques sur armoire ouvert - N. 4 plaques carrés • <b>Sobre de cocción trifásico sobre mueble abierto N. 4 planchas cuadradas cm. 80x90x90h</b>	$\frac{16,0 kW}{400V \sim 3N}$ 50/60 Hz	<b>3.424,00</b> 94 / 0,88 
PCQ-912ET 09031231	PIANO COTTURA TRIFASE SU MOBILE A GIORNO - N. 6 piastre quadre • Boiling unit threephase on open cabinet - N. 6 square plates • Kochplatte dreiphasig mit offenem Unterbau N. 6 quadratischen Platten • Rechaud électriques sur armoire ouvert - nN. 6 plaques carrés • <b>Sobre de cocción trifásico sobre mueble abierto N. 6 planchas cuadradas cm. 120x90x90h</b>	$\frac{24,0 kW}{400V \sim 3N}$ 50/60 Hz	<b>4.716,00</b> 129 / 1,31 
PCQ-916ET 09031631	PIANO COTTURA TRIFASE SU MOBILE A GIORNO - N. 8 piastre quadre • Boiling unit threephase on open cabinet - N. 8 square plates • Kochplatte dreiphasig mit offenem Unterbau N. 8 quadratischen Platten • Rechaud électriques sur armoire ouvert - N. 8 plaques carrés • <b>Sobre de cocción trifásico sobre mueble abierto N. 8 planchas cuadradas cm. 160x90x90h</b>	$\frac{32 kW}{400V \sim 3N}$ 50/60 Hz	<b>6.099,00</b> 170 / 1,86 

# IPERLOTUS 90

MOD. / COD.	DESCRIZIONE / DESCRIPTION / BEZEICHNUNG / DESCRIPTION / DESCRIPCIÓN / DIMENSIONI / DIMENSIONS / ABMESSUNGEN / DIMENSIONS / DIMENSIONES	POTENZA / POWER / LEISTUNG / PUISSANCE / POTENCIA / VOLTAGGIO / VOLTAGE / SPANNUNG / VOLTAGE / VOLTAJE	$\frac{kW}{kcal/h}$ / $\frac{kw}{V-}$ / $\frac{Hz}{}$	PREZZO / PRICE / PREIS / PRIX / PRECIO / KG / M <sup>3</sup> / €
<b>PCC-94ET</b> 09030432	<b>PIANO COTTURA VETROCERAMICA TRIFASE</b> su mobile a giorno - N. 2 zone - vetro cm.35x77 • Ceramic glass boiling unit on open cabinet - n. 2 zones - glass cm.35x77 • Ceran-Kochplatte dreiphasig mit offenem Unterbau - 2 zonen - Glas 35x77 cm • Plan de cuisson à vitroceramique triphasé sur armoire ouvert N. 2 zones - Verre cm.35x77 • <b>Sobre de cocción trifásico vitrocerámica sobre mueble abierto - 2 zonas - vidrio cm.35x77 cm. 40x90x90h</b>		$\frac{6,8}{400V\sim 2N}$ $\frac{230V\sim 3}{230V\sim}$ $\frac{50/60}{Hz}$	<b>2.382,00</b> 48 / 0,46
<b>PCC-98ET</b> 09030832	<b>PIANO COTTURA VETROCERAMICA TRIFASE</b> su mobile a giorno - N. 4 zone - vetro cm. 75x77 • Ceramic glass boiling unit on open cabinet - n. 4 zones - glass cm. 75 x77 • Ceran-Kochplatte dreiphasig mit offenem Unterbau - 4 zonen - Glas 75x77 cm • Plan de cuisson à vitroceramique triphasé sur armoire ouvert N. 4 zones - Verre cm 75x77 • <b>Sobre de cocción trifásico vitrocerámica sobre mueble abierto - 4 zonas - vidrio cm. 75 x77 cm. 80x90x90h</b>		$\frac{13,6}{400V\sim 3N}$ $\frac{230V\sim 3}{50/60}$	<b>3.837,00</b> 74 / 0,88
<b>PCI-94ET</b> 09030433	<b>PIANO COTTURA INDUZIONE TRIFASE -</b> N. 2 zone - Vetro cm.35x77 • Three-phase induction cooking - 2 zones - glass cm.35x77 • Induktions-Kochplatte dreiphasig - 2 zonen - Glas 35x77 cm • Plan de cuisson à induction triphasé N. 2 zones - Verre cm.35x77 • <b>Encimera inducción trifásica - 2 zonas - Vidrio cm.35x77 cm. 40x90x90h</b>		$\frac{10}{400V\sim 3}$ $\frac{50/60}{Hz}$	<b>7.261,00</b> 57 / 0,46
<b>PCI-94ETD</b> 09030438	Comandi digitali • Digital controls / • Digitale Steuerungen • Commandes numériques / • <b>Controles digitales</b>			<b>7.766,00</b> 57 / 0,46
<b>PCIW-94ET</b> 09030434	<b>PIANO COTTURA INDUZIONE TRIFASE "WOK" -</b> N. 1 zona - Vetro Ø 30 cm. • Three-phase induction cooking "WOK" - 1 zone - glass Ø 30 cm • Induktions-Kochplatte "WOK" dreiphasig - 1 zonen - Glas Ø 30 cm • Plan de cuisson à induction "WOK" triphasé N. 1 zone - Verre cm Ø 30 • <b>Encimera inducción "WOK" trifásica - 1 zona - Vidrio Ø 30 cm cm. 40x90x90h</b>		$\frac{5}{400V\sim 3}$ $\frac{50/60}{Hz}$	<b>5.451,00</b> 53 / 0,46
<b>PCIW-94ETD</b> 09030439	Comandi digitali • Digital controls / • Digitale Steuerungen • Commandes numériques / • <b>Controles digitales</b>			<b>5.703,00</b> 53 / 0,46
<b>PCI-98ET</b> 09030833	<b>PIANO COTTURA INDUZIONE TRIFASE -</b> N. 4 zone - Vetro cm.75x77 • Three-phase induction cooking - 4 zones - glass cm.75x77 • Induktions-Kochplatte dreiphasig - 4 zonen - Glas 75x77 cm • Plan de cuisson à induction triphasé N. 4 zones - Verre cm.75x77 • <b>Encimera inducción trifásica - 4 zonas - Vidrio cm.75x77 cm. 80x90x90h</b>		$\frac{20,0}{400V\sim 3}$ $\frac{50/60}{Hz}$	<b>13.857,00</b> 94 / 0,88
<b>PCI-98ETD</b> 09030838	Comandi digitali • Digital controls / • Digitale Steuerungen • Commandes numériques / • <b>Controles digitales</b>			<b>14.866,00</b> 94 / 0,88



# IPERLOTUS 90

MOD. \_\_\_\_\_  
COD. \_\_\_\_\_

DESCRIZIONE/DESCRIPTION/BEZEICHNUNG/DESCRIPTION/DESCRIPCIÓN  
DIMENSIONI/DIMENSIONS/ABMESSUNGEN/DIMENSIONS/DIMENSIONES

POTENZA/POWER/LEISTUNG/PUISSANCE/POTENCIA  
VOLTAGGIO/VOLTAGE/SPANNUNG/VOLTAGE/VOLTAJE

⊘ kW \_\_\_\_\_  
kcal/h \_\_\_\_\_

PREZZO/PRICE €  
PREIS/PRIX/PRECIO €  
KG / M<sup>3</sup>

**PC-94G**  
09210450

PIANO COTTURA GAS SU MOBILE  
A GIORNO 2 fuochi  
• Gas heated boiling unit on open cabinet - 2 burners  
• Gas-Kochplatte mit offenem Unterbau - 2 Kochstellen  
• Rechaud gaz sur armoire ouvert - 2 feuxvifs  
• **Sobres de cocción gas sobre mueble abierto - 2 quemadores**  
**cm. 40x90x90h**



⊘ 11 kW \_\_\_\_\_  
9.460 kcal/h \_\_\_\_\_

**1.675,00**  
71 / 0,46



**PC-98G**  
09210850

PIANO COTTURA GAS SU MOBILE  
A GIORNO 4 fuochi  
• Gas heated boiling unit on open cabinet - 4 burners  
• Gas-Kochplatte mit offenem Unterbau - 4 Kochstellen  
• Rechaud gaz sur armoire ouvert - 4 feuxvifs  
• **Sobres de cocción gas sobre mueble abierto - 4 quemadores**  
**cm. 80x90x90h**



⊘ 28 kW \_\_\_\_\_  
24.080 kcal/h \_\_\_\_\_

**2.670,00**  
100 / 0,88

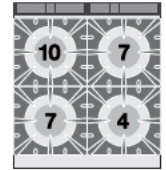

**PC-912G**  
09211250

PIANO COTTURA GAS SU MOBILE  
A GIORNO 6 fuochi  
• Gas heated boiling unit on open cabinet - 6 burners  
• Gas-Kochplatte mit offenem Unterbau - 6 Kochstellen  
• Rechaud gaz sur armoire ouvert - 6 feuxvifs  
• **Sobres de cocción gas sobre mueble abierto - 6 quemadores**  
**cm. 120x90x90h**



⊘ 45 kW \_\_\_\_\_  
38.700 kcal/h \_\_\_\_\_

**3.862,00**  
142 / 1,31

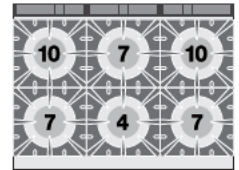

**PC-916G**  
09211650

PIANO COTTURA GAS SU MOBILE  
A GIORNO - 8 Fuochi  
• Gas heated boiling unit on open cabinet - 8 burners  
• Gas-Kochplatte mit offenem Unterbau - 8 Kochstellen  
• Rechaud gaz sur armoire ouvert - 8 feuxvifs  
• **Sobres de cocción gas sobre mueble abierto - 8 quemadores**  
**cm. 160x90x90h**



⊘ 56 kW \_\_\_\_\_  
48.160 kcal/h \_\_\_\_\_

**5.070,00**  
182 / 1,86

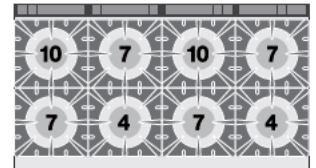

# IPERLOTUS 90

<b>MOD.</b> _____ <b>COD.</b> _____	<b>DESCRIZIONE / DESCRIPTION / BEZEICHNUNG / DESCRIPTION / DESCRIPCIÓN</b> <b>DIMENSIONI / DIMENSIONS / ABMESSUNGEN / DIMENSIONS / DIMENSIONES</b>	<b>POTENZA / POWER / LEISTUNG / PUISSANCE / POTENCIA</b> <b>VOLTAGGIO / VOLTAGE / SPANNUNG / VOLTAGE / VOLTAJE</b>	<b>kw</b> kcal/h	<b>PREZZO / PRICE / €</b> PREIS / PRX / PRECIO € KG / M <sup>3</sup>
--	---	---	---------------------	--

**PCA-94G**  
09310450

PIANO COTTURA ACQUA SU MOBILE A GIORNO  
2 fuochi - Rubinetto carico acqua, sfioratore  
• Water heated boiling unit on open cabinet - 2 burners -  
Water loading tap + overflow device  
• Wasser-Kochplatte mit offenem Unterbau - 2 Kochstellen -  
Wasserlauf-Hahn + Überlauf-Vorrichtung  
• Rechaud l'eau sur armoire ouvert - 2 feuxvifs -  
Robinet d'arrivée d'eau trop plein  
• **Sobres de cocción agua sobre mueble abierto**  
**2 quemadores - Grifo carga agua + vertedero**  
**cm. 40x90x90h**

14 kW  
12.040 kcal/h

**2.115,00**  
71 / 0,46

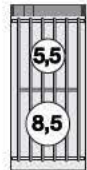

**PCA-98G**  
09310850

PIANO COTTURA ACQUA SU MOBILE A GIORNO -  
4 fuochi - Rubinetto carico acqua, sfioratore  
• Water heated boiling unit on open cabinet - 4 burners -  
Water loading tap + overflow device  
• Wasser-kochplatte mit offenem Unterbau - 4 Kochstellen -  
Wasserlauf-Hahn + Überlauf-Vorrichtung  
• Rechaud l'eau sur armoire ouvert - 4 feuxvifs -  
Robinet d'arrivée d'eau trop plein  
• **Sobres de cocción agua sobre mueble abierto**  
**4 quemadores - Grifo carga agua + vertedero**  
**cm. 80x90x90h**



28 kW  
24.080 kcal/h

**3.392,00**  
100 / 0,88



**PCA-912G**  
09311250

PIANO COTTURA ACQUA SU MOBILE A GIORNO  
6 fuochi - Rubinetto carico acqua, sfioratore  
• Water heated boiling unit on open cabinet - 6 burners -  
Water loading tap + overflow device  
• Wasser-kochplatte mit offenem Unterbau - 6 Kochstellen -  
Wasserlauf-Hahn + Überlauf-Vorrichtung  
• Rechaud l'eau sur armoire ouvert - 6 feuxvifs -  
Robinet d'arrivée d'eau trop plein  
• **Sobres de cocción agua sobre mueble abierto**  
**6 quemadores - Grifo carga agua + vertedero**  
**cm. 120x90x90h**

42 kW  
36.120 kcal/h

**4.897,00**  
142 / 1,31



**PA-98G**  
09210851

"PAELLERO" GAS SU MOBILE A GIORNO  
• "PAELLERO" Gas - open cabinet  
• "PAELLERO" Gas mit offenem Unterbau  
• "PAELLERO" gaz sur armoire ouvert  
• **"PAELLERO" gas sobre mueble abierto**  
**cm. 80x90x90h**



26,7 kW  
22.962 kcal/h

**3.798,00**  
134 / 0,88

**PAF-98G**  
09680851

"PAELLERO" GAS SU Forno a gas statico  
GN 2/1 cm. 68x73x34h  
• "PAELLERO" Gas - Traditional gas-oven  
GN 2/1 cm. 68x73x34h  
• "PAELLERO" Gas mit Statischer Gas-Backofen  
GN 2/1 cm. 68x73x34h  
• "PAELLERO" gaz sur Four à gaz statique  
GN 2/1 cm. 68x73x34h  
• **"PAELLERO" gas sobre Horno a gas estático**  
**GN 2/1 cm. 68x73x34h**  
**cm. 80x90x90h**



35,2 kW  
30.272 kcal/h

**5.013,00**  
184 / 0,88

# IPERLOTUS 90

MOD. COD.	DESCRIZIONE / DESCRIPTION / BEZEICHNUNG / DESCRIPTION / DESCRIPCIÓN DIMENSIONI / DIMENSIONS / ABMESSUNGEN / DIMENSIONS / DIMENSIONES	POTENZA / POWER / LEISTUNG / PUISSANCE / POTENCIA VOLTAGGIO / VOLTAGE / SPANNUNG / VOLTAGE / VOLTAJE	$\frac{kW}{kcal/h}$	$\frac{kW}{V-Hz}$	PREZZO / PRICE € PREIS / PRIX / PRECIO € KG / M <sup>3</sup>
--------------	---	---	---------------------	-------------------	--

<b>TP-94G</b> 09290450	TUTTA PIASTRA GAS SU MOBILE A GIORNO Piastra cm 37x73 <ul style="list-style-type: none"> <li>Solid top on open unit - plate 37x73cm</li> <li>Kochplatte auf offenem Unterbau - Platte 37x73 cm</li> <li>Toute plaque sur meuble ouvert - Plaque cm 37x73</li> <li><b>Placa de cocción sobre mueble abierto - Placa cm 37x73</b></li> <li><b>cm. 40x90x90h</b></li> </ul>		$\frac{7}{6.020}$		<b>2.011,00</b> 75 / 0,45
---------------------------	--	--	-------------------	--	------------------------------

<b>TP-98G</b> 09290850	TUTTA PIASTRA GAS SU MOBILE A GIORNO Piastra cm 77x73 <ul style="list-style-type: none"> <li>Solid top on open unit - Plate 77x73 cm</li> <li>Kochplatte auf offenem Unterbau - Platte 77x73 cm</li> <li>Toute plaque sur meuble ouvert - Plaque cm 77x73</li> <li><b>Placa de cocción sobre mueble abierto - Placa cm 77x73</b></li> <li><b>cm. 80x90x90h</b></li> </ul>		$\frac{12}{10.320}$		<b>2.951,00</b> 144 / 0,88
---------------------------	---	--	---------------------	--	-------------------------------

<b>TP2-98G</b> 09300850	TUTTA PIASTRA + 2 FUOCHI SU MOBILE A GIORNO Piastra cm. 37x73 <ul style="list-style-type: none"> <li>Solid top + 2 burners on open unit Plate 37x73</li> <li>Kochplatte + 2 Gaskochstellen auf offenem Unterbau Platte 37x73</li> <li>Toute plaque + 2 brûleurs sur meuble ouvert Plaque cm. 37x73</li> <li><b>Placa de cocción + 2 fuegos sobre mueble abierto Placa cm. 37x73</b></li> <li><b>cm. 80x90x90h</b></li> </ul>		$\frac{24}{20.640}$		<b>2.940,00</b> 139 / 0,88
----------------------------	--	--	---------------------	--	-------------------------------

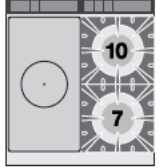

<b>TP2-912G</b> 09291250	TUTTA PIASTRA + 2 FUOCHI SU MOBILE A GIORNO Piastra cm. 77x73 <ul style="list-style-type: none"> <li>Solid top + 2 burners on open unit Plate 77x73</li> <li>Kochplatte + 2 Gaskochstellen auf offenem Unterbau Platte 77x73</li> <li>Toute plaque + 2 brûleurs sur meuble ouvert Plaque cm. 77x73</li> <li><b>Placa de cocción + 2 fuegos sobre mueble abierto Placa cm. 77x73</b></li> <li><b>cm. 120x90x90h</b></li> </ul>		$\frac{29}{24.940}$		<b>4.264,00</b> 166 / 1,31
-----------------------------	---	--	---------------------	--	-------------------------------







<b>TP4-912G</b> 09301250	TUTTA PIASTRA + 4 FUOCHI SU MOBILE A GIORNO Piastra cm. 37x73 <ul style="list-style-type: none"> <li>Solid top + 4 burners on open unit Plate 37x73 cm</li> <li>Kochplatte + 4 Gaskochstellen auf offenem Unterbau Platte 37x73 cm</li> <li>Toute plaque + 4 brûleurs sur meuble ouvert Plaque cm. 37x73</li> <li><b>Placa de cocción + 4 fuegos sobre mueble abierto Placa cm. 37x73</b></li> <li><b>cm. 120x90x90h</b></li> </ul>		$\frac{35}{30.100}$		<b>4.083,00</b> 160 / 1,31
-----------------------------	---	--	---------------------	--	-------------------------------

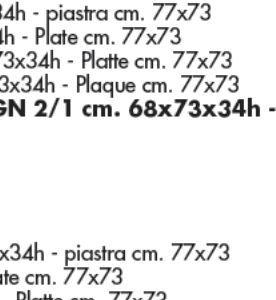
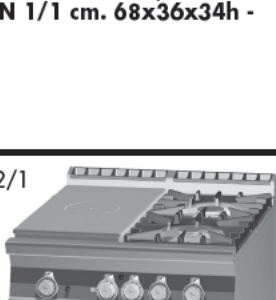

## IPERLOTUS 90

MOD. / COD.	DESCRIZIONE / DESCRIPTION / BEZEICHNUNG / DESCRIPTION / DESCRIPCIÓN DIMENSIONI / DIMENSIONS / ABMESSUNGEN / DIMENSIONS / DIMENSIONES	POTENZA / POWER / LEISTUNG / PUISSANCE / POTENCIA VOLTAGGIO / VOLTAGE / SPANNUNG / VOLTAGE / VOLTAJE	⚡ kW kcal/h	⚡ kw V- Hz	PREZZO / PRICE € PREIS / PRD / PRECIO € KG / M <sup>3</sup>
<b>TP-98ET</b> 09120830	TUTTA PIASTRA SU MOBILE A GIORNO Piastra cm. 70x68 - 4 zone • Solid top on open unit - Plate cm. 70x68 • Kochplatten auf offenem Unterbau - Platte cm. 70x68 • Toute plaque sur meuble ouvert - Plaque cm. 70x68 • <b>Placa de cocción sobre mueble abierto - Placa cm. 70x68 cm. 80x90x90h</b>		⚡ 13,6 kW 400V~3N 50/60 Hz		<b>3.568,00</b> 114 / 0,88
<b>TPI-98ET</b> 09120833	TUTTOPIANO INDUZIONE TRIFASE - Vetro cm.75x77 • Three-phase induction Solid top - glass cm.75x77 • Induktions-Kochplatte dreiphasig - Glas 75x77 cm • Toute plaque à induction triphasé - Verre cm.75x77 • <b>Placa de cocción inducción trifásica - Vidrio cm.75x77 cm. 80x90x90h</b>		⚡ 28 kW 400V~3 50/60 Hz		<b>20.765,00</b> 95 / 0,88
<b>TPI-98ETD</b> 09120838	Comandi digitali • Digital controls / • Digitale Steuerungen • Commandes numériques / • <b>Controles digitales</b>				<b>21.774,00</b> 95 / 0,88
<b>TPF-98ET</b> 09670830	Tutta piastra su Forno elettrico statico GN 2/1 cm. 68x73x34h - piastra cm. 70x68 4 zone • Solid top on traditional electric oven GN 2/1 cm. 68x73x34h - Plate cm. 70x68 4 zones • Kochplatten - Statischer Elektro-Backofen GN 2/1 cm. 68x73x34h - Platte cm. 70x68 4 zonen • Toute plaque sur Four électrique statique GN 2/1 cm. 68x73x34h - Plaque cm. 70x68 4 zones • <b>Placa de cocción sobre Horno eléctrico estático GN 2/1 cm. 68x73x34h - Placa cm. 70x68 4 zonas cm. 80x90x90h</b>		⚡ 20,3 kW 400V~3N 50/60 Hz		<b>4.570,00</b> 180 / 0,88
<b>TPFV-98ET</b> 09670835	Tutta piastra su Forno elettrico ventilato GN 1/1 cm. 68x36x34h - piastra cm. 70x68 4 zone • Solid top on electric fan oven GN 1/1 cm. 68x36x34h - Plate cm. 70x68 4 zones • Kochplatten - Elektro-Heißluftofen GN 1/1 cm. 68x36x34h - Platte cm. 70x68 4 Zonen • Toute plaque sur Four à chaleur tournante électrique GN 1/1 cm. 68x36x34h - Plaque cm. 70x68 4 zones • <b>Placa de cocción sobre Horno eléctrico ventilado GN 1/1 cm. 68x36x34h - Placa cm. 70x68 4 zonas cm. 80x90x90h</b>		⚡ 18,92 kW 400V~3N 50/60 Hz		<b>4.927,00</b> 180 / 0,88

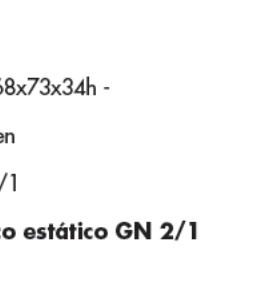
## IPERLOTUS 90

MOD. COD.	DESCRIZIONE/DESCRIPTION/BEZEICHNUNG/DESCRIPTION/DESCRIPCIÓN DIMENSIONI/DIMENSIONS/ABMESSUNGEN/DIMENSIONS/DIMENSIONES	POTENZA/POWER/LEISTUNG/PUISSANCE/POTENCIA VOLTAGGIO/VOLTAGE/SPANIUNG/VOLTAGE/VOLTAGE	€ kW kcal/h	PREZZO/PRICE € PREIS/PRIX/PRECIO € KG / M <sup>3</sup>
<b>TPF-98G</b> 09700850	TUTTA PIASTRA SU FORNO GAS statico GN 2/1 cm. 68x73x34h Piastra cm 77x73 <ul style="list-style-type: none"> <li>Solid top on Traditional gas-oven GN 2/1 cm. 68x73x34h - Plate cm. 77x73</li> <li>Kochplatten - Statischer Gas-Backofen GN 2/1 cm. 68x73x34h - Platte cm. 77x73</li> <li>Toute plaque sur Four à gaz statique GN 2/1 cm. 68x73x34h - Plaque cm. 77x73</li> </ul> <b>Placa de cocción sobre Horno a gas estático GN 2/1 cm. 68x73x34h - Placa cm. 77x73 cm. 80x90x90h</b>		20,5 kW 17.630 kcal/h	<b>4.268,00</b> 194 / 0,88
<b>TPF-98GE</b> 09710860	Tutta piastra su Forno elettrico statico GN 2/1 cm. 68x73x34h - piastra cm. 77x73 <ul style="list-style-type: none"> <li>Solid top on traditional electric oven GN 2/1 cm. 68x73x34h - Plate cm. 77x73</li> <li>Kochplatten - Statischer Elektro-Backofen GN 2/1 cm. 68x73x34h - Platte cm. 77x73</li> <li>Toute plaque sur Four électrique statique GN 2/1 cm. 68x73x34h - Plaque cm. 77x73</li> </ul> <b>Placa de cocción sobre Horno eléctrico estático GN 2/1 cm. 68x73x34h - Placa cm. 77x73 cm. 80x90x90h</b>		12 kW 10.320 kcal/h	<b>4.355,00</b> 196 / 0,88
<b>TPFV-98GE</b> 09710865	Tutta piastra su Forno elettrico ventilato GN 1/1 cm. 68x36x34h - piastra cm. 77x73 <ul style="list-style-type: none"> <li>Solid top on electric fan oven GN 1/1 cm. 68x36x34h - Plate cm. 77x73</li> <li>Kochplatten - Elektro-Heißluftofen GN 1/1 cm. 68x36x34h - Platte cm. 77x73</li> <li>Toute plaque sur Four à chaleur tournante électrique GN 1/1 cm. 68x36x34h - Plaque cm. 77x73</li> </ul> <b>Placa de cocción sobre Horno eléctrico ventilado GN 1/1 cm. 68x36x34h - Placa cm. 77x73 cm. 80x90x90h</b>		12 kW 10.320 kcal/h	<b>4.712,00</b> 196 / 0,88
<b>TPF2-98G</b> 09720850	TUTTA PIASTRA + 2 FUOCHI SU FORNO GAS statico GN 2/1 cm. 68x73x34h - Piastra cm 37x73 <ul style="list-style-type: none"> <li>Solid top + 2 burners Traditional gas-oven GN 2/1 cm. 68x73x34h - Plate 37x73</li> <li>Kochplatte + 2 Gaskochstellen auf Statischer Gas-Backofen GN 2/1 cm. 68x73x34h Platte 37x73 cm</li> <li>Toute plaque + 2 brûleurs sur Four à gaz statique GN 2/1 cm. 68x73x34h Plaque cm. 37x73</li> </ul> <b>Placa de cocción + 2 fuegos sobre Horno a gas estático GN 2/1 cm. 68x73x34h Placa cm 37x73 cm. 80x90x90h</b>		32,5 kW 27.950 kcal/h	<b>4.297,00</b> 181 / 0,88
<b>TPF2-98GE</b> 09730860	TUTTA PIASTRA + 2 FUOCHI SU Forno elettrico statico GN 2/1 cm. 68x73x34h - Piastra cm 37x73 <ul style="list-style-type: none"> <li>Solid top + 2 burners traditional electric oven GN 2/1 cm. 68x73x34h - Plate 37x73</li> <li>Kochplatte + 2 Gaskochstellen auf Statischer Elektro-Backofen GN 2/1 cm. 68x73x34h Platte 37x73</li> <li>Toute plaque + 2 brûleurs sur Four électrique statique GN 2/1 cm. 68x73x34h Plaque cm. 37x73</li> </ul> <b>Placa de cocción + 2 fuegos sobre Horno eléctrico estático GN 2/1 cm. 68x73x34h Placa cm 37x73 cm. 80x90x90h</b>		24 kW 20.640 kcal/h	<b>4.384,00</b> 191 / 0,88
<b>TPFV2-98GE</b> 09730865	TUTTA PIASTRA + 2 FUOCHI SU Forno elettrico ventilato GN 1/1 cm. 68x36x34h - Piastra cm 37x73 <ul style="list-style-type: none"> <li>Solid top + 2 burners electric fan oven GN 1/1 cm. 68x36x34h - Plate 37x73</li> <li>Kochplatte + 2 Gaskochstellen - Elektro-Heißluftofen GN 1/1 cm. 68x36x34h Platte 37x73</li> <li>Toute plaque + 2 brûleurs sur Four à chaleur tournante électrique GN 1/1 cm. 68x36x34h Plaque cm. 37x73</li> </ul> <b>Placa de cocción + 2 fuegos sobre Horno eléctrico ventilado GN 1/1 cm. 68x36x34h Placa cm 37x73 cm. 80x90x90h</b>		24 kW 20.640 kcal/h	<b>4.740,00</b> 191 / 0,88

# IPERLOTUS 90

MOD. \_\_\_\_\_ DESCRIZIONE/DESCRIPTION/BEZEICHNUNG/DESCRIPTION/DESCRIPCIÓN POTENZA/POWER/LEISTUNG/PUISSANCE/POTENCIA PREZZO/PRICE €  
 COD. \_\_\_\_\_ DIMENSIONI/DIMENSIONS/ABMESSUNGEN/DIMENSIONS/DIMENSIONES VOLTAGGIO/VOLTAGE/SPANNUNG/VOLTAGE/VOLTAJE kcal/h kw V- Hz PREIS/PRIX/PRECIO € KG / M<sup>3</sup>

**TPF2-912GV** TUTTA PIASTRA + 2 FUOCHI SU FORNO GAS  
 09701251 statico GN 2/1 cm. 68x73x34h - Piastra cm 77x73 - vano neutro con porta  
 • Solid top + 2 burners Traditional gas-oven GN 2/1 cm. 68x73x34h - Plate 77x73cm - Neutral cabinet with door  
 • Kochplatte + 2 Gaskochstellen auf Statischer Gas-Backofen GN 2/1 cm. 68x73x34h Platte 77x73 cm - Neutrales Schrankelement mit Tür  
 • Toute plaque + 2 brûleurs sur Four à gaz statique GN 2/1 cm. 68x73x34h Plaque cm. 77x73 - Element neutre avec porte  
 • **Placa de cocción + 2 fuegos sobre Horno a gas estático GN 2/1 cm. 68x73x34h Placa cm 77x73 - Armario neutro con puerta cm. 120x90x90h**



37,5 kW 5.745,00  
 32.250 kcal/h 254 / 1,31

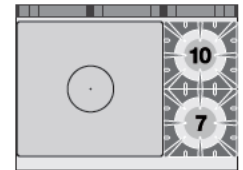

**TPF2-912GEV** TUTTA PIASTRA + 2 FUOCHI SU Forno elettrico statico GN 2/1  
 09711261 cm. 68x73x34h - Piastra cm 77x73 - vano neutro con porta  
 • Solid top + 2 burners traditional electric oven GN 2/1 cm. 68x73x34h - Plate 77x73cm - Neutral cabinet with door  
 • Kochplatte + 2 Gaskochstellen auf Statischer Elektro-Backofen GN 2/1 cm. 68x73x34h Platte 77x73 cm - Neutrales Schrankelement mit Tür  
 • Toute plaque + 2 brûleurs sur Four électrique statique GN 2/1 cm. 68x73x34h Plaque cm. 77x73 - Element neutre avec porte  
 • **Placa de cocción + 2 fuegos sobre Horno eléctrico estático GN 2/1 cm. 68x73x34h Placa cm 77x73 - Armario neutro con puerta cm. 120x90x90h**

29 kW 5.832,00  
 24.940 kcal/h 250 / 1,31

6,7 kW  
 400V~3N  
 50/60 Hz

**TPFV2-912GEV** TUTTA PIASTRA + 2 FUOCHI SU Forno elettrico ventilato GN 1/1  
 09711266 cm. 68x36x34h - Piastra cm 77x73 - vano neutro con porta  
 • Solid top + 2 burners electric fan oven GN 1/1 cm. 68x36x34h - Plate 77x73cm - Neutral cabinet with door  
 • Kochplatte + 2 Gaskochstellen - Elektro-Heißluftofen GN 1/1 cm. 68x36x34h - Platte 77x73 cm - Neutrales Schrankelement mit Tür  
 • Toute plaque + 2 brûleurs sur Four à chaleur tournante électrique GN 1/1 cm. 68x36x34h - Plaque cm. 77x73 - Element neutre avec porte  
 • **Placa de cocción + 2 fuegos sobre Horno eléctrico ventilado GN 1/1 cm. 68x36x34h - Placa cm 77x73 - Armario neutro con puerta cm. 120x90x90h**

29 kW 6.189,00  
 24.940 kcal/h 250 / 1,31

5,32 kW  
 400V~3N  
 230V~3  
 50/60 Hz

**TPF2-912G** TUTTA PIASTRA + 2 FUOCHI SU FORNO GAS  
 09701250 statico GN 3/1 cm. 108x73x34h - Piastra cm 77x73  
 • Solid top + 2 burners Traditional gas-oven GN 3/1 cm. 108x73x34h - Plate 77x73  
 • Kochplatte + 2 Gaskochstellen auf Statischer Gas-Backofen GN 3/1 cm. 108x73x34h Platte 77x73  
 • Toute plaque + 2 brûleurs sur Four à gaz statique GN 3/1 cm. 108x73x34h Plaque cm. 77x73  
 • **Placa de cocción + 2 fuegos sobre Horno a gas estático GN 3/1 cm. 108x73x34h Placa cm 77x73 cm. 120x90x90h**



42 kW 6.024,00  
 36.080 kcal/h 264 / 1,31

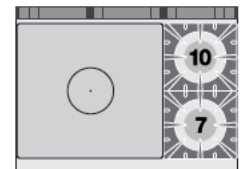

**TPF2-912GE** TUTTA PIASTRA + 2 FUOCHI SU Forno elettrico  
 09711260 statico GN 3/1 cm. 108x73x34h - Piastra cm 77x73  
 • Solid top + 2 burners traditional electric oven GN 3/1 cm. 108x73x34h - Plate 77x73  
 • Kochplatte + 2 Gaskochstellen auf Statischer Elektro-Backofen GN 3/1 cm. 108x73x34h Platte 77x73  
 • Toute plaque + 2 brûleurs sur Four électrique statique GN 3/1 cm. 108x73x34h Plaque cm. 77x73  
 • **Placa de cocción + 2 fuegos sobre Horno eléctrico estático GN 3/1 cm. 108x73x34h Placa cm 77x73 cm. 120x90x90h**

29 kW 6.138,00  
 24.940 kcal/h 260 / 1,31

9,2 kW  
 400V~3N  
 50/60 Hz

## IPERLOTUS 90

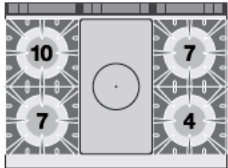
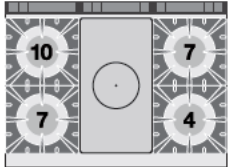
MOD. COD.	DESCRIZIONE / DESCRIPTION / BEZEICHNUNG / DESCRIPCIÓN / DIMENSIONI / DIMENSIONS / ABMESSUNGEN / DIMENSIONES	POTENZA / POWER / LEISTUNG / PUISSANCE / POTENCIA VOLTAGGIO / VOLTAGE / SPANNUNG / VOLTAGE / VOLTAGE	kW kcal/h	PREZZO / PRICE € PREIS / PRIX / PRECIO KG / M <sup>3</sup>
TPF4-912GV 09721251	TUTTA PIASTRA + 4 FUOCHI SU FORNO GAS statico GN 2/1 cm. 68x73x34h - Piastra cm 37x73 - vano neutro con porta • Solid top + 4 burners Traditional gas-oven GN 2/1 cm. 68x73x34h - Plate 37x73cm - Neutral cabinet with door • Kochplatte + 4 Gaskochstellen auf Statischer Gas-Backofen GN 2/1 cm. 68x73x34h Platte 37x73 cm - Neutrales Schrankelement mit Tür • Toute plaque + 4 brûleurs sur Four à gaz statique GN 2/1 cm. 68x73x34h Plaque cm. 37x73 - Element neutre avec porte • <b>Placa de cocción + 4 fuegos sobre Horno a gas estático GN 2/1 cm. 68x73x34h Placa cm 37x73 - Armario neutro con puerta cm. 120x90x90h</b>		43,5 kW 37.410 kcal/h	5.824,00 249 / 1,31
				
TPF4-912GEV 09731261	TUTTA PIASTRA + 4 FUOCHI SU Forno elettrico statico GN 2/1 cm. 68x73x34h - Piastra cm 37x73 - vano neutro con porta • Solid top + 4 burners traditional elettric oven GN 2/1 cm. 68x73x34h - Plate 37x73cm - Neutral cabinet with door • Kochplatte + 4 Gaskochstellen auf Statischer Elektro-Backofen GN 2/1 cm. 68x73x34h Platte 37x73 cm - Neutrales Schrankelement mit Tür • Toute plaque + 4 brûleurs sur Four électrique statique GN 2/1 cm. 68x73x34h Plaque cm. 37x73 - Element neutre avec porte • <b>Placa de cocción + 4 fuegos sobre Horno eléctrico estático GN 2/1 cm. 68x73x34h Placa cm 37x73 - Armario neutro con puerta cm. 120x90x90h</b>		35 kW 30.100 kcal/h	5.910,00 245 / 1,31
			6,7 kW 400V~3N 50/60 Hz	
TPFV4-912GEV 09731266	TUTTA PIASTRA + 4 FUOCHI SU Forno elettrico ventilato GN 1/1 cm. 68x36x34h - Piastra cm 37x73 - vano neutro con porta • Solid top + 4 burners electric fan oven GN 1/1 cm. 68x36x34h - Plate 37x73cm - Neutral cabinet with door • Kochplatte + 4 Gaskochstellen - Elektro-Heißluftofen GN 1/1 cm. 68x36x34h Platte 37x73 cm - Neutrales Schrankelement mit Tür • Toute plaque + 4 brûleurs sur Four à chaleur tournante électrique GN 1/1 cm. 68x36x34h Plaque cm. 37x73 - Element neutre avec porte • <b>Placa de cocción + 4 fuegos sobre Horno eléctrico ventilado GN 1/1 cm. 68x36x34h - Placa cm 37x73 - Armario neutro con puerta cm. 120x90x90h</b>		35 kW 30.100 kcal/h	6.267,00 245 / 1,31
			5,32 kW 400V~3N 230V~3 50/60 Hz	
TPF4-912G 09721250	TUTTA PIASTRA + 4 FUOCHI SU FORNO GAS statico GN 3/1 cm. 108x73x34h - Piastra cm 37x73 • Solid top + 4 burners Traditional gas-oven GN 3/1 cm. 108x73x34h - Plate 37x73cm • Kochplatte + 4 Gaskochstellen auf Statischer Gas-Backofen GN 3/1 cm. 108x73x34h Platte 37x73 cm • Toute plaque + 4 brûleurs sur Four à gaz statique GN 3/1 cm. 108x73x34h Plaque cm. 37x73 • <b>Placa de cocción + 4 fuegos sobre Horno a gas estático GN 3/1 cm. 108x73x34h Placa cm 37x73 cm. 120x90x90h</b>		48 kW 41.280 kcal/h	6.189,00 259 / 1,31
				
TPF4-912GE 09731260	TUTTA PIASTRA + 4 FUOCHI SU Forno elettrico statico GN 3/1 cm. 108x73x34h - Piastra cm 37x73 • Solid top + 4 burners traditional elettric oven GN 3/1 cm. 108x73x34h - Plate 37x73cm • Kochplatte + 4 Gaskochstellen auf Statischer Elektro-Backofen GN 3/1 cm. 108x73x34h Platte 37x73 cm • Toute plaque + 4 brûleurs sur Four électrique statique GN 3/1 cm. 108x73x34h Plaque cm. 37x73 • <b>Placa de cocción + 4 fuegos sobre Horno eléctrico estático GN 3/1 cm. 108x73x34h Placa cm 37x73 cm. 120x90x90h</b>		35 kW 30.100 kcal/h	6.300,00 255 / 1,31
			9,2 kW 400V~3N 50/60 Hz	

# IPERLOTUS 90

<b>MOD.</b> _____ <b>COD.</b> _____	<b>DESCRIZIONE/DESCRIPTION/BEZEICHNUNG/DESCRIPTION/DESCRIPCIÓN</b> <b>DIMENSIONI/DIMENSIONS/ABMESSUNGEN/DIMENSIONS/DIMENSIONES</b>	<b>POTENZA/POWER/LEISTUNG/PUISSANCE/POTENCIA</b> <b>VOLTAGGIO/VOLTAGE/SPANNUNG/VOLTAGE/VOLTAJE</b>	<b>kW</b> kcal/h	<b>kw</b> V~ Hz	<b>PREZZO/PRICE</b> € <b>PREIS/PRIX/PRECIO</b> € KG / M <sup>3</sup>
--	---	---	---------------------	-----------------------	--

**BM-94EM**  
09050410

**BAGNOMARIA MONOFASE SU MOBILE**  
A GIORNO Vasca per GN 1/1 + GN 1/3 h. 15  
Rubinetto carico acqua, scarico a pavimento

- Bain-marie singlephase on open cabinet - Bowl for GN 1/1 + GN 1/3 h.15 - Water loading tap floor draining
- Wasserbäder einphasig mit Offenem Unterbau - Becken GN 1/1 + GN 1/3 h.15 - Wasserlauf-Hahn, Ablauf am Boden
- Bain marie monophasé sur armoire ouvert Cuve GN 1/1 + GN 1/3 h.15 Robinet d'arrivée d'eau - Système de vidange au sol
- **Baño de maría monofásico sobre mueble abierto Cuba para GN 1/1 + GN 1/3 15h Grifo carga agua, descarga a pavimento**  
**cm. 40x90x90h**



2,85 kW  
230V~  
50/60 Hz

**1.850,00**  
52 / 0,46

**BM-94G**  
09220450

**BAGNOMARIA GAS SU MOBILE A GIORNO**  
Vasca per GN 1/1 + GN 1/3 h.15 Rubinetto carico acqua, scarico a pavimento

- Gas bain-marie on open cabinet - Bowl for GN 1/1 + GN 1/3 h.15 - Water loading tap and floor draining
- Gas Wasserbad mit offenem Unterbau - Becken GN 1/1 + GN 1/3 h.15 - Wasserlauf-Hahn, Ablauf am Boden
- Bain-marie gaz sur armoire ouvert Cuve pour GN 1/1 + GN 1/3 h.15 Robinet d'arrivée d'eau, système de vidange au sol
- **Baño de maría gas sobre mueble abierto Cuba para GN 1/1 + GN 1/3 h.15 Grifo carga agua, descarga a pavimento**  
**cm. 40x90x90h**



3,5 kW  
3.010 kcal/h

**1.985,00**  
56 / 0,46

**BS-94EM**  
09040410

**CONTENITORE CALDO CON INFRAROSSO,**  
MONOFASE SU MOBILE A GIORNO  
Vasca cm. 30,5x51x16,5h con falsofondo forato

- Fry dump singlephase with infra-red heater on open cabinet. Bowl cm. 30,5x51x16,5h with perforated double bottom
- Frittenwanne Einphasig mit Infrarot-strahler mit offenem Unterbau. Becke cm. 30,5x51x16,5h mit gelochtem Bodenrost
- Silo a frites monophasé avec infrarouge sur armoire ouvert. Cuve cm 30,5x51x16,5h avec double-fond perforé.
- **Contenedor caliente por infrarrojo, monofásico y sobre mueble abierto. Cuba cm. 30,5x51x16,5h con falso fondo agujereado**  
**cm. 40x90x90h**



1,47 kW  
230V~  
50/60 Hz

**2.013,00**  
60 / 0,46

**BM-98ET**  
09050830

**BAGNOMARIA TRIFASE SU MOBILE A GIORNO -**  
Vasca per GN 2/1 + 2 xGN 1/3 15h  
Rubinetto carico acqua + scarico a pavimento

- Bain-marie threephase on open cabinet - Bowl for GN 2/1 + 2 xGN 1/3 15h - Floor draining
- Wasserbäder dreiphasisig mit offenem Unterbau - Becken GN 2/1 + 2 xGN 1/3 15h - Ablauf am Boden
- Bain marie triphase sur armoire ouvert - Cuve GN 2/1 + 2 xGN 1/3 15h - Système de vidange au sol
- **Baño de maría trifásico sobre mueble abierto Cuba para GN 2/1 + 2 xGN 1/3 h.15 - Descarga a pavimento**  
**cm. 80x90x90h**



5,7 kW  
400V~3N  
230V~3  
50/60 Hz

**2.498,00**  
76 / 0,88

**BM-98G**  
09220850

**BAGNOMARIA GAS SU MOBILE A GIORNO**  
Vasca per GN 2/1 + 2 xGN 1/3 h.15  
Rubinetto carico acqua, scarico a pavimento

- Gas bain-marie on open cabinet - Bowl for GN 2/1 + 2 xGN 1/3 h.15 - Water loading tap and floor draining
- Gas Wasserbad mit offenem Unterbau - Becken GN 2/1 + 2 xGN 1/3 h.15 - Wasserlauf-Hahn, Ablauf am Boden
- Bain-marie gaz sur armoire ouvert Cuve pour GN 2/1 + 2 xGN 1/3 h.15 Robinet d'arrivée d'eau, système de vidange au sol
- **Baño de maría gas sobre mueble abierto Cuba para GN 2/1 + 2 xGN 1/3 h.15 Grifo carga agua, descarga a pavimento**  
**cm. 80x90x90h**



6,5 kW  
5.590 kcal/h

**2.872,00**  
81 / 0,88



# IPERLOTUS 90

MOD. \_\_\_\_\_ DESCRIZIONE/DESCRIPTION/BEZEICHNUNG/DESCRIPTION/DESCRIPCIÓN POTENZA/POWER/LEISTUNG/PUISSANCE/POTENCIA PREZZO/PRICE €  
 COD. \_\_\_\_\_ DIMENSIONI/DIMENSIONS/ABMESSUNGEN/DIMENSIONS/DIMENSIONES VOLTAGGIO/VOLTAGE/SPANIUNG/VOLTAGE/VOLTAGE kcal/h kw V~ PREIS/PRIX/PRECIO €  
 KG / M<sup>3</sup>

**CP-94ET**  
09100430 CUOCIPASTA TRIFASE LT. 40 Vasca cm. 30,7x50,9x32,7h per GN 1/1 - Rubinetto carico acqua, sfioratore + scarico a pavimento  
 • Pasta cooker threephase 40 lts. Tank cm. 30,7x50,9x32,7h for GN 1/1 - Water loading tap + overflow device and floor draining  
 • Nudelkocher dreiphasig lt. 40 - Becken cm. 30,7x50,9x32,7h für GN 1/1, Wasserlauf-Hahn + Überlauf-Vorrichtung und Ablauf am Boden  
 • Cuiseur a pates triphase lt. 40 Cuve cm.30,7x50,9x32,7h pour GN 1/1, Robinet d'arrivée d'eau trop plein + système de vidange au sol  
 • **Cucee pasta trifásico lt. 40 - Cuba cm. 30,7x50,9x32,7h para GN 1/1, Grifo carga agua + vertedero + descarga a pavimento cm. 40x90x90h**



13,5 kW 3.001,00  
 400V~3N 57 / 0,46  
 50/60 Hz

**CPA-94ET**  
09100435 Carico acqua automatico con sensore di livello  
 • Automatic Water loading with level sensor  
 • Automatische Wasser Beladung mit Niveauregulierung  
 • Chargement automatique de l'eau avec sensor de niveau  
 • **Carga automática de agua con sensor de nivel**



13,5 kW 3.390,00  
 400V~3N 57 / 0,46  
 50/60 Hz

1/1	1/2	1/3	1/3	1/6	1/6
	1/2	1/3	2/3	1/3	1/6
		1/3		1/3	1/6

### COMBINAZIONI

- Combinations / • Zusammenstellungen
- Combinaisons / • **Combinación múltiple**

**CP-94G**  
09270450 CUOCIPASTA GAS LT. 40 Vasca cm. 30,7x50,9x32,7h per GN 1/1 - Rubinetto carico acqua, sfioratore + scarico a pavimento  
 • Gas pasta cooker 40 lts. - Tank cm. 30,7x50,9x32,7h for GN 1/1 - Water loading tap + overflow device and floor draining  
 • Gas-Nudelkocher lt. 40 - Becken cm. 30,7x50,9x32,7h für GN 1/1, Wasserlauf-Hahn + Überlauf-Vorrichtung und Ablauf am Boden  
 • Cuiseur a pates gaz lt. 40 - Cuve cm.30,7x50,9x32,7h pour GN 1/1, Robinet d'arrivée d'eau trop plein Système de vidange au sol  
 • **Cucee pasta gas 40 lt. - Cuba cm. 30,7x50,9x32,7h para GN 1/1, Grifo carga agua + vertedero + descarga a pavimento. cm. 40x90x90h**



13,95 kW 3.114,00  
 11.997 kcal/h 68 / 0,46

0,02 KW  
 230V~  
 50/60 Hz

**CPA-94G**  
09270455 Carico acqua automatico con sensore di livello  
 • Automatic Water loading with level sensor  
 • Automatische Wasser Beladung mit Niveauregulierung  
 • Chargement automatique de l'eau avec sensor de niveau  
 • **Carga automática de agua con sensor de nivel**



13,95 kW 3.338,00  
 11.997 kcal/h 68 / 0,46

0,035 KW  
 230V~  
 50/60 Hz

1/1	1/2	1/3	1/3	1/6	1/6
	1/2	1/3	2/3	1/3	1/6
		1/3		1/3	1/6

### COMBINAZIONI

- Combinations / • Zusammenstellungen
- Combinaisons / • **Combinación múltiple**

# IPERLOTUS 90

MOD. \_\_\_\_\_  
COD. \_\_\_\_\_

DESCRIZIONE / DESCRIPTION / BEZEICHNUNG / DESCRIPTION / DESCRIPCIÓN  
DIMENSIONI / DIMENSIONS / ABMESSUNGEN / DIMENSIONS / DIMENSIONES

POTENZA / POWER / LEISTUNG / PUISSANCE / POTENCIA  
VOLTAGGIO / VOLTAGE / SPANNUNG / VOLTAGE / VOLTAJE

⚡ kW \_\_\_\_\_  
kcal/h \_\_\_\_\_  
V- \_\_\_\_\_  
Hz \_\_\_\_\_

PREZZO / PRICE / €  
PREIS / FRID / PRECIO / €  
KG / M<sup>3</sup>

**CP-98ET**  
09100830

CUOCIPASTA TRIFASE LT. 40+40 2 Vasche cm. 30,7x50,9x32,7h per GN 1/1 - Rubinetto carico acqua, sfioratore + scarico a pavimento

- Pasta cooker threephase 40+40 lts. 2 Tanks cm. 30,7x50,9x32,7h for GN 1/1 - Water loading tap + overflow device and floor draining
- Nudelkocher dreiphasig lt. 40+40 2 Becken cm. 30,7x50,9x32,7h für GN 1/1, Wasserlauf-Hahn + Überlauf-Vorrichtung und Ablauf am Boden
- Cuiseur a pates triphase lt. 40+40 2 Cuves cm. 30,7x50,9x32,7h pour GN 1/1, - Robinet d'arrivée d'eau trop plein + système de vidange au sol
- **Cuece pasta trifásico 40+40 lt. 2 Cubas cm. 30,7x50,9x32,7h para GN 1/1, Grifo carga agua + vertedero + descarga a pavimento cm. 80x90x90h**



⚡ 27 kW \_\_\_\_\_ **5.014,00**  
400V~3N \_\_\_\_\_ 98 / 0,88  
50/60 Hz

**CPA-98ET**  
09100835

Carico acqua automatico con sensore di livello

- Automatic Water loading with level sensor
- Automatische Wasser Beladung mit Niveauregulierung
- Chargement automatique de l'eau avec sensor de niveau
- **Carga automática de agua con sensor de nivel**



⚡ 27 kW \_\_\_\_\_ **5.794,00**  
400V~3N \_\_\_\_\_ 98 / 0,88  
50/60 Hz

1/1	1/2	1/3	1/3	1/6/1/6	1/6/1/6
	1/2	1/3	2/3	1/3	1/6/1/6
		1/3		1/3	1/6/1/6

COMBINAZIONI

- Combinations / • Zusammenstellungen
- Combinaisons / • **Combinación múltiple**

**CP-98G**  
09270850

CUOCIPASTA GAS LT. 40+40 2 Vasche cm. 30,7x50,9x32,7h per GN 1/1 - Rubinetto carico acqua, sfioratore + scarico a pavimento

- Gas pasta cooker 40+40 lts 2 Tanks cm. 30,7x50,9x32,7h for GN 1/1 - Water loading, tap + overflow device and floor draining
- Gas-Nudelkocher lt. 40+40 2 Becken cm. 30,7x50,9x32,7h für GN 1/1, Wasserlauf-Hahn, Überlauf-Vorrichtung und Ablauf am Boden
- Cuiseur a pates gaz lt. 40+40 2 Cuve cm. 30,7x50,9x32,7h pour GN 1/1, - Robinet d'arrivée d'eau trop plein + système de vidange au sol
- **Cuece pasta gas 40+40 lt. 2 Cubas cm. 30,7x50,9x32,7h para GN 1/1, Grifo carga agua + vertedero + descarga a pavimento cm. 80x90x90h**



⚡ 27,9 kW \_\_\_\_\_ **5.267,00**  
23.994 kcal/h \_\_\_\_\_ 116 / 0,88

⚡ 0,04 KW \_\_\_\_\_  
230V~ \_\_\_\_\_  
50/60 Hz

**CPA-98G**  
09270855

Carico acqua automatico con sensore di livello

- Automatic Water loading with level sensor
- Automatische Wasser Beladung mit Niveauregulierung
- Chargement automatique de l'eau avec sensor de niveau
- **Carga automática de agua con sensor de nivel**



⚡ 27,9 kW \_\_\_\_\_ **5.712,00**  
23.994 kcal/h \_\_\_\_\_ 116 / 0,88

⚡ 0,07 KW \_\_\_\_\_  
230V~ \_\_\_\_\_  
50/60 Hz

1/1	1/2	1/3	1/3	1/6/1/6	1/6/1/6
	1/2	1/3	2/3	1/3	1/6/1/6
		1/3		1/3	1/6/1/6

COMBINAZIONI

- Combinations / • Zusammenstellungen
- Combinaisons / • **Combinación múltiple**

# IPERLOTUS 90

MOD. \_\_\_\_\_  
COD. \_\_\_\_\_

DESCRIZIONE/DESCRIPTION/BEZEICHNUNG/DESCRIPTION/DESCRIPCIÓN  
DIMENSIONI/DIMENSIONS/ABMESSUNGEN/DIMENSIONS/DIMENSIONES

POTENZA/POWER/LEISTUNG/PUISSANCE/POTENCIA  
VOLTAGGIO/VOLTAGE/SPANNUNG/VOLTAGE/VOLTAJE

⊕ kW  
kcal/h

⊖ kW  
V~  
Hz

PREZZO/PRICE €  
PREIS/PRIX/PRECIO €  
KG / M<sup>3</sup>

**CPB-98ET**  
09100831

**CUOCIPASTA TRIFASE LT. 80**  
Vasca cm. 62x50,9x32,7h per GN 2/1 - Rubinetto carico acqua, sfioratore + scarico a pavimento  
• Pasta cooker threephase 80 lts. - Tank cm. 62x50,9x32,7h for GN 2/1 - Water loading tap + overflow device and floor draining  
• Nudelkocher dreiphasig lt. 80 - Becken cm. 62x50,9x32,7h für GN 2/1, Wasserlauf-Hahn + Überlauf-Vorrichtung und Ablauf am Boden  
• Cuiseur a pates triphase lt. 80 - Cuve cm. 62x50,9x32,7h pour GN 2/1, Robinet d'arrivée d'eau trop plein + système de vidange au sol  
• **Cuece pasta trifásico lt. 80 - Cuba cm. 62x50,9x32,7h para GN 2/1, Grifo carga agua + vertedero + descarga a pavimento cm. 80x90x90h**



⊕ 27 kW  
400V~3N  
50/60 Hz

**4.570,00**  
93 / 0,88

1/1	1/2	1/3	1/3	1/6	1/6	1/6
	1/2	1/3	2/3	1/3	1/6	1/6
		1/3		1/3	1/6	1/6

COMBINAZIONI X 2

- Combinations x 2 / • Zusammenstellungen x 2
- Combinaisons x 2 / • **Combinación múltiple x 2**

**CPB-98G**  
09270851

**CUOCIPASTA GAS LT. 80** Vasca cm. 62x50,9x32,7h per GN 2/1 - Rubinetto carico acqua, sfioratore + scarico a pavimento  
• Gas pasta cooker 80 lts. - Tank cm. 62x50,9x32,7h for GN 2/1 - Water loading tap + overflow device and floor draining  
• Gas-Nudelkocher lt. 80 - Becken cm. 62x50,9x32,7h für GN 2/1, Wasserlauf-Hahn + Überlauf-Vorrichtung und Ablauf am Boden  
• Cuiseur a pates gaz lt. 80 - Cuve cm. 62x50,9x32,7h pour GN 2/1, Robinet d'arrivée d'eau trop plein + système de vidange au sol  
• **Cuece pasta gas 80 lt. - Cuba cm. 62x50,9x32,7h para GN 2/1, Grifo carga agua + vertedero + descarga a pavimento cm. 80x90x90h**



⊕ 31,5 kW  
27.060 kcal/h

⊖ 0,02 KW  
230V~  
50/60 Hz

**4.647,00**  
110 / 0,88

1/1	1/2	1/3	1/3	1/6	1/6	1/6
	1/2	1/3	2/3	1/3	1/6	1/6
		1/3		1/3	1/6	1/6

COMBINAZIONI X 2

- Combinations x 2 / • Zusammenstellungen x 2
- Combinaisons x 2 / • **Combinación múltiple x 2**

**CPP-94G**  
09270452

**CUOCIPASTA GAS POTENZIATO LT. 40**  
Vasca cm. 30,7x50,9x32,7h per GN 1/1 - Rubinetto carico acqua, sfioratore + scarico a pavimento  
• Powerfull Gas pasta cooker 40 lts. - Tank cm. 30,7x50,9x32,7h for GN 1/1 - Water loading tap + overflow device and floor draining  
• Gas-Nudelkocher leistungsfähiges lt. 40 - Becken cm. 30,7x50,9x32,7h für GN 1/1, Wasserlauf-Hahn + Überlauf-Vorrichtung und Ablauf am Boden  
• Cuiseur a pates gaz plus puissants lt. 40 - Cuve cm.30,7x50,9x32,7h pour GN 1/1, Robinet d'arrivée d'eau trop plein Système de vidange au sol  
• **Cuece pasta gas con mayor potencia 40 lt. - Cuba cm. 30,7x50,9x32,7h para GN 1/1, Grifo carga agua + vertedero + descarga a pavimento. cm. 40x90x90h**



⊕ 23,5 kW  
20.210 kcal/h

⊖ 0,02 KW  
230V~  
50/60 Hz

**3.536,00**  
69 / 0,54

**CPPA-94G**  
09270457

Carico acqua automatico con sensore di livello  
• Automatic Water loading with level sensor  
• Automatische Wasser Beladung mit Niveauregulierung  
• Chargement automatique de l'eau avec sensor de niveau  
• **Carga automática de agua con sensor de nivel**



⊕ 23,5 kW  
20.210 kcal/h

⊖ 0,035 KW  
230V~  
50/60 Hz

**3.753,00**  
69 / 0,54

# IPERLOTUS 90

MOD. \_\_\_\_\_ DESCRIZIONE/DESCRIPTION/BEZEICHNUNG/DESCRIPTION/DESCRIPCIÓN POTENZA/POWER/LEISTUNG/PUISSANCE/POTENCIA 6kW 1/3kw PREZZO/PRICE €  
 COD. \_\_\_\_\_ DIMENSIONI/DIMENSIONS/ABMESSUNGEN/DIMENSIONS/DIMENSIONES VOLTAGGIO/VOLTAGE/SPANNUNG/VOLTAGE/VOLTAJE kcal/h V- Hz PREIS/PRIX/PRECIO €  
 KG / M<sup>3</sup>

**SCCP-92EM** SOLLEVATORE CESTI DA AFFIANCARE  
 09140210 AI CUOCIPASTA CP-94/98, sollevamento automatico temporizzato o manuale, 3 aste  
 • Basket elevator for pasta cooker CP-94/98, automatic timed or manual lifting, 3 rods  
 • Heben Korbe für Nudelkocher CP-94/98, Timed oder manuelle Heben, 3 Stangen  
 • Soulever des paniers pour cuiseur a pates CP-94/98, soulèvement temporisé ou manuel, 3 tiges  
 • **Levante cestas para cuece pasta CP-94/98, elevación temporizado o manual, 3 barras cm. 20x90x90h**



0,525 KW 3.634,00  
 230V~ 65 / 0,46  
 50/60 Hz

**SCCPB-92EM** SOLLEVATORE CESTI DA AFFIANCARE AI CUOCIPASTA CPB-98,  
 09140211 sollevamento automatico temporizzato o manuale, 3 aste  
 • Basket elevator for pasta cooker CPB-98, automatic timed or manual lifting, 3 rods  
 • Heben Korbe für Nudelkocher CPB-98, Timed oder manuelle Heben, 3 Stangen  
 • Soulever des paniers pour cuiseur a pates CPB-98, soulèvement temporisé ou manuel, 3 tiges  
 • **Levante cestas para cuece pasta CPB-98, elevación temporizado o manual, 3 barras cm. 20x90x90h**

0,525 KW 3.634,00  
 230V~ 65 / 0,46  
 50/60 Hz

COMBINAZIONI  
 • Combinations / • Zusammenstellungen  
 • Combinaisons / • **Combinación múltiple**



**PI100-98ET** PENTOLA INDIRECTA ELETTRICA LT.100  
 09110831 Vasca Ø cm. 60x42h  
 • Electric indirect boiling pan 100 lts. Tank Ø cm. 60x42h  
 • Indirekter Elektro-Kochkessel lt. 100 Becken Ø cm. 60x42h  
 • Marmite indirecte électrique lt. 100 Cuve Ø cm. 60x42h  
 • **Marmita de calefacción indirecta 100 lt. Cuba Ø cm. 60x42h cm. 80x90x90h**



16 kW 7.418,00  
 400V~3N 107 / 1,2  
 50/60 Hz

**PI100A-98ET** Carico automatico intercapedine  
 0911A831 • Automatic water-charge of double jacket  
 • Automatische Wasserstandskontrolle im Zwischenmantel  
 • Remplissage automatique dans la double paroi  
 • **Carga automática de la camisa intercambiador**

16 kW 9.252,00  
 400V~3N 107 / 1,2  
 50/60 Hz

**PIA100-98ET** PENTOLA INDIRECTA ELETTRICA LT. 100 AUTOCLAVE - Vasca Ø cm. 60x42h  
 09110833 • Electric indirect boiling pan 100 lts. autoclave Tank Ø cm. 60x42h  
 • Indirekter Elektro-Kochkessel 100 lt. Druckkessel Becken Ø cm. 60x42h  
 • Marmite indirecte électrique 100 lt. autoclave Cuve Ø cm. 60x42h  
 • **Marmita de calefacción indirecta 100 lt. autoclave Cuba Ø cm. 60x42h cm. 80x90x90h**

16 kW 8.741,00  
 400V~3N 113 / 1,2  
 50/60 Hz

**PIA100A-98ET** Carico automatico intercapedine  
 0911A833 • Automatic water-charge of double jacket  
 • Automatische Wasserstandskontrolle im Zwischenmantel  
 • Remplissage automatique dans la double paroi  
 • **Carga automática de la camisa intercambiador**

16 kW 10.575,00  
 400V~3N 113 / 1,2  
 50/60 Hz

**PD100-98G** PENTOLA DIRETTA GAS LT.100 Vasca Ø cm. 60x42h  
 09280850 • Gas direct boiling pan 100 lts. Tank Ø cm. 60x42h  
 • Direkter Gas-Kockessel 100 lt. Becken Ø cm. 60x42h  
 • Marmite directe à gaz 100 lt. Cuve Ø cm. 60x42h  
 • **Marmita de calefacción directa lt. 100 Cuba Ø cm. 60x42h cm. 80x90x90h**





21 kW 5.859,00  
 18.060 kcal/h 106 / 1,2

**PDA100-98G** PENTOLA DIRETTA GAS LT. 100 AUTOCLAVE  
 09280852 Vasca Ø cm. 60x42h  
 • Gas direct boiling pan 100 lts. autoclave Tank Ø cm. 60x42h  
 • Direkter Gas-Kockessel 100 lt. Druckkessel Becken Ø cm. 60x42h  
 • Marmite directe à gaz 100 lt. autoclave Cuve Ø cm. 60x42h  
 • **Marmita de calefacción directa lt. 100 autoclave Cuba Ø cm. 60x42h cm. 80x90x90h**

21 kW 7.198,00  
 18.060 kcal/h 111 / 1,2

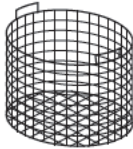
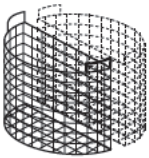
## IPERLOTUS 90

MOD. COD.	DESCRIZIONE/DESCRIPTION/BEZEICHNUNG/DESCRIPTION/DESCRIPCIÓN DIMENSIONI/DIMENSIONS/ABMESSUNGEN/DIMENSIONS/DIMENSIONES	POTENZA/POWER/LEISTUNG/PUISSANCE/POTENCIA VOLTAGGIO/VOLTAGE/SPANNUNG/VOLTAGE/VOLTAJE	$\frac{kW}{kcal/h}$ $\frac{kw}{V_{Hz}}$	PREZZO/PRICE € PREIS/PRIX/PRECIO € KG / M <sup>3</sup>
<b>PI100-98G</b> 09280851	<b>PENTOLA INDIRETTA GAS LT.100</b> Vasca Ø cm. 60x42h • Gas indirect boiling pan 100 lts. Tank Ø cm. 60x42h • Indirekter Gas-Kochkessel 100 lt. Becken Ø cm. 60x42h • Marmite indirecte à gaz 100 lt. Cuve Ø cm. 60x42h • <b>Marmita de calefacción indirecta a gas lt. 100 Cuba Ø cm. 60x42h cm. 80x90x90h</b>		$\frac{21 kW}{18.060 kcal/h}$	<b>7.655,00</b> 131 / 1,2
<b>PI100A-98G</b> 0928A851	Carico automatico intercapedine • Automatic water-charge of double jacket • Automatische Wasserstandskontrolle im Zwischenmantel • Remplissage automatique dans la double paroi • <b>Carga automática de la camisa intercambiador</b>		$\frac{21 kW}{18.060 kcal/h}$ $\frac{0,1 KW}{230V\sim}$ 50/60 Hz	<b>9.640,00</b> 131 / 1,2
<b>PIA100-98G</b> 09280853	<b>PENTOLA INDIRETTA GAS LT. 100 AUTOCLAVE</b> Vasca Ø cm. 60x42h • Gas indirect boiling pan 100 lts. - Autoclave Tank Ø cm. 60x42h • Indirekter Gas-Kochkessel 100 lt. - Druckkessel Becken Ø cm. 60x42h • Marmite indirecte gaz 100 lt. - Autoclave Cuve Ø cm. 60x42h • <b>Marmita de calefacción indirecta 100 lt. - Autoclave Cuba Ø cm. 60x42h cm. 80x90x90h</b>		$\frac{21 kW}{18.060 kcal/h}$	<b>8.978,00</b> 136 / 1,2
<b>PIA100A-98G</b> 0928A853	Carico automatico intercapedine • Automatic water-charge of double jacket • Automatische Wasserstandskontrolle im Zwischenmantel • Remplissage automatique dans la double paroi • <b>Carga automática de la camisa intercambiador</b>		$\frac{21 kW}{18.060 kcal/h}$ $\frac{0,1 KW}{230V\sim}$ 50/60 Hz	<b>10.963,00</b> 136 / 1,2
<b>531043401</b>	OPTIONAL: Cesto 1/1 per pentola 100 LT • Optional: Basket 1/1 for boiling pan • Zubehör: Korb 1/1 für Kochkessel • En option: Panier 1/1 pour marmite • <b>Opcional: Cesta 1/1 por marmita cm. Ø 56x34,5h</b>			<b>945,00</b> 5 / 0,044
<b>531043501</b>	OPTIONAL: Cesto 1/1 per pentola 150 LT • Optional: Basket 1/1 for boiling pan • Zubehör: Korb 1/1 für Kochkessel • En option: Panier 1/1 pour marmite • <b>Opcional: Cesta 1/1 por marmita cm. Ø 56x47h</b>			<b>987,00</b> 5 / 0,044
<b>531043601</b>	OPTIONAL: Cesto 1/2 per pentola 100 LT • Optional: Basket 1/2 for boiling pan • Zubehör: Korb 1/2 für Kochkessel • En option: Panier 1/2 pour marmite • <b>Opcional: Cesta 1/2 por marmita cm. Ø 56x34,5h</b>			<b>578,00</b> 2,5 / 0,022
<b>531043701</b>	OPTIONAL: Cesto 1/2 per pentola 150 LT • Optional: Basket 1/2 for boiling pan • Zubehör: Korb 1/2 für Kochkessel • En option: Panier 1/2 pour marmite • <b>Opcional: Cesta 1/2 por marmita cm. Ø 56x47h</b>			<b>704,00</b> 2,5 / 0,022
<b>ISP</b> 09580020	OPTIONAL: Imbuto per scarico pentole • Optional: Channel for pan drainage • Zubehör: Trichter zum Entleeren der Töpfe • En option: Entonnoir pour vidange marmites • <b>Opcional: Embudo para descargar marmitas</b>			<b>124,00</b> 5 / 0,03

# IPERLOTUS 90

MOD. / COD.	DESCRIZIONE / DESCRIPTION / BEZEICHNUNG / DESCRIPTION / DESCRIPCIÓN / DIMENSIONI / DIMENSIONS / ABMESSUNGEN / DIMENSIONS / DIMENSIONES	POTENZA / POWER / LEISTUNG / PUISSANCE / POTENCIA / VOLTAGGIO / VOLTAGE / SPANNUNG / VOLTAGE / VOLTAJE	$\frac{kW}{kcal/h}$ / $\frac{kW}{V-}$ / Hz PREZZO / PRICE / € / PREIS / PRIX / PRECIO / KG / M <sup>3</sup>
<b>PI150-98ET</b> 09110836	PENTOLA INDIRETTA ELETTRICA LT. 135 Vasca Ø cm. 60x54h • Electric indirect boiling pan 135 lts. Tank Ø cm. 60x54h • Indirekter Elektro-Kochkessel 135 lt. Becken Ø cm. 60x54h • Marmite indirecte électrique 135 lt. Cuve Ø cm. 60x54h • <b>Marmita de calefacción indirecta 135 lt. Cuba Ø cm. 60x54h cm. 80x90x90h</b>	$\frac{18 kW}{400V\sim 3N}$ 50/60 Hz	<b>7.718,00</b> 110 / 1,2
<b>PI150A-98ET</b> 0911A836	Carico automatico intercapedine • Automatic water-charge of double jacket • Automatische Wasserstandskontrolle im Zwischenmantel • Remplissage automatique dans la double paroi • <b>Carga automática de la camisa intercambiador</b>	$\frac{18 kW}{400V\sim 3N}$ 50/60 Hz	<b>9.551,00</b> 110 / 1,2
<b>PIA150-98ET</b> 09110837	PENTOLA INDIRETTA ELETTRICA LT. 135 AUTOCLAVE - Vasca cm. Ø 60x54h • Electric indirect boiling pan 135 lts. - Autoclave Tank Ø cm. 60x54h • Indirekter Elektro-Kochkessel 135 lt. - Druckkessel Becken Ø cm. 60x54h • Marmite indirecte électrique 135 lt. - Autoclave Cuve Ø cm. 60x54h • <b>Marmita de calefacción 135 lt. - Autoclave Cuba Ø cm. 60x54h cm. 80x90x90h</b>	$\frac{18 kW}{400V\sim 3N}$ 50/60 Hz	<b>9.072,00</b> 116 / 1,2
<b>PIA150A-98ET</b> 0911A837	Carico automatico intercapedine • Automatic water-charge of double jacket • Automatische Wasserstandskontrolle im Zwischenmantel • Remplissage automatique dans la double paroi • <b>Carga automática de la camisa intercambiador</b>	$\frac{18 kW}{400V\sim 3N}$ 50/60 Hz	<b>10.905,00</b> 116 / 1,2
<b>PD150-98G</b> 09280854	PENTOLA DIRETTA GAS LT. 140 Vasca Ø cm. 60x54h • Gas direct boiling pan 140 lts. Tank Ø cm. 60x54h • Direkter Gas-Kochkessel 140 lt. Becken Ø cm. 60x54h • Marmite directe à gaz 140 lt. Cuve Ø cm. 60x54h • <b>Marmita de calefacción directa lt. 140 Cuba Ø cm. 60x54h cm. 80x90x90h</b>	$\frac{21 kW}{18.060 kcal/h}$	<b>6.001,00</b> 108 / 1,2
<b>PDA150-98G</b> 09280855	PENTOLA DIRETTA GAS LT. 140 AUTOCLAVE Vasca Ø cm. 60x54h • Gas direct boiling pan 140 lts. - Autoclave Tank Ø cm. 60x54h • Direkter Gas-Kochkessel 140 lt. - Druckkessel Becken Ø cm. 60x54h • Marmite directe à gaz 140 lt. - Autoclave Cuve Ø cm. 60x54h • <b>Marmita de calefacción directa lt. 140 - Autoclave Cuba Ø cm. 60x54h cm. 80x90x90h</b>	$\frac{21 kW}{18.060 kcal/h}$	<b>7.355,00</b> 113 / 1,2
<b>PI150-98G</b> 09280856	PENTOLA INDIRETTA GAS LT. 135 Vasca Ø cm. 60x54h • Gas indirect boiling pan 135 lts. Tank Ø cm. 60x54h • Indirekter Gas-Kochkessel 135 lt. Becken Ø cm. 60x54h • Marmite indirecte à gaz 135 lt. Cuve Ø cm. 60x54h • <b>Marmita de calefacción Indirecta lt. 135 Cuba Ø cm. 60x54h cm. 80x90x90h</b>	$\frac{21 kW}{18.060 kcal/h}$	<b>7.922,00</b> 135 / 1,2
<b>PI150A-98G</b> 0928A856	Carico automatico intercapedine • Automatic water-charge of double jacket • Automatische Wasserstandskontrolle im Zwischenmantel • Remplissage automatique dans la double paroi • <b>Carga automática de la camisa intercambiador</b>	$\frac{21 kW}{18.060 kcal/h}$ $\frac{0,1 KW}{230V\sim}$ 50/60 Hz	<b>9.908,00</b> 135 / 1,2
<b>PIA150-98G</b> 09280857	PENTOLA INDIRETTA GAS LT. 135 AUTOCLAVE Vasca Ø cm. 60x54h • Gas indirect boiling pan 135 lts. - Autoclave Tank Ø cm. 60x54h • Indirekter Gas-Kochkessel 135 lt. - Druckkessel Becken Ø cm. 60x54h • Marmite indirecte électrique à gaz 135 lt. - Autoclave Cuve Ø cm. 60x54h • <b>Marmita de calefacción indirecta a gas 135 lt. - Autoclave Cuba Ø cm. 60x54h cm. 80x90x90h</b>	$\frac{21 kW}{18.060 kcal/h}$	<b>9.277,00</b> 115 / 1,2
<b>PIA150A-98G</b> 0928A857	Carico automatico intercapedine • Automatic water-charge of double jacket • Automatische Wasserstandskontrolle im Zwischenmantel • Remplissage automatique dans la double paroi • <b>Carga automática de la camisa intercambiador</b>	$\frac{21 kW}{18.060 kcal/h}$ $\frac{0,1 KW}{230V\sim}$	<b>11.262,00</b> 115 / 1,2

## IPERLOTUS 90

MOD. COD.	DESCRIZIONE/DESCRIPTION/BEZEICHNUNG/DESCRIPTION/DESCRIPCIÓN DIMENSIONI/DIMENSIONS/ABMESSUNGEN/DIMENSIONS/DIMENSIONES	POTENZA/POWER/LEISTUNG/PUISSANCE/POTENCIA VOLTAGGIO/VOLTAGE/SPANNUNG/VOLTAGE/VOLTAJE	$\frac{kW}{kcal/h}$ $\frac{kw}{V}$ Hz	PREZZO/PRICE € PREIS/PRIX/PRECIO € KG / M <sup>3</sup>
<b>FTL-94ET</b> 09060431 □	FRY-TOP LISCIO TRIFASE SU MOBILE A GIORNO Piastra cm. 36x68 • Smooth griddle threephase on open cabinet Plate cm. 36x68 • Griddleplatte glatt dreiphasig mit offenem Unterbau Platte cm. 36x68 • Plaque lisse triphase sur armoire ouvert Plaque cm. 36x68 • <b>Fry-top trifásico sobre mueble abierto</b> <b>Plancha cm. 36x68</b>		$\frac{7,5 kW}{400V \sim 3N}$ 50/60 Hz	<b>2.127,00</b> 79 / 0,46
<b>FTR-94ET</b> 09060433 ▨	FRY-TOP RIGATO TRIFASE SU MOBILE A GIORNO Piastra cm. 36x68 • Grooved griddle threephase on open cabinet Plate cm. 36x68 • Griddleplatte gerillt dreiphasig mit offenem Unterbau Platte cm. 36x68 • Plaque nervurée triphase sur armoire ouvert Plaque cm. 36x68 • <b>Fry-top estriado trifásico sobre mueble abierto</b> <b>Plancha cm. 36x68</b>			<b>2.279,00</b> 79 / 0,46
<b>FTL-94ETS</b> 09060434 □	FRY-TOP LISCIO CROMATO TRIFASE SU MOBILE A GIORNO Piastra cm. 36x68 • Chromed smooth griddle threephase on open cabinet Plate cm. 36x68 • Griddleplatte glatt hartverchromt dreiphasig mit offenem Unterbau Platte cm. 36x68 • Plaque lisse chromée triphase sur armoire ouvert Plaque cm. 36x68 • <b>Fry-top liso cromado trifásico sobre mueble abierto</b> <b>Plancha cm. 36x68</b>			<b>2.522,00</b> 79 / 0,46
<b>FTR-94ETS</b> 09060436 ▨	FRY-TOP RIGATO CROMATO TRIFASE SU MOBILE A GIORNO Piastra cm. 36x68 • Grooved chromed griddle threephase on open cabinet Plate cm. 36x68 • Griddleplatte gerillt hartverchromt dreiphasig mit offenem Unterbau Platte cm. 36x68 • Plaque nervurée chromée triphase sur armoire ouvert Plaque cm. 36x68 • <b>Fry-top estriado cromado trifásico sobre mueble abierto</b> <b>Plancha cm. 36x68</b> <b>cm. 40x90x90h</b>			<b>2.669,00</b> 79 / 0,46
<b>FTL-94G</b> 09230451 □	FRY-TOP LISCIO GAS SU MOBILE A GIORNO Piastra cm. 36x68 • Smooth griddle gas on open cabinet Plate cm. 36x68 • Gas-Griddleplatte glatt mit offenem Unterbau Platte cm. 36x68 • Plaque lisse gaz sur armoire ouvert Plaque cm. 36x68 • <b>Fry-top liso gas sobre mueble abierto</b> <b>Plancha cm. 36x68</b>		$\frac{9 kW}{7.740 kcal/h}$	<b>2.095,00</b> 81 / 0,46
<b>FTR-94G</b> 09230453 ▨	FRY-TOP RIGATO GAS SU MOBILE A GIORNO Piastra cm. 36x68 • Grooved griddle gas on open cabinet Plate cm. 36x68 • Gas-Griddleplatte gerillt mit offenem Unterbau Platte cm. 36x68 • Plaque nervurée gaz sur armoire ouvert Plaque cm. 36x68 • <b>Fry-top estriado gas sobre mueble abierto</b> <b>Plancha cm. 36x68</b>			<b>2.242,00</b> 81 / 0,46
<b>FTL-94GS</b> 09230454 □	FRY-TOP LISCIO CROMATO GAS SU MOBILE A GIORNO Piastra cm. 36x68 • Chromed smooth griddle gas on open cabinet Plate cm. 36x68 • Gas-Griddleplatte glatt hartverchromt mit offenem Unterbau Platte cm. 36x68 • Plaque lisse chromée gaz sur armoire ouvert Plaque cm. 36x68 • <b>Fry-top liso cromado gas sobre mueble abierto</b> <b>Plancha cm. 36x68</b>			<b>2.512,00</b> 81 / 0,46
<b>FTR-94GS</b> 09230456 ▨	FRY-TOP RIGATO CROMATO GAS SU MOBILE A GIORNO Piastra cm. 36x68 • Chromed grooved griddle gas on open cabinet Plate cm. 36x68 • Gas-Griddleplatte gerillt hartverchromt mit offenem Unterbau Platte cm. 36x68 • Plaque nervurée chromée gaz sur armoire ouvert Plaque cm. 36x68 • <b>Fry-top estriado cromado gas sobre mueble abierto</b> <b>Plancha cm. 36x68</b> <b>cm. 40x90x90h</b>			<b>2.660,00</b> 81 / 0,46



# IPERLOTUS 90

MOD. \_\_\_\_\_ DESCRIZIONE/DESCRIPTION/BEZEICHNUNG/DESCRIPTION/DESCRIPCIÓN POTENZA/POWER/LEISTUNG/PUISSANCE/POTENCIA ⚡kW ⚡kw PREZZO/PRICE €  
 COD. \_\_\_\_\_ DIMENSIONI/DIMENSIONS/ABMESSUNGEN/DIMENSIONS/DIMENSIONES VOLTAGGIO/VOLTAGE/SPANUNNG/VOLTAGE/VOLTAJE kcal/h V~ Hz PREIS/PRIX/PRECIO €  
 KG / M<sup>3</sup>

**FTL-98ET**  
09060831



**FRY-TOP LISCIO TRIFASE SU MOBILE A GIORNO**  
 Piastra cm. 76x68 - 2 zone di cottura  
 • Smooth griddle threephase on open cabinet  
 Platte cm. 76x68 - 2 cooking areas  
 • Griddleplatte glatt dreiphasig mit offenem Unterbau  
 Platte cm. 76x68 - 2 Heizzonen  
 • Plaque lisse triphase sur armoire ouvert  
 Plaque cm. 76x68 - 2 zones de cuisson  
 • **Fry-top trifásico sobre mueble abierto**  
**Plancha cm. 76x68 - 2 zonas de cocción**



⚡ 15 kW **3.094,00**  
 400V~3N 126 / 0,88  
 50/60 Hz

**FTLR-98ET**  
09060832



**FRY-TOP 1/2 LISCIO +1/2 RIGATO TRIFASE SU MOBILE A GIORNO**  
 Piastra cm. 76x68 - 2 zone di cottura  
 • 1/2 sm. +1/2 gr. griddle threephase on open cabinet  
 Platte cm. 76x68 - 2 cooking areas  
 • Griddleplatte 1/2 glatt +1/2 gerillt dreiphasig mit offenem Unterbau  
 Platte cm. 76x68 - 2 Heizzonen  
 • Plaque 1/2 lisse + 1/2 nervurée triphase sur armoire ouvert  
 Plaque cm. 76x68 - 2 zones de cuisson  
 • **Fry-top 1/2 liso + 1/2 estriado trifásico sobre mueble abierto**  
**Plancha cm. 76x68 - 2 zonas de cocción**

**3.276,00**  
126 / 0,88

**FTR-98ET**  
09060833



**FRY-TOP RIGATO TRIFASE SU MOBILE A GIORNO**  
 Piastra cm. 76x68 - 2 zone di cottura  
 • Grooved griddle threephase on open cabinet  
 Platte cm. 76x68 - 2 cooking areas  
 • Griddleplatte gerillt dreiphasig mit offenem Unterbau  
 Platte cm. 76x68 - 2 Heizzonen  
 • Plaque nervurée triphase sur armoire ouvert  
 Plaque cm. 76x68 - 2 zones de cuisson  
 • **Fry-top estriado trifásico sobre mueble abierto**  
**Plancha cm. 76x68 - 2 zonas de cocción**

**3.456,00**  
126 / 0,88

**FTL-98ETS**  
09060834



**FRY-TOP LISCIO CROMATO TRIFASE SU MOBILE A GIORNO**  
 Piastra cm. 76x68 - 2 zone di cottura  
 • Chromed smooth griddle threephase on open cabinet  
 Platte cm. 76x68 - 2 cooking areas  
 • Griddleplatte glatt hartverchromt dreiphasig mit offenem Unterbau  
 Platte cm. 76x68 - 2 Heizzonen  
 • Plaque lisse chromée triphase sur armoire ouvert  
 Plaque cm. 76x68 - 2 zones de cuisson  
 • **Fry-top liso cromado trifásico sobre mueble abierto**  
**Plancha cm. 76x68 - 2 zonas de cocción**

**3.683,00**  
126 / 0,88

**FTLR-98ETS**  
09060835



**FRY-TOP 1/2 LISCIO +1/2 RIGATO CROMATO TRIFASE SU MOBILE A GIORNO**  
 Piastra cm. 76x68 - 2 zone di cottura  
 • 1/2 sm. + 1/2 gr. chromed griddle threephase on open cabinet  
 Platte cm. 76x68 - 2 cooking areas  
 • Griddleplatte 1/2 gl + 1/2 ge hartverchromt dreiphasig mit offenem Unterbau  
 Platte cm. 76x68 - 2 Heizzonen  
 • Plaque 1/2 lisse +1/2 nervurée chromée triphase sur armoire ouvert  
 Plaque cm. 76x68 - 2 zones de cuisson  
 • **Fry-top 1/2 liso +1/2 estriado cromado trifásico sobre mueble abierto**  
**Plancha cm. 76x68 - 2 zonas de cocción**

**3.861,00**  
126 / 0,88

**FTR-98ETS**  
09060836









**FRY-TOP RIGATO CROMATO TRIFASE SU MOBILE A GIORNO**  
 Piastra cm. 76x68 - 2 zone di cottura  
 • Grooved chromed griddle threephase on open cabinet  
 Platte cm. 76x68 - 2 cooking areas  
 • Griddleplatte gerillt hartverchromt dreiphasig mit offenem Unterbau  
 Platte cm. 76x68 - 2 Heizzonen  
 • Plaque nervurée chromée triphase sur armoire ouvert  
 Plaque cm. 76x68 - 2 zones de cuisson  
 • **Fry-top estriado cromado trifásico sobre mueble abierto**  
**Plancha cm. 76x68 - 2 zonas de cocción**  
**cm. 80x90x90h**

**4.039,00**  
126 / 0,88



# IPERLOTUS 90

MOD. COD.	DESCRIZIONE/DESCRIPTION/BEZEICHNUNG/DESCRIPTION/DESCRIPCIÓN DIMENSIONI/DIMENSIONS/ABMESSUNGEN/DIMENSIONS/DIMENSIONES	POTENZA/POWER/LEISTUNG/PUISSANCE/POTENCIA VOLTAGGIO/VOLTAGE/SPANNUNG/VOLTAGE/VOLTAJE	$\frac{kW}{kcal/h}$ $\frac{kw}{V-Hz}$	PREZZO/PRICE € PREIS/PRIX/PRECIO € KG / M <sup>3</sup>
<b>FTL-98G</b> 09230851 	<b>FRY-TOP LISCIO GAS SU MOBILE A GIORNO</b> Piastra cm. 76x68 - 2 zone di cottura • Smooth griddle gas on open cabinet Plate cm. 76x68 - 2 cooking areas • Gas-Griddleplatte mit offenem Unterbau Platte cm. 76x68 - 2 Heizzonen • Plaque lisse gaz sur armoire ouvert Plaque cm. 76x68 - 2 zones de cuisson • <b>Fry-top liso gas sobre mueble abierto</b> <b>Plancha cm. 76x68 - 2 zonas de cocción</b>		$\frac{18}{15.480}$ $\frac{kW}{kcal/h}$	<b>3.204,00</b> 134 / 0,88
				
<b>FTLR-98G</b> 09230852 	<b>FRY-TOP 1/2 LISCIO + 1/2 RIGATO GAS SU MOBILE A GIORNO</b> Piastra cm. 76x68 - 2 zone di cottura • 1/2 sm. + 1/2 gr. griddle gas on open cabinet Plate cm. 76x68 - 2 cooking areas • Gas-Griddleplatte 1/2 glatt + 1/2 gerillt mit offenem Unterbau Platte cm. 76x68 - 2 Heizzonen • Plaque 1/2 lisse + 1/2 nervurée gaz sur armoire ouvert Plaque cm. 76x68 - 2 zones de cuisson • <b>Fry-top 1/2 liso + 1/2 estriado gas sobre mueble abierto</b> <b>Plancha cm. 76x68 - 2 zonas de cocción</b>			<b>3.353,00</b> 134 / 0,88
<b>FTR-98G</b> 09230853 	<b>FRY-TOP RIGATO GAS SU MOBILE A GIORNO</b> Piastra cm. 76x68 - 2 zone di cottura • Grooved griddle gas on open cabinet Plate cm. 76x68 - 2 cooking areas • Gas-Griddleplatte gerillt mit offenem Unterbau Platte cm. 76x68 - 2 Heizzonen • Plaque nervurée electriques sur armoire ouvert Plaque cm. 76x68 - 2 zones de cuisson • <b>Fry-top estriado gas sobre mueble abierto</b> <b>Plancha cm. 76x68 - 2 zonas de cocción</b>			<b>3.509,00</b> 134 / 0,88
<b>FTL-98GS</b> 09230854 	<b>FRY-TOP LISCIO CROMATO GAS SU MOBILE A GIORNO</b> Piastra cm. 76x68 - 2 zone di cottura • Chrome smooth griddle gas on open cabinet Plate cm. 76x68 - 2 cooking areas • Gas-Griddleplatte glatt hartverchromt mit offenem Unterbau Platte cm. 76x68 - 2 Heizzonen • Plaque lisse chromée gaz sur armoire ouvert Plaque cm. 76x68 - 2 zones de cuisson • <b>Fry-top liso cromado gas sobre mueble abierto</b> <b>Plancha cm. 76x68 - 2 zonas de cocción</b>			<b>3.938,00</b> 134 / 0,88
<b>FTLR-98GS</b> 09230855 	<b>FRY-TOP 1/2 LISCIO + 1/2 RIGATO CROMATO GAS SU MOBILE A GIORNO</b> Piastra cm. 76x68 - 2 zone di cottura • 1/2 smooth + 1/2 grooved chromed griddle gas On open cabinet Plate cm. 76x68 - 2 cooking areas • Gas-Griddleplatte 1/2 glatt + 1/2 gerillt hartverchromt Mit offenem Unterbau Platte cm. 76x68 - 2 Heizzonen • Plaque 1/2 lisse + 1/2 nervurée chromée gaz Sur armoire ouvert Plaque cm. 76x68 - 2 zones de cuisson • <b>Fry-top 1/2 liso + 1/2 estriado cromado gas</b> <b>Sobre mueble abierto Plancha cm. 76x68 - 2 zonas de cocción</b>			<b>4.121,00</b> 134 / 0,88
<b>FTR-98GS</b> 09230856 	<b>FRY-TOP RIGATO CROMATO GAS SU MOBILE A GIORNO</b> Piastra cm. 76x68 - 2 zone di cottura • Grooved chromed griddle gas on open cabinet Plate cm. 76x68 - 2 cooking areas • Gas-Griddleplatte gerillt hartverchromt mit offenem Unterbau Platte cm. 76x68 - 2 Heizzonen • Plaque nervurée chromée gaz sur armoire ouvert Plaque cm. 76x68 - 2 zones de cuisson • <b>Fry-top estriado cromado gas sobre mueble abierto</b> <b>Plancha cm. 76x68 - 2 zonas de cocción</b> <b>cm. 80x90x90h</b>			<b>4.306,00</b> 134 / 0,88

## IPERLOTUS 90

MOD. / COD.	DESCRIZIONE / DESCRIPTION / BEZEICHNUNG / DESCRIPTION / DESCRIPCIÓN / DIMENSIONI / DIMENSIONS / ABMESSUNGEN / DIMENSIONS / DIMENSIONES	POTENZA / POWER / LEISTUNG / PUISSANCE / POTENCIA / VOLTAGGIO / VOLTAGE / SPANNUNG / VOLTAGE / VOLTAGE	$\frac{kW}{kcal/h}$ / $\frac{kW}{V}$ / $\frac{Hz}{Hz}$	PREZZO / PRICE / PREIS / PRIX / PRECIO / KG / M <sup>2</sup>
<b>FTC-94ET</b> 09060437	<p>FRY-TOP VETROCERAMICA TRIFASE SU MOBILE A GIORNO Piastra cm. 36x68</p> <ul style="list-style-type: none"> <li>Griddle ceramic glass threephase on open cabinet Plate cm. 36x68</li> <li>Griddleplatte dreiphasig Kochfläche mit offenem Unterbau Platte cm. 36x68</li> <li>Rechaud triphase vitrocéramique sur armoire ouvert Plaque cm. 36x68</li> <li><b>Fry-top vitroceramica trifasico sobre mueble abierto Plancha cm. 36x68 cm. 40x90x90h</b></li> </ul>		$\nearrow$ 3,5 kW 400V~3N 230V~3 230V~ 50/60 Hz	<b>3.061,00</b> 78 / 0,46
<b>FTC-98ET</b> 09060837	<p>FRY-TOP VETROCERAMICA TRIFASE SU MOBILE A GIORNO Piastra cm. 76x68 - 2 zone di cottura</p> <ul style="list-style-type: none"> <li>Griddle ceramic glass threephase on open cabinet Plate cm. 76x68 - 2 cooking areas</li> <li>Griddleplatte dreiphasig Kochfläche mit offenem Unterbau Platte cm. 76x68 - 2 Heizzonen</li> <li>Rechaud triphase vitrocéramique sur armoire ouvert Plaque cm. 76x68 - 2 zones de cuisson</li> <li><b>Fry-top vitroceramica trifasico sobre mueble abierto Plancha cm. 76x68 - 2 zonas de cocción cm. 80x90x90h</b></li> </ul>		$\nearrow$ 7 kW 400V~3N 230V~3 230V~ 50/60 Hz	<b>5.061,00</b> 109 / 0,88
<b>FTL-916ET</b> 09061631	<p>FRY-TOP LISCIO TRIFASE SU MOBILE A GIORNO Piastra cm. 150,5x65 - 4 zone di cottura</p> <ul style="list-style-type: none"> <li>Smooth griddle threephase on open cabinet Plate cm. 150,5x65 - 4 cooking areas</li> <li>Griddleplatte glatt dreiphasig mit offenem Unterbau Platte cm. 150,5x65 - 4 Heizzonen</li> <li>Plaque lisse triphase sur armoire ouvert Plaque cm. 150,5x65 - 4 zones de cuisson</li> <li><b>Fry-top trifásico sobre mueble abierto Plancha cm. 150,5x65 - 4 zonas de cocción</b></li> </ul>		$\nearrow$ 30 kW 400V~3N 50/60 Hz	<b>6.305,00</b> 256 / 1,86
<b>FTL-916ETS</b> 09061634	<p>FRY-TOP LISCIO CROMATO TRIFASE SU MOBILE A GIORNO Piastra cm. 150,5x65 - 4 zone di cottura</p> <ul style="list-style-type: none"> <li>Chromed smooth griddle threephase on open cabinet Plate cm. 150,5x65 - 4 cooking areas</li> <li>Griddleplatte glatt hartverchromt dreiphasig mit offenem Unterbau Platte cm. 150,5x65 - 4 Heizzonen</li> <li>Plaque lisse chromée triphase sur armoire ouvert Plaque cm. 150,5x65 - 4 zones de cuisson</li> <li><b>Fry-top liso cromado trifásico sobre mueble abierto Plancha cm. 150,5x65 - 4 zonas de cocción cm. 160x90x90h</b></li> </ul>			<b>7.193,00</b> 256 / 1,86
<b>FTL-916G</b> 09231651	<p>FRY-TOP LISCIO GAS SU MOBILE A GIORNO Piastra cm. 150,5x65 - 4 zone di cottura</p> <ul style="list-style-type: none"> <li>Smooth griddle gas on open cabinet Plate cm. 150,5x65 - 4 cooking areas</li> <li>Gas-Griddleplatte mit offenem Unterbau Platte cm. 150,5x65 - 4 Heizzonen</li> <li>Plaque lisse gaz sur armoire ouvert Plaque cm. 150,5x65 - 4 zones de cuisson</li> <li><b>Fry-top liso gas sobre mueble abierto Plancha cm. 150,5x65 - 4 zonas de cocción</b></li> </ul>		$\nearrow$ 36 kW 30.960 kcal/h	<b>6.413,00</b> 266 / 1,86
<b>FTL-916GS</b> 09231654	<p>FRY-TOP LISCIO CROMATO GAS SU MOBILE A GIORNO Piastra cm. 150,5x65 - 4 zone di cottura</p> <ul style="list-style-type: none"> <li>Chrome smooth griddle gas on open cabinet Plate cm. 150,5x65 - 4 cooking areas</li> <li>Gas-Griddleplatte glatt hartverchromt mit offenem Unterbau Platte cm. 150,5x65 - 4 Heizzonen</li> <li>Plaque lisse chromée gaz sur armoire ouvert Plaque cm. 150,5x65 - 4 zones de cuisson</li> <li><b>Fry-top liso cromado gas sobre mueble abierto Plancha cm. 150,5x65 - 4 zonas de cocción cm. 160x90x90h</b></li> </ul>			<b>7.332,00</b> 266 / 1,86



## IPERLOTUS 90

MOD. COD.	DESCRIZIONE / DESCRIPTION / BEZEICHNUNG / DESCRIPCIÓN DIMENSIONI / DIMENSIONS / ABMESSUNGEN / DIMENSIONES	POTENZA / POWER / LEISTUNG / PUISSANCE / POTENCIA VOLTAGGIO / VOLTAGE / SPANNUNG / VOLTAGE / VOLTAGE	⚡ kW kcal/h	⚡ kw V~ Hz	PREZZO / PRICE € PREIS / PRIX / PRECIO € KG / M <sup>3</sup>
<b>CW-94ET</b> 09080430	<p>GRIGLIA TRIFASE SU MOBILE A GIORNO Griglia in acciaio inox cm. 38x66 regolabile</p> <ul style="list-style-type: none"> <li>• Grill threephase on open cabinet Stainless steel adjustable grill cm. 38x66</li> <li>• Wurstbrater dreiphasig mit offenem Unterbau Einstellbarer Rost aus Nirosta cm. 38x66</li> <li>• Grillade triphase sur armoire ouvert Grille réglable en acier inox cm 38x66</li> <li>• <b>Parrilla trifásico sobre mueble abierto Parrilla de acero inox regulable cm 38x66 cm. 40x90x90h</b></li> </ul>		7,8 kW 400V~3N 50/60 Hz		<b>2.328,00</b> 71 / 0,46
<b>CW-94G</b> 09250450	<p>GRIGLIA GAS-PIETRALAVICA SU MOBILE A GIORNO Griglia in acciaio inox cm. 38x66 regolabile</p> <ul style="list-style-type: none"> <li>• Charcoal grill gas on open cabinet - Stainless steel adjustable grill cm. 38x66</li> <li>• Gas-Lavasteingrill mit offenem Unterbau - Einstellbarer Rost aus Nirosta cm. 38x66</li> <li>• Grille a gaz en pierre de lave sur armoire ouvert - Grille réglable en acier inox cm. 38x66</li> <li>• <b>Parrilla a gas piedra lávica sobre mueble abierto - Parrilla de acero inox regulable 38x66 cm cm. 40x90x90h</b></li> </ul>		12 kW 10.320 kcal/h		<b>2.267,00</b> 77 / 0,46
<b>CW-98ET</b> 09080830	<p>GRIGLIA TRIFASE SU MOBILE A GIORNO N. 2 griglie in acciaio inox cm. 38x66 regolabili 2 zone di cottura</p> <ul style="list-style-type: none"> <li>• Grill threephase on open cabinet - N. 2 stainless steel adjustable grills cm. 38x66 - 2 cooking areas</li> <li>• Wurstbrater dreiphasig mit offenem Unterbau - N. 2 einstellbarer Roste aus Nirosta cm. 38x66 - 2 Heizzonen</li> <li>• Grillade triphase sur armoire ouvert - N. 2 grilles réglable en acier inox cm. 38x66 - 2 zones de cuisson</li> <li>• <b>Parrilla trifásico sobre mueble abierto - N. 2 parrillas de acero inox regulable cm 38x66 - 2 zonas de coccion cm. 80x90x90h</b></li> </ul>		15,6 kW 400V~3N 50/60 Hz		<b>3.437,00</b> 109 / 0,88
<b>CW-98G</b> 09250850	<p>GRIGLIA GAS-PIETRALAVICA SU MOBILE A GIORNO N. 2 griglie in acciaio inox cm. 38x66 regolabili 2 zone di cottura</p> <ul style="list-style-type: none"> <li>• Charcoal grill gas on open cabinet - N. 2 stainless steel adjustable grills cm. 38x66 - 2 cooking areas</li> <li>• Gas-Lavasteingrill mit offenem Unterbau - N. 2 einstellbarer Roste aus Nirosta cm. 38x66 - 2 Heizzonen</li> <li>• Grille à gaz en pierre de lave sur armoire ouvert N. 2 grilles en acier inox cm 38x66 - 2 zones de cuisson</li> <li>• <b>Parrilla a gas piedra lávica sobre mueble abierto N. 2 parrilla de acero inox regulable cm 38x66 - 2 zonas de coccion cm. 80x90x90h</b></li> </ul>		24 kW 20.640 kcal/h		<b>3.525,00</b> 131 / 0,88
<b>CWK-94ET</b> 09080431	<p>GRIGLIA CONTACT SU MOBILE A GIORNO - cottura diretta su resistenza in acciaio inox cm. 27x63 ribaltabile</p> <ul style="list-style-type: none"> <li>• CONTACT Grill threephase on open cabinet - rotatable stainless steel grill cm. 27x63</li> <li>• Wurstbrater dreiphasig KONTAKT mit offenem Unterbau - Drehbaren Heizelement aus Edelstahl cm. 27x63</li> <li>• Grillade triphase CONTACT sur armoire ouvert- Grille inox rotatif cm 27x63</li> <li>• <b>Parrilla trifásico CONTACT sobre mueble abierto - Parrilla giratoria de acero inox cm 27x63 cm. 40x90x90h</b></li> </ul>		5,415 kW 400V~3N 50/60 Hz		<b>2.988,00</b> 69 / 0,46
<b>CWK-98ET</b> 09080831	<p>GRIGLIA CONTACT SU MOBILE A GIORNO - cottura diretta su resistenza in acciaio inox cm. 55x63 ribaltabile - 2 zone di cottura</p> <ul style="list-style-type: none"> <li>• CONTACT Grill threephase on open cabinet - rotatable stainless steel grill cm. 55x63 - 2 cooking areas</li> <li>• Wurstbrater dreiphasig KONTAKT mit offenem Unterbau - Drehbaren Heizelement aus Edelstahl cm. 55x63 - 2 Heizzonen</li> <li>• Grillade triphase CONTACT sur armoire ouvert- Grille inox rotatif cm 55x63 - 2 zones de cuisson</li> <li>• <b>Parrilla trifásico CONTACT sobre mueble abierto - Parrilla giratoria de acero inox cm 55x63 - 2 zonas de coccion</b></li> </ul>		10,83 kW 400V~3N 50/60 Hz		<b>4.097,00</b> 105 / 0,88

# IPERLOTUS 90

MOD. / COD.	DESCRIZIONE / DESCRIPTION / BEZEICHNUNG / DESCRIPTION / DESCRIPCIÓN / DIMENSIONI / DIMENSIONS / ABMESSUNGEN / DIMENSIONS / DIMENSIONES	POTENZA / POWER / LEISTUNG / PUISSANCE / POTENCIA / VOLTAGGIO / VOLTAGE / SPANNUNG / VOLTAGE / VOLTAJE	⚡ kW / kcal/h V~ Hz	PREZZO / PRICE / PREIS / PRIX / PRECIO / KG / M <sup>3</sup>
<b>F18-94ET</b> 09090430	FRIGGITRICE TRIFASE LT. 18 Vasca cm. 31x34x33h 1 cesto cm. 28x29x15h Coperchio vasca - Prod. patate: 15 kg/h • Fryer threephase 18 lts. - Bowl cm. 31x34x33h 1 basket cm. 28x29x15h - Lid for pan - Production: 15 kg/h • Friteuse dreiphasisig lt. 18 - Becken cm. 31x34x33h 1 Korb cm. 28x29x15h - Deckel für Becken - Pommes frites: 15 kg/h • Friteuse triphase lt. 18 - Cuve cm. 31x34x33h 1 Panier cm. 28x29x15h Couvercle pour cuve - Production de pommes frites: 15 kg/h • <b>Freidoras trifásico 18 lt. - Cuba cm. 31x34x33h 1 cesta cm. 28x29x15h - Tapa para cuba Producción patatas: 15 Kg/h cm. 40x90x90h</b>		⚡ 15,9 kW 400V~3N 50/60 Hz	<b>2.565,00</b> 63 / 0,46
<b>F25-94ET</b> 09090431	FRIGGITRICE TRIFASE LT. 25 Vasca cm. 31x51x33h - 2 cesti cm. 13,5x45x15h Coperchio vasca - Prod. patate: 25 kg/h • Fryer threephase 25 lts. - Bowl cm. 31x51x33h 2 baskets cm. 13,5x45x15h - Lid for tank Production: 25 kg/h • Friteuse dreiphasisig lt. 25 - Becken cm. 31x51x33h 2 Körbe cm. 13,5x45x15h - Deckel für Becken Pommes frites: 25 kg/h • Friteuse triphase lt. 25 - Cuve cm. 31x51x33h 2 Paniers cm. 13,5x45x15h - Couvercle pour cuve Production de pommes frites: 25 kg/h • <b>Freidoras trifásico 25 lt. - Cuba cm. 31x51x33h 2 cestas cm. 13,5x45x15h - Tapa para cuba Producción patatas: 25 Kg/h cm. 40x90x90h</b>		⚡ 22 kW 400V~3N 50/60 Hz	<b>2.810,00</b> 66 / 0,46
<b>F2/8-94ET</b> 09090432	FRIGGITRICE TRIFASE LT. 8+8 2 Vasche cm. 14,8x35x32,7h 2 cesti cm. 12x30x15h - Filtro e coperchio vasca. Produzione patate: 12 kg/h • Fryer threephase 8+8 lts - 2 Bowls cm. 14,8x35x32,7h - 2 baskets cm. 12x30x15h. Sieve and lid for pan. Production: 12 kg/h • Friteuse dreiphasisig lt. 8+8 - 2 Becken cm. 14,8x35x32,7h - 2 Korb cm. 12x30x15h. Einlegesieb und Deckel für Becken. Pommes frites: 12 kg/h • Friteuse triphase lt. 8+8 - 2 Cuve cm. 14,8x35x32,7h - 2 Panier cm. 12x30x15h. Filtre, couvercle pour cuve. Production de pommes frites: 12 kg/h • <b>Freidoras trifásico 8+8 lt. - 2Cuba cm. 14,8x35x32,7h - 2 cesta cm. 12x30x15hh. Filtro y tapa para cuba. Prod. patatas: 12 Kg/h cm. 40x90x90h</b>		⚡ 12 kW 400V~3N 230V~3 50/60 Hz	<b>3.263,00</b> 63 / 0,46
<b>F2/8-94G</b> 09260452	FRIGGITRICE GAS LT. 8+8 - 2 vasche cm. 15x35x36h 2 cesti cm. 12x30x15h. Filtro e coperchio vasca. Prod. patate: 12 kg/h • Gas Fryer 8+8 lts - 2 pans cm. 15x35x36h 2 baskets cm. 12x30x15h. Sieve and lid for pan. Production: 12 kg/h • Gas-Friteuse lt. 8+8 - 2 Becken cm. 15x35x36h 2 Körbe cm. 12x30x15h. Einlegesieb und Deckel für Becken. Pommes frites: 12 kg/h • Friteuse à gaz lt. 8+8 - 2 cuves cm. 15x35x36h 2 paniers cm. 12x30x15h. Filtre, couvercle pour cuve. Production de pommes frites: 12 kg/h • <b>Freidoras a gas 8+8 lt. - 2 cubas cm. 15x35x36h 2 cestas cm. 12x30x15h. Filtro y tapa para cuba. Prod. patatas: 12 Kg/h cm. 40x90x90h</b>		⚡ 10 kW 8.600 kcal/h	<b>3.752,00</b> 63 / 0,46
<b>F18-94G</b> 09260450	FRIGGITRICE GAS LT. 18 Vasca cm. 24x51x44h - 1 cesto cm. 21x45x15h Coperchio vasca - Prod. patate: 15 kg/h • Gas fryer 18 lts. - Bowl cm. 24x51x44h 1 basket cm. 21x45x15h - Lid for tank Production: 15 kg/h • Gas-Friteuse lt. 18 - Becken cm. 24x51x44h 1 Korb cm. 21x45x15h - Deckel für Becken Pommes frites: 15 kg/h • Friteuse à gaz lt. 18 - Cuve cm. 24x51x44h 1 Panier cm. 21x45x15h - Couvercle pour cuve Production de pommes frites: 15 kg/h • <b>Freidoras a gas 18 lt. - Cuba cm. 24x51x44h 1 cesta cm. 21x45x15h - Tapa para cuba Producción patatas: 15 Kg/h cm. 40x90x90h</b>		⚡ 15 kW 12.900 kcal/h  ⚡ 0,005 kW 230V~ 50 Hz	<b>2.914,00</b> 69 / 0,46
<b>F25-94G</b> 09260451	FRIGGITRICE GAS LT. 25 Vasca cm. 31x51x44h - 2 cesti cm. 13,5x45x15h Coperchio vasca - Prod. patate: 25 kg/h • Gas fryer 25 lts - Pan cm. 31x51x44h 2 baskets cm. 13,5x45x15h - Lid for tank Production: 25 kg/h. • Gas-Friteuse lt. 25 - Becken cm. 31x51x44h 2 Körbe cm. 13,5x45x15h - Deckel für Becken Production: 25 kg/h • Friteuse à gaz lt. 25 - Cuve cm. 31x51x44h 2 Paniers cm. 13,5x45x15h - Couvercle pour cuve Pommes frites: 25 kg/h • <b>Freidoras a gas 25 lt. - Cuba cm. 31x51x44h 2 cestas cm. 13,5x45x15h - Tapa para cuba Producción patatas: 25 Kg/h cm. 40x90x90h</b>		⚡ 20 kW 17.200 kcal/h  ⚡ 0,005 kW 230V~ 50 Hz	<b>3.169,00</b> 75 / 0,46



## IPERLOTUS 90

MOD. COD.	DESCRIZIONE/DESCRIPTION/BEZEICHNUNG/DESCRIPTION/DESCRIPCIÓN DIMENSIONI/DIMENSIONS/ABMESSUNGEN/DIMENSIONS/DIMENSIONES	POTENZA/POWER/LEISTUNG/PUISSANCE/POTENCIA VOLTAGGIO/VOLTAGE/SPANNUNG/VOLTAGE/VOLTAJE	⚡ kW kcal/h	⚡ kw V~ Hz	PREZZO/PRICE € PREIS/PRIX/PRECIO € KG / M <sup>3</sup>
<b>F2/18-98ET</b> 09090830	FRIGGITRICE TRIFASE LT. 18+18 2 vasche cm. 31x34x33h - 2 cesti cm. 28x29x15h 2 coperchi vasche - Prod. patate: 30 kg/h <ul style="list-style-type: none"> <li>Fryer threephase 18+18 lts - 2 pans cm. 31x34x33h 2 baskets cm. 28x29x15h - 2 lids for tank Production: 30 kg/h</li> <li>Friteuse dreiphasig lt. 18+18 - 2 Becken cm. 31x34x33h 2 Körbe cm. 28x29x15h - 2 Deckel für Becken Pommes frites: 30 kg/h</li> <li>Friteuse triphase lt. 18+18 - 2 cuves cm. 31x34x33h 2 paniers cm. 28x29x15h - 2 couvercles pour cuve Production de pommes frites: 30 kg/h</li> </ul> <b>Freidoras trifásico 18+18 lt. - 2 cubas cm. 31x34x33h 2 cestas cm. 28x29x15h - 2 tapas para cuba Producción patatas: 30 Kg/h cm. 80x90x90h</b>		31,8 kW 400V~3N 50/60 Hz		<b>4.070,00</b> 106 / 0,88
<b>F2/25-98ET</b> 09090831	FRIGGITRICE TRIFASE LT. 25+25 2 vasche cm. 31x51x33h - 4 cesti cm. 13,5x45x15h 2 coperchi vasche - Prod. patate: 50 kg/h <ul style="list-style-type: none"> <li>Fryer threephase 25+25 lts. - 2 pans cm. 31x51x33h 4 baskets cm. 13,5x45x15h - 2 lids for tank Production: 50 kg/h</li> <li>Friteuse dreiphasig lt. 25+25 - 2 Becken cm. 31x51x33h 4 Körbe cm. 13,5x45x15h - 2 Deckel für Becken Pommes frites: 50 kg/h</li> <li>Friteuse triphase lt. 25+25 - 2 cuves cm. 31x51x33h 4 paniers cm. 13,5x45x15h - 2 couvercles pour cuve Production de pommes frites: 50 kg/h</li> </ul> <b>Freidoras trifásico 25+25 lt. - 2 cubas cm. 31x51x33h 4 cestas cm. 13,5x45x15h - 2 tapas para cuba Producción patatas: 50 Kg/h cm. 80x90x90h</b>		44 kW 400V~3N 50/60 Hz		<b>4.545,00</b> 114 / 0,88
<b>F2/18-98G</b> 09260850	FRIGGITRICE GAS LT. 18+18 2 vasche cm. 24x51x44h - 2 cesti cm. 21x45x15h 2 coperchi vasche - Prod. patate: 30 kg/h <ul style="list-style-type: none"> <li>Fryer gas 18+18 lts - 2 pans cm. 24x51x44h 2 baskets cm. 21x45x15h - 2 lids for tank Production: 30 kg/h</li> <li>Gas-Friteuse dreiphasig lt. 18+18 - 2 Becken cm. 24x51x44h 2 Körbe cm. 21x45x15h - 2 Deckel für Becken Pommes frites: 30 kg/h</li> <li>Friteuse à gaz lt. 18+18 - 2 cuves cm. 24x51x44h 2 paniers cm. 21x45x15h - 2 couvercles pour cuve Production de pommes frites: 30 kg/h</li> </ul> <b>Freidoras a gas 18+18 lt. - 2 cubas cm. 24x51x44h 2 cestas cm. 21x45x15h - 2 tapas para cuba Producción patatas: 30 Kg/h cm. 80x90x90h</b>		30 kW 25.770 kcal/h		<b>4.600,00</b> 116 / 0,88
<b>F2/25-98G</b> 09260851	FRIGGITRICE GAS LT. 25+25 2 vasche cm. 31x51x44h - 4 cesti cm. 13,5x45x15h 2 coperchi vasche - Prod. patate: 50 kg/h <ul style="list-style-type: none"> <li>Fryer gas 25+25 lts - 2 pans cm. 31x51x44h 4 baskets cm. 13,5x45x15h - 2 lids for tank Production: 50 kg/h</li> <li>Gas-Friteuse dreiphasig lt. 25+25 - 2 Becken cm. 31x51x44h 4 Körbe cm. 13,5x45x15h - 2 Deckel für Becken Pommes frites: 50 kg/h</li> <li>Friteuse à gaz lt. 25+25 - 2 cuves cm. 31x51x44h 4 paniers cm. 13,5x45x15h - 2 couvercles pour cuve Production de pommes frites: 50 kg/h</li> </ul> <b>Freidoras a gas 25+25 lt. - 2 cubas cm. 31x51x44h 4 cestas cm. 13,5x45x15h - 2 tapas para cuba Producción patatas: 50 Kg/h cm. 80x90x90h</b>		40 kW 34.360 kcal/h		<b>5.153,00</b> 126 / 0,88



# IPERLOTUS 90

MOD. / COD.	DESCRIZIONE / DESCRIPTION / BEZEICHNUNG / DESCRIPTION / DESCRIPCIÓN DIMENSIONI / DIMENSIONS / ABMESSUNGEN / DIMENSIONS / DIMENSIONES	POTENZA / POWER / LEISTUNG / PUISSANCE / POTENCIA VOLTAGGIO / VOLTAGE / SPANNUNG / VOLTAGE / VOLTAJE	$\frac{kW}{kcal/h}$ / $\frac{kW}{V}$ / Hz $\frac{kW}{kcal/h}$ / $\frac{kW}{V}$ / Hz	PREZZO / PRICE / PREIS / PRIX / PRECIO € / KG / M <sup>3</sup>
<b>BR80-98ET/F</b> 09070830	BRASIERA 80 LT. RIB. MANUALE Vasca fondo ferro con coperchio • 80 lts. manual tilt. brat pan - iron bottom with lid • Kippbratpfanne 80 lt. - Man. Kippung eisen boden mit Deckel • Sauteuse 80 lt. basc. manuel - Fond fer avec couvercle • <b>Sartén 80 lt. abat. manual - Fondo hierro con tapa cm. 80x90x90h</b>		$\frac{12 kW}{400V \sim 3N}$ 50/60 Hz	<b>5.339,00</b> 156 / 0,88
<b>BR80-98ET/I</b> 09070835	BRASIERA 80 LT. RIB. MANUALE Vasca fondo inoxcon coperchio • 80 lts. manual tilt. brat pan - Stainless steel bottom with lid • Kippbratpfanne 80 lt. - Man. Kippung inoxboden. mit Deckel • Sauteuse 80 lt. basc. manuel - Fond inoxavec couvercle • <b>Sartén 80 lt. abat. manual - Fondo de acero inox. con tapa cm. 80x90x90h</b>		$\frac{12 kW}{400V \sim 3N}$ 50/60 Hz	<b>5.803,00</b> 156 / 0,88
<b>BRM80-98ET/F</b> 09070831	BRASIERA 80 LT. RIB. AUTOMATICO Vasca fondo ferro con coperchio • 80 lts. automatic tilt. brat pan - iron bottom with lid • Bratpfanne 80 lt. - Autom. Kippung eisen boden mit Deckel • Sauteuse 80 lt. basc. automatique - Fond fer avec couvercle • <b>Sartén 80 lt. abat. automática - Fondo hierro con tapa cm. 80x90x90h</b>		$\frac{12,1 kW}{400V \sim 3N}$ 50 Hz	<b>6.613,00</b> 162 / 0,88
<b>BRM80-98ET/I</b> 09070836	BRASIERA 80 LT. RIB. AUTOMATICO Vasca fondo inoxcon coperchio • 80 lts. automatic tilt. brat pan - Stainless steel bottom with lid • Bratpfanne 80 lt. - Autom. Kippung inoxboden. mit Deckel • Sauteuse 80 lt. basc. automatique - Fond inoxavec couvercle • <b>Sartén 80 lt. abat. automática - Fondo de acero inox. con tapa cm. 80x90x90h</b>		$\frac{12,1 kW}{400V \sim 3N}$ 50 Hz	<b>7.090,00</b> 162 / 0,88
<b>BR80-98GF/F</b> 09240850	BRASIERA 80 LT. RIB. MANUALE Vasca fondo ferro con coperchio • 80 lts. manual tilt. brat pan - iron bottom with lid • Kippbratpfanne 80 lt. - Man. Kippung - eisen boden mit Deckel • Sauteuse 80 lt. basc. manuel - Fond fer avec couvercle • <b>Sartén 80 lt. abat. manual - Fondo hierro con tapa cm. 80x90x90h</b>		$\frac{22 kW}{18.920 kcal/h}$	<b>5.328,00</b> 159 / 0,88
<b>BR80-98GF/I</b> 09240855	BRASIERA 80 LT. RIB. MANUALE Vasca fondo inoxcon coperchio • 80 lts. manual tilt. brat pan - Stainless steel bottom with lid • Kippbratpfanne 80 lt. - Man. Kippung - inoxboden. mit Deckel • Sauteuse 80 lt. basc. manuel - Fond inoxavec couvercle • <b>Sartén 80 lt. abat. manual - Fondo de acero inox. con tapa cm. 80x90x90h</b>		$\frac{22 kW}{18.920 kcal/h}$	<b>5.708,00</b> 159 / 0,88
<b>BRM80-98GF/F</b> 09240851	BRASIERA 80 LT. RIB. AUTOMATICO Vasca fondo ferro con coperchio • 80 lts. automatic tilt. Brat pan - iron bottom with lid • Bratpfanne 80 lt. - Autom. Kippung - eisen boden mit Deckel • Sauteuse 80 lt. basc. automatique - Fond fer avec couvercle • <b>Sartén 80 lt. abat. automática - Fondo hierro con tapa cm. 80x90x90h</b>		$\frac{22 KW}{18.920 kcal/h}$ $\frac{0,1KW}{230V \sim}$ 50 Hz	<b>6.780,00</b> 165 / 0,88
<b>BRM80-98GF/I</b> 09240856	BRASIERA 80 LT. RIB. AUTOMATICO Vasca fondo inoxcon coperchio • 80 lts. automatic tilt. Brat pan - Stainless steel bottom with lid • Bratpfanne 80 lt. - Autom. Kippung - inoxboden. mit Deckel • Sauteuse 80 lt. basc. automatique - Fond inoxavec couvercle • <b>Sartén 80 lt. abat. automática - Fondo de acero inox. con tapa cm. 80x90x90h</b>		$\frac{22 KW}{18.920 kcal/h}$ $\frac{0,1KW}{230V \sim}$ 50 Hz	<b>7.160,00</b> 165 / 0,88



## IPERLOTUS 90

MOD. COD.	DESCRIZIONE / DESCRIPTION / BEZEICHNUNG / DESCRIPTION / DESCRIPCIÓN DIMENSIONI / DIMENSIONS / ABMESSUNGEN / DIMENSIONS / DIMENSIONES	POTENZA / POWER / LEISTUNG / PUISSANCE / POTENCIA VOLTAGGIO / VOLTAGE / SPANNUNG / VOLTAGE / VOLTAJE	⚡ kW kcal/h	⚡ kw V~ Hz	PREZZO / PRICE € PREIS / PRX / PRECIO KG / M <sup>3</sup>
<b>BRF-94ET</b> 09070433	BRASIERA FISSA MULTIFUNZIONALE ELETTRICA Vasca cm. 30x68x10h • Electric multi-function fixed braising pan Bowl cm. 30x68x10h • Elektrische Multifunktionsbratpfanne fest Becken cm. 30x68x10h • Sautéuse fixe multifonction électrique Cuve cm. 30x68x10h • <b>Sarten fija multifunción eléctrica Cuba</b> <b>cm. 30x68x10h</b> <b>cm. 40x90x90h</b>		5,2 kW 400V~2N 50/60 Hz		<b>3.306,00</b> 79 / 0,46
<b>BRF-98ET</b> 09070833	BRASIERA FISSA MULTIFUNZIONALE ELETTRICA Vasca cm. 70x68x10h • Electric multi-function fixed braising pan - Bowl cm. 70x68x10h • Elektrische Multifunktionsbratpfanne fest - Becken cm. 70x68x10h • Sautéuse fixe multifonction électrique - Cuve cm. 70x68x10h • <b>Sarten fija multifunción eléctrica -</b> <b>Cuba cm. 70x68x10h</b> <b>cm. 80x90x90h</b>		10,4 kW 400V~3N 230V~3 50/60 Hz		<b>4.778,00</b> 126 / 0,88
<b>BRF-94G</b> 09240453	BRASIERA FISSA MULTIFUNZIONALE GAS Vasca cm. 30x68x10h • Gas multi-function fixed braising pan - Bowl cm. 30x68x10h • Gas-Multifunktionsbratpfanne fest - Becken cm. 30x68x10h • Sautéuse fixe multifonction à gaz - Cuve cm. 30x68x10h • <b>Sarten fija multifunción a gas -</b> <b>Cuba cm. 30x68x10h</b> <b>cm. 40x90x90h</b>		9 kW 7.740 kcal/h		<b>3.849,00</b> 79 / 0,46
<b>BRF-98G</b> 09240853	BRASIERA FISSA MULTIFUNZIONALE GAS Vasca cm. 70x68x10h • Gas multi-function fixed braising pan - Bowl cm. 70x68x10h • Gas-Multifunktionsbratpfanne fest - Becken cm. 70x68x10h • Sautéuse fixe multifonction à gaz - Cuve cm. 70x68x10h • <b>Sarten fija multifunción a gas -</b> <b>Cuba cm. 70x68x10h</b> <b>cm. 80x90x90h</b>		18 kW 15.480 kcal/h		<b>5.494,00</b> 129 / 0,88
<b>BR120-912ETF/F</b> 09071230	BRASIERA 120 LT. RIB. MANUALE Vasca fondo ferro con coperchio • 120 lts. manual tilt. brat pan - iron bottom with lid • Kippbratpfanne 120 lt. - Man. Kippung eisen boden mit Deckel • Sautéuse 120 lt. basc. manuel - Fond fer avec couvercle • <b>Sartén 120 lt. abat. manual - Fondo hierro con tapa</b> <b>cm. 120x90x90h</b>		18 kW 400V~3N 50/60 Hz		<b>7.686,00</b> 205 / 1,31
<b>BR120-912ETF/I</b> 09071235	BRASIERA 120 LT. RIB. MANUALE Vasca fondo inox con coperchio • 120 lts. manual tilt. brat pan - Stainless steel bottom with lid • Kippbratpfanne 120 lt. - Man. Kippung inoxboden. mit Deckel • Sautéuse 120 lt. basc. manuel - Fond inoxavec couvercle • <b>Sartén 120 lt. abat. manual -</b> <b>Fondo de acero inox. con tapa</b> <b>cm. 120x90x90h</b>		18 kW 400V~3N 50/60 Hz		<b>8.450,00</b> 205 / 1,31
<b>BRM120-912ETF/F</b> 09071231	BRASIERA 120 LT. RIB. AUTOMATICO Vasca fondo ferro con coperchio • 120 lts. automatic tilt. brat pan - iron bottom with lid • Bratpfanne 120 lt. - Autom. Kippung eisen boden mit Deckel • Sautéuse 120 lt. basc. automatique - Fond fer avec couvercle • <b>Sartén 120 lt. abat. automática -</b> <b>Fondo hierro con tapa</b> <b>cm. 120x90x90h</b>		18,1 kW 400V~3N 50 Hz		<b>8.961,00</b> 211 / 1,31
<b>BRM120-912ETF/I</b> 09071236	BRASIERA 120 LT. RIB. AUTOMATICO Vasca fondo inox con coperchio • 120 lts. automatic tilt. brat pan - Stainless steel bottom with lid • Bratpfanne 120 lt. - Autom. Kippung inoxboden. mit Deckel • Sautéuse 120 lt. basc. automatique - Fond inoxavec couvercle • <b>Sartén 120 lt. abat. automática -</b> <b>Fondo de acero inox. con tapa</b> <b>cm. 120x90x90h</b>		18,1 kW 400V~3N 50 Hz		<b>9.725,00</b> 211 / 1,31

# IPERLOTUS 90

MOD. \_\_\_\_\_ DESCRIZIONE / DESCRIPTION / BEZEICHNUNG / DESCRIPTION / DESCRIPCIÓN POTENZA / POWER / LEISTUNG / PUISSANCE / POTENCIA PREZZO / PRICE €  
 COD. \_\_\_\_\_ DIMENSIONI / DIMENSIONS / ABMESSUNGEN / DIMENSIONS / DIMENSIONES VOLTAGGIO / VOLTAGE / SPANNUNG / VOLTAGE / VOLTAJE kcal/h kw kcal/h V~ Hz PREIS / PRIX / PRECIO € KG / MP

**BR120-912GF/F**  
09241250  
BRASIERA 120 LT. RIB. MANUALE  
Vasca fondo ferro con coperchio  
• 120 lts. manual tilt. brat pan - iron bottom with lid  
• Kippbratpfanne 120 lt. - Man. Kippung - eisen boden mit Deckel  
• Sauteuse 120 lt. basc. manuel - Fond fer avec couvercle  
• **Sartén 120 lt. abat. manual - Fondo hierro con tapa cm. 120x90x90h**



30 kW 25.800 kcal/h  
**7.572,00**  
208 / 1,31

**BR120-912GF/I**  
09241255  
BRASIERA 120 LT. RIB. MANUALE  
Vasca fondo inox con coperchio  
• 120 lts. manual tilt. brat pan - Stainless steel bottom with lid  
• Kippbratpfanne 120 lt. - Man. Kippung - inoxboden. mit Deckel  
• Sauteuse 120 lt. basc. manuel - Fond inoxavec couvercle  
• **Sartén 120 lt. abat. manual - Fondo de acero inox. con tapa cm. 120x90x90h**

30 kW 25.800 kcal/h  
**8.396,00**  
208 / 1,31

**BRM120-912GF/F**  
09241251  
BRASIERA 120 LT. RIB. AUTOMATICO  
Vasca fondo ferro con coperchio  
• 120 lts. automatic tilt. Brat pan - iron bottom with lid  
• Bratpfanne 120 lt. - Autom. Kippung - eisen boden mit Deckel  
• Sauteuse 120 lt. basc. automatique - Fond fer avec couvercle  
• **Sartén 120 lt. abat. automática - Fondo hierro con tapa cm. 120x90x90h**



30 KW 25.800 kcal/h  
**9.022,00**  
214 / 1,31  
0,1KW 230V~ 50 Hz

**BRM120-912GF/I**  
09241256  
BRASIERA 120 LT. RIB. AUTOMATICO  
Vasca fondo inox con coperchio  
• 120 lts. automatic tilt. Brat pan - Stainless steel bottom with lid  
• Bratpfanne 120 lt. - Autom. Kippung - inoxboden. mit Deckel  
• Sauteuse 120 lt. basc. automatique - Fond inoxavec couvercle  
• **Sartén 120 lt. abat. automática - Fondo de acero inox. con tapa cm. 120x90x90h**

30 KW 25.800 kcal/h  
**10.005,00**  
214 / 1,31  
0,1KW 230V~ 50 Hz

**PL-92**  
09010200  
PIANO LAVORO SU MOBILE  
• Worktop on cabinet  
• Arbeitsplatte mit Unterbau  
• Plan de travail sur armoire  
• **Sobre de trabajo sobre mueble cm. 20x90x90h**

**843,00**  
45 / 0,35

**PLS-94**  
09010401  
PIANO LAVORO SU MOBILE A GIORNO  
• Worktop on open cabinet  
• Arbeitsplatte mit offenem Unterbau  
• Plan de travail sur armoire ouvert  
• **Sobre de trabajo sobre mueble abierto cm. 40x90x90h**



**875,00**  
49 / 0,46

**PLS-96**  
09010601  
cm. 60x90x90h

**1.299,00**  
59 / 0,72



**PLS-98**  
09010801  
cm. 80x90x90h



**1.380,00**  
70 / 0,88

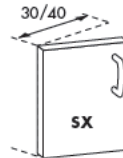
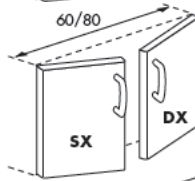
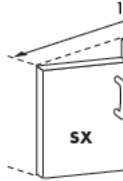

# IPERLOTUS 90

MOD. COD.	DESCRIZIONE/DESCRIPTION/BEZEICHNUNG/DESCRIPTION/DESCRIPCIÓN DIMENSIONI/DIMENSIONS/ABMESSUNGEN/DIMENSIONS/DIMENSIONES	POTENZA/POWER/LEISTUNG/PUISSANCE/POTENCIA VOLTAGGIO/VOLTAGE/SPANNUNG/VOLTAGE/VOLTAJE	kW kcal/h	PREZZO/PRICE € PREIS/PRIX/PRECIO € KG / M <sup>3</sup>
<b>PL-94</b> 09010400	<b>PIANO LAVORO SU MOBILE A GIORNO</b> Cassetto con 1 bacinella GN 1/1 15h in plastica • Worktop on open cabinet Drawer with 1 plastic container GN 1/1 15h • Arbeitsplatte mit offenem Unterbau Schublade mit 1 GN 1/1 15h Kunststoffbehälter • Plan de travail sur armoire ouvert Tiroir avec bac en plastique GN 1/1 15h • <b>Sobre de trabajo sobre mueble abierto Cajón con 1 contenedor GN 1/1 15h plástico</b> <b>cm. 40x90x90h</b>			<b>1.070,00</b> 54 / 0,46
<b>PL-96</b> 09010600	<b>PIANO LAVORO SU MOBILE A GIORNO</b> Cassetto cm. 49,5x50x15h inox • Worktop on open cabinet Drawer cm. 49,5x50x15h • Arbeitsplatte mit offenem Unterbau. Schublade cm. 49,5x50x15h • Plan de travail sur armoire ouvert. Tiroir inox cm. 49,5x50x15h • <b>Sobre de trabajo con mueble abierto. Cajón cm. 49,5x50x15h inox</b> <b>cm. 60x90x90h</b>			<b>1.515,00</b> 70 / 0,72
<b>PL-98</b> 09010800	<b>PIANO LAVORO SU MOBILE A GIORNO</b> Cassetto con 2 bacinelle GN 1/1 15h in plastica • Worktop on open cabinet Drawer with 2 plastic containers GN 1/1 15h • Arbeitsplatte mit offenem Unterbau Schublade mit 2 GN 1/1 15h Kunststoffbehälter • Plan de travail sur armoire ouvert Tiroir avec 2 bacs en plastique GN 1/1 15h • <b>Sobre de trabajo sobre mueble abierto Cajón con 2 contenedores GN 1/1 15h plástico</b> <b>cm. 80x90x90h</b>			<b>1.618,00</b> 82 / 0,88
<b>LA-94</b> 09020400	<b>LAVELLO SU MOBILE A GIORNO</b> Rubinetto a leva - Vasca cm. 30x35x15h • Sink unit on open cabinet - Lever type tap. Bowl cm. 30x35x15h • Spülbecken Einhebel-Mischbatterie mit offenem Unterbau - Becken cm. 30x35x15h • Bac-évier sur armoire ouvert avec robinetterie - Bac cm. 30x35x15h • <b>Fregadero sobre mueble abierto - Grifo a palanca - Pileta cm. 30x35x15h</b> <b>cm. 40x90x90h</b>			<b>1.290,00</b> 53 / 0,46
<b>P-73/93-DX</b> 08430300	<b>PORTA 300 DESTRA</b> • Right door 300 • Rechte tür 300 • Porte droite 300 • <b>Puerta derecha 300</b> <b>cm. 29,5x2,5x47,5h</b>			<b>159,00</b> 3 / 0,005
<b>P-74/94-DX</b> 08430400	<b>PORTA 400 DESTRA</b> • Right door 400 • Rechte tür 400 • Porte droite 400 • <b>Puerta derecha 400</b> <b>cm. 39,5x2,5x47,5h</b>			<b>165,00</b> 3,5 / 0,006
<b>P-73/93-SX</b> 08430301	<b>PORTA 300 SINISTRA</b> • Left door 300 • Linke tür 300 • Porte gauche 300 • <b>Puerta iziquierda 300</b> <b>cm. 29,5x2,5x47,5h</b>			<b>159,00</b> 3 / 0,005
<b>P-74/94-SX</b> 08430401	<b>PORTA 400 SINISTRA</b> • Left door 400 • Linke tür 400 • Porte gauche 400 • <b>Puerta iziquierda 400</b> <b>cm. 39,5x2,5x47,5h</b>			<b>165,00</b> 3,5 / 0,006

# IPERLOTUS 90

<b>MOD.</b> _____ <b>COD.</b> _____	<b>DESCRIZIONE / DESCRIPTION / BEZEICHNUNG / DESCRIPTION / DESCRIPCIÓN</b> <b>DIMENSIONI / DIMENSIONS / ABMESSUNGEN / DIMENSIONS / DIMENSIONES</b>	<b>POTENZA / POWER / LEISTUNG / PUISSANCE / POTENCIA</b> <b>VOLTAGGIO / VOLTAGE / SPANNUNG / VOLTAGE / VOLTAJE</b>	$\frac{\text{kWh}}{\text{kcal/h}}$ $\frac{\text{V}}{\text{Hz}}$	<b>PREZZO / PRICE</b> € <b>PREIS / PRIX / PRECIO</b> € KG / M <sup>3</sup>
--	---	---	--	--

**C-74/94**  
08440420

CASSETTIERA 400 - N. 2 cassetti con 2 bacinelle GN 1/1 15h in plastica, guide telescopiche. Solo su PL

- Drawer set 400 - N. 2 drawers with 2 GN 1/1 15h plastic containers, telescopic guides. Only for PL
- Schubladen - N. 2 Schubladen mit 2 GN 1/1 15h Kunststoffbehältern, Telescopeinführungen. Nur für PL
- Tiroirs pour meuble de 400 - N. 2 tiroirs avec 2 bacs en plastique GN 1/1 15h, guides télescopiques. Seulement pour PL

• **Cajonera 400 - N. 2 cajones con 2 contenedores GN 1/1 15h de plástico, guías telescópicas. Solo para PL**  
**cm. 39,5x59x47,5h**

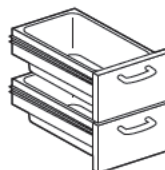

**635,00**  
18 / 0,11

**C-76/96**  
08440620

CASSETTIERA 600 N. 2 cassetti con 2 bacinelle inox, guide telescopiche. Solo su PL

- Drawer set 600 N. 2 drawers with 2 inoxcontainers, telescopic guides. Only for PL
- Schubladen 600 - N. 2 Schubladen mit 2 Chromnickelstahlbehältern, Telescopeinführungen. Nur für PL
- Tiroirs pour meuble de 600 N. 2 tiroirs avec 2 bacs inox, guides télescopiques. Seulement pour PL

• **Cajonera 600 - N. 2 cajones con 2 contenedores de acero inox, guías telescópicas. Solo para PL**  
**cm. 59,5x59x47,5h**

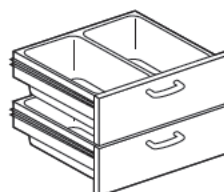

**879,00**  
22 / 0,18

**C-78/98**  
08440820

CASSETTIERA 800 - N. 2 cassetti con 4 bacinelle GN 1/1 15h in plastica, guide telescopiche. Solo su PL

- Drawer set 800 - N. 2 drawers with 4 GN 1/1 15h plastic containers, telescopic guides. Only for PL
- Schubladen 800 - N. 2 Schubladen mit 4 GN 1/1 15h Kunststoffbehältern, Telescopeinführungen. Nur für PL
- Tiroirs pour meuble de 800 - N. 2 tiroirs avec 4 bacs en plastique GN 1/1 15h, guides télescopiques. Seulement pour PL

• **Cajonera 800 - N. 2 cajones con 4 contenedores GN 1/1 15h de plástico, guías telescópicas. Solo para PL**  
**cm. 79,5x59x47,5h**

**896,00**  
26 / 0,22

**D-9**  
09470000

DIVISORIO



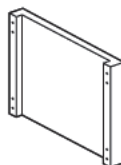

- Spacer
- Trennwand
- Separation
- **Divisorio**

**cm. 5x79x45h**







**176,00**  
2,5 / 0,015

## IPERLOTUS 90

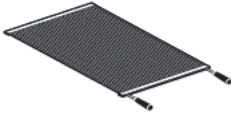
MOD. COD.	DESCRIZIONE/DESCRIPTION/BEZEICHNUNG/DESCRIPTION/DESCRIPCIÓN DIMENSIONI/DIMENSIONS/ABMESSUNGEN/DIMENSIONS/DIMENSIONES	POTENZA/POWER/LEISTUNG/PUISSANCE/POTENCIA VOLTAGGIO/VOLTAGE/SPANIUNG/VOLTAGE/VOLTAGE kW kcal/h	1 kw V Hz	PREZZO/PRICE € PREIS/PRIX/PRECIO € KG / M <sup>3</sup>
531070300	<p>CESTO PER SOLLEVATORE CESTI 1/1S PER CP-94/98 &amp; CPB-98</p> <ul style="list-style-type: none"> <li>• Basket for basket elevator 1/1S for CP-94/98 &amp; CPB-98</li> <li>• Korb für heben Korbe 1/1S für CP-94/98 &amp; CPB-98</li> <li>• Panier pour soulever des paniers 1/1S pour CP-94/98 &amp; CPB-98</li> <li>• <b>Cesta para levante cestas 1/1S para CP-94/98 &amp; CPB-98</b></li> </ul> <p>cm. 28x49x21,5h</p>			<p><b>201,00</b> 3,5 / 0,06</p>
531070200	<p>CESTO PER SOLLEVATORE CESTI 1/1S PER CP-74/78 - 2/3S PER CP-94/98 &amp; CPB-98</p> <ul style="list-style-type: none"> <li>• Basket for basket elevator 1/1S for CP-74/78 - 2/3S for CP-94/98 &amp; CPB-98</li> <li>• Korb für heben Korbe 1/1S für CP-74/78 - 2/3S für CP-94/98 &amp; CPB-98</li> <li>• Panier pour soulever des paniers 1/1S pour CP-74/78 - 2/3S pour CP-94/98 &amp; CPB-98</li> <li>• <b>Cesta para levante cestas 1/1S para CP-74/78 - 2/3S para CP-94/98 &amp; CPB-98</b></li> </ul> <p>cm. 28x32x21,5h</p>			<p><b>138,00</b> 2 / 0,04</p>
531070100	<p>CESTO PER SOLLEVATORE CESTI 1/2S PER CP-94/98 &amp; CPB-98</p> <ul style="list-style-type: none"> <li>• Basket for basket elevator 1/2S for CP-94/98 &amp; CPB-98</li> <li>• Korb für heben Korbe 1/2S für CP-94/98 &amp; CPB-98 mit heben Korbe</li> <li>• Panier avec soulever des paniers 1/2S pour CP-94/98 &amp; CPB-98</li> <li>• <b>Cesta para levante cestas 1/2S para CP-94/98 &amp; CPB-98</b></li> </ul> <p>cm. 28x24x21,5h</p>			<p><b>125,00</b> 1 / 0,031</p>
531047900	<p>CESTO PER SOLLEVATORE CESTI 1/2S PER CP-74/78 - 1/3S PER CP-94/98 &amp; CPB-98</p> <ul style="list-style-type: none"> <li>• Basket for basket elevator 1/2S for CP-74/78 - 1/3S for CP-94/98 &amp; CPB-98</li> <li>• Korb für heben Korbe 1/2S für CP-74/78 - 1/3S für CP-94/98 &amp; CPB-98</li> <li>• Panier avec soulever des paniers 1/2S pour CP-74/78 - 1/3S pour CP-94/98 &amp; CPB-98</li> <li>• <b>Cesta para levante cestas 1/2S para CP-74/78 - 1/3S para CP-94/98 &amp; CPB-98</b></li> </ul> <p>cm. 28x16x21,5h</p>			<p><b>99,00</b> 1,5 / 0,02</p>
531048000	<p>CESTO PER SOLLEVATORE CESTI 1/4S PER CP-74/78 - 1/6S PER CP-94/98 &amp; CPB-98</p> <ul style="list-style-type: none"> <li>• Basket for basket elevator 1/4S for CP-74/78 - 1/6S for CP-94/98 &amp; CPB-98</li> <li>• Korb für heben Korbe 1/4S für CP-74/78 - 1/6S für CP-94/98 &amp; CPB-98</li> <li>• Panier avec soulever des paniers 1/4S pour CP-74/78 - 1/6S pour CP-94/98 &amp; CPB-98</li> <li>• <b>Cesta para levante cestas 1/4S para CP-74/78 - 1/6S para CP-94/98 &amp; CPB-98</b></li> </ul> <p>cm. 13,5x16x21,5h</p>			<p><b>76,00</b> 1 / 0,013</p>



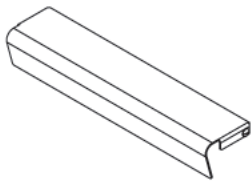

# IPERLOTUS 90

MOD. / COD.	DESCRIZIONE / DESCRIPTION / BEZEICHNUNG / DESCRIPTION / DESCRIPCIÓN DIMENSIONI / DIMENSIONS / ABMESSUNGEN / DIMENSIONS / DIMENSIONES	POTENZA / POWER / LEISTUNG / PUISSANCE / POTENCIA VOLTAGGIO / VOLTAGE / SPANNUNG / VOLTAGE / VOLTAJE	$\frac{kW}{kcal/h}$ / $\frac{kW}{V \cdot Hz}$	PREZZO / PRICE € PREIS / PRIK / PRECIO € KG / M <sup>3</sup>
CEA 09580010	COLONNINA EROGAZIONE ACQUA <ul style="list-style-type: none"> <li>• Pillar tap</li> <li>• Mischbatterie</li> <li>• Colonne de distribution eau</li> <li>• <b>Rubinetto dispensador de agua</b></li> </ul>			<b>344,00</b> 6 / 0,02
CEAT 19580010	COLONNINA EROGAZIONE ACQUA TOP <ul style="list-style-type: none"> <li>• Pillar tap top</li> <li>• Mischbatterie top</li> <li>• Colonne de distribution eau top</li> <li>• <b>Rubinetto dispensador de agua top</b></li> </ul>			<b>344,00</b> 5 / 0,02
531047100	GRIGLIA IN TONDINO 2 FUOCHI (serie 90) <ul style="list-style-type: none"> <li>• Grid rod 2 burner (90 line)</li> <li>• Gitterstab 2 Brenner (90. Serie)</li> <li>• Tige grille 2 feux (serie 90)</li> <li>• <b>Red de varilla 2 quemador (serie 90)</b></li> </ul>			<b>172,00</b> 9 / 0,03
09570401	GRIGLIA TONDINO per CW (SERIE 90) <ul style="list-style-type: none"> <li>• Grid for CW (90 line)</li> <li>• Gitter für CW (90. Serie)</li> <li>• Grille ronde pour CW (serie 90)</li> <li>• <b>Rejilla para CW (serie 90)</b></li> <li>• <b>cm. 36x68</b></li> </ul>			<b>453,00</b> 12 / 0,015
09570402	GRIGLIA TEGOLO V per CW (SERIE 90) <ul style="list-style-type: none"> <li>• Grid V for CW (90 line)</li> <li>• Gitter V für CW (90. Serie)</li> <li>• Grille V pour CW (serie 90)</li> <li>• <b>Rejilla V para CW (serie 90)</b></li> <li>• <b>cm. 36x68</b></li> </ul>			<b>453,00</b> 12 / 0,015
544023800	RASCHIETTO PER PIASTRA RIGATA <ul style="list-style-type: none"> <li>• Scraper for gooved plate</li> <li>• Schaber für gerillte Kochplatte</li> <li>• Racloir pour plaque nervurée</li> <li>• <b>Rasqueta para placa ranurada</b></li> </ul>			<b>50,00</b>
531040800	RASCHIETTO PER PIASTRA LISCIA CROMATA <ul style="list-style-type: none"> <li>• Scraper for smooth chromed plate</li> <li>• Schaber für glatte verchromte Platte</li> <li>• Racloir pour plaque lisse au chrome</li> <li>• <b>Rasqueta para placa lisa cromada</b></li> </ul>			<b>47,00</b>
531040900	KIT 10 LAME PER RASCHIETTO <ul style="list-style-type: none"> <li>• 10 blades kit for scraper</li> <li>• Kit 10 Klängen für Schaber</li> <li>• Kit de 10 lames pour racloir</li> <li>• <b>Kit de 10 cuchillas para rasqueta</b></li> </ul>			<b>33,00</b>
T-FT 09580060	TAPPO PER FRY-TOP <ul style="list-style-type: none"> <li>• Stopper for Fry-top</li> <li>• Stopfen griddleplatte</li> <li>• Bouchon pour Plaque</li> <li>• <b>Tapón Fry-top</b></li> <li>• <b>cm. 10x2x5h</b></li> </ul>			<b>201,00</b>
PFT-94 09620400	KIT PROTEZIONE FRONTALE PIANO FRY-TOP <ul style="list-style-type: none"> <li>• KIT front protection plan fry-top</li> <li>• Schutz-kit vorne Plan griddleplatte</li> <li>• KIT protection avant plan plaque</li> <li>• <b>KIT de protección frontal plan de fry-top</b></li> <li>• <b>cm. 35x11x6h</b></li> </ul>			<b>134,00</b>
PFT-98 09620400	<b>cm. 75x11x6h</b>			<b>226,00</b>

## IPERLOTUS 90

MOD. COD.	DESCRIZIONE/DESCRIPTION/BEZEICHNUNG/DESCRIPTION/DESCRIPCIÓN DIMENSIONI/DIMENSIONS/ABMESSUNGEN/DIMENSIONS/DIMENSIONES	POTENZA/POWER/LEISTUNG/PUISSANCE/POTENCIA VOLTAGGIO/VOLTAGE/SPANNUNG/VOLTAGE/VOLTAJE	kW kcal/h	PREZZO/PRICE € PREIS/PRIX/PRECIO € KG / M <sup>3</sup>
531041600	CESTINO 1/2 per F18-E & F16P-G • Basket 1/2 for F18-E & F16P-G / • Korb 1/2 zur Friteuse F18-E & F16P-G • Panier 1/2 pour F18-E & F16P-G / • <b>Cesta 1/2 para F18-E &amp; F16P-G</b> <b>cm. 13,5x29x15h</b>			<b>62,00</b> 0,8 / 0,015
531041500	CESTINO 1/2 per F18-90G • Basket 1/2 for F18-90G / • Korb 1/2 für Friteuse F18-90G • Panier 1/2 pour F18-90G / • <b>Cesta 1/2 para F18-90G</b> <b>cm. 10x45x15h</b>			<b>62,00</b> 0,8 / 0,015
531041400	CESTINO 1/1 per F25-G/E • Basket 1/1 for F25-G/E / • Korb 1/1 für Friteuse F25-G/E • Panier 1/1 pour F25-G/E / • <b>Cesta 1/1 para F25-G/E</b> <b>cm. 28x45x15h</b>			<b>109,00</b> 1,5 / 0,035
531069600	CESTINO 1/1 per F23P-G • Basket 1/1 for F23P-G / • Korb 1/1 für Friteuse F23P-G • Panier 1/1 pour F23P-G / • <b>Cesta 1/1 para F23P-G</b> <b>cm. 28x39x15h</b>			<b>109,00</b> 1,5 / 0,035
KITSS-90 09580050	KIT SCIOGLIMENTO STRUTTO, solo per friggitori elettriche a mobile. • Kit for lard melting, only for electric fryers on cabinet • Satz fuer schmalzschmelzen, nur für elektrische Friteusen mit unterbau • Kit de dissolution lard, seulement pour les friteuses électriques sur armoire • <b>Kit de disolución de manteca, sólo para freidoras eléctricas on mueble</b>		0,31 kW	<b>101,00</b>
BF30 09580030	BACINELLA RACCOGLI OLIO CON FILTRO LT. 30 PER FRIGGITRICE • 30 lts. oil collecting tray - With filter for deep fryer • Ölauffangwanne mit Filter, 30 Liter, für Friteuse • Bac de récupération de l'huile Avec filtre 30 lt. pour friteuse • <b>Bandeja para aceite con filtro - 30 lt. para freidora</b> <b>cm. 29x29x37h</b>			<b>180,00</b> 7 / 0,05
09550400	COPERCHIO per BRF-94 • Lid for BFR-94 / • Deckel für BFR-94 • Couvercle pour BFR-94 / • <b>Tapa para BFR-94</b> <b>cm. 32x70x5h</b>			<b>114,00</b> 2,5 / 0,02
09550800	COPERCHIO per BRF-98 • Lid for BFR-98 / • Deckel für BFR-98 • Couvercle pour BFR-98 / • <b>Tapa para BFR-98</b> <b>cm. 72x70x5h</b>			<b>152,00</b> 5 / 0,04
TG-94 09580400	TAGLIERE PLASTICA • Plastic chopping-board / • Schneidebrett • Plan de decoupe / • <b>Picador de plástico</b> <b>cm. 39x75x2,5h</b>			<b>122,00</b> 8 / 0,015
TG-98 09580800	TAGLIERE PLASTICA • Plastic chopping-board / • Schneidebrett • Plan de decoupe / • <b>Picador de plástico</b> <b>cm. 79x75x2,5h</b>			<b>246,00</b> 14 / 0,025
PLF/9 09590401	PIASTRA LISCIA per GRIGLIA IN GHISA • Smooth griddle plate for cast iron grid / • Fortkochplatte glatt für Gusseisen Rost • Plaque lisse pour la grille en fonte / • <b>Plancha lisa para rejilla de hierro fundido</b> <b>cm. 36x39</b>			<b>161,00</b> 11 / 0,006
PRF/9 09590403	PIASTRA RIGATA per GRIGLIA IN GHISA / •Grooved griddle plate for cast iron grid • Fortkochplatte gerillt für Gusseisen Rost / •Plaque nervurée pour la grille en fonte • <b>Plancha estriada para rejilla de hierro fundido</b> <b>cm. 36x39</b>			<b>216,00</b> 11 / 0,006
PLFT/9 09590451	PIASTRA LISCIA per GRIGLIA IN TONDINO • Smooth griddle plate for grid rod / • Fortkochplatte glatt für Gitterstab • Plaque lisse pour tige grille / • <b>Plancha lisa por red de varilla</b> <b>cm. 36x39</b>			<b>155,00</b> 11 / 0,006
PRFT/9 09590453	PIASTRA RIGATA per GRIGLIA IN TONDINO • Grooved griddle plate for grid rod / • Fortkochplatte gerillt für Gitterstab • Plaque nervurée pour tige grille / • <b>Plancha estriada por red de varilla</b> <b>cm. 36x39</b>			<b>210,00</b> 11 / 0,006

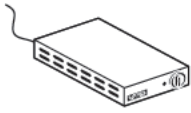
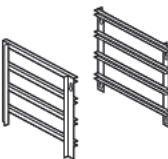
# IPERLOTUS 90

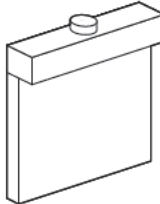
MOD. / COD.	DESCRIZIONE / DESCRIPTION / BEZEICHNUNG / DESCRIPTION / DESCRIPCIÓN DIMENSIONI / DIMENSIONS / ABMESSUNGEN / DIMENSIONS / DIMENSIONES	POTENZA / POWER / LEISTUNG / PUISSANCE / POTENCIA VOLTAGGIO / VOLTAGE / SPANNUNG / VOLTAGE / VOLTAJE	$\frac{kW}{kcal/h}$ / $\frac{kw}{V}$ / $\frac{Hz}{}$	PREZZO / PRICE / PREIS / PRIX / PRECIO € / KG / M <sup>3</sup>
<b>533009200</b>	<b>GRIGLIA DI RIDUZIONE</b> • Reduction / • Reduzierstern • Grille de réduction / • <b>Rejilla de reducción</b> <b>cm. 25x25</b>			<b>30,00</b> 0,2 / 0,001
<b>KIT-WOK</b> 09580040	<b>KIT WOK - fiamma verticale - solo su bruciatore da 10 kW e griglie in ghisa</b> • KIT WOK - vertical flame - only for 10 kW burner and cast iron grills • KIT WOK - vertikaler Flamme - nur 10 kW-Brenner und Roste aus Gusseisen • KIT WOK - verticale de la flamme - seulement 10 kW brûleur et grilles en fonte • <b>KIT WOK - llama vertical - sólo 10 kW quemador y parrilas de hierro colado</b> <b>cm. Ø 26x16h</b>			<b>341,00</b> 5 / 0,01
<b>544439900</b>	<b>ANELLO PER WOK - solo per griglie in ghisa</b> • Wok ring - only for cast iron grills • Wok Aufsatzring - nur für Roste aus Gusseisen • Anneau Wok - seulement pour grilles en fonte • <b>Anillo Wok - solo para parrilas de hierro colado</b> <b>cm. Ø22,5x3,5h</b>			<b>127,00</b> 2 / 0,006
<b>RV</b> 08660410	<b>RISCALDANTE VANO CUCINA</b> • Heater for range's cabinet • Heizer für Herden-Schränkelement • Réchauffeur pour armoire du fourneau • <b>Calefacción para armario neutro de la cocina</b> <b>cm. 32x48,5x8h</b>		$\frac{0,75 kW}{230V \sim}$ 50/60 Hz	<b>731,00</b> 8 / 0,03
<b>PT-74/94</b> 08460002	<b>PORTATEGLIE VANO 400 (GN-1/1) V</b> <b>ANO 600 (GN-2/1) 4 ripiani int. 7 cm.</b> • Frame for plates 400 (GN-1/1) 600 (GN-2/1) - N. 4 shelves, wheel-base 7 cm. • Aufangeschienen für bleche 400 (GN-1/1) 600 (GN-2/1) - N. 4 Etagen, Abstand 7 cm. • Kit porte-plaques 400 (GN-1/1) 600 (GN-2/1) - N. 4 étagères; 7 cm. • <b>Portacazuelas 400 (GN-1/1) 600 (GN-2/1) - N. 4 estantes, int. 7 cm.</b>		<b>SOLO PL E VANO CUCINE</b> • Only on cooking area, PL • Nur im der neutralen schrankelement, PL • Seulement sur element neutre du four, PL • Solo en zona cocina, PL	<b>344,00</b> 2,5 / 0,01
<b>PT-78/98</b> 08460012	<b>PORTATEGLIE VANO 800 (GN-2/1) 4 ripiani int. 7 cm.</b> • Frame for plates 800 (GN-2/1) 4 Etagen, Abstand 7 cm. • Aufangeschienen für bleche 800 (GN-2/1) N. 4 Etagen, Abstand 7 cm. • Kit porte-plaques 800 (GN-2/1) - N. 4 étagères; 7 cm. • <b>Portacazuelas 800 (GN-2/1) - N. 4 estantes, int. 7 cm.</b>			<b>459,00</b> 4 / 0,02
<b>09610400</b>	<b>MITRA 400</b> • Chimney jack 400 / • Lüftungsaufsatz 400 • Mitre 400 / • <b>Caperuza 400</b> <b>cm. 40x7x95</b>			<b>324,00</b> 8 / 0,2
<b>09610800</b>	<b>MITRA 800</b> • Chimney jack 800 / • Lüftungsaufsatz 800 • Mitre 800 / • <b>Caperuza 800</b> <b>cm. 80x19x94</b>			<b>538,00</b> 8 / 0,2
<b>09610401</b>	<b>CAMINO ANTIVENTO 400</b> • Draught diverter 400 • Strömungssicherung 400 • Cheminee anti-vent 400 • <b>Chimenea contra viento 400</b> <b>cm. 40x18x120</b>			<b>569,00</b> 8 / 0,08
<b>09610801</b>	<b>cm. 80x18x120</b>			<b>666,00</b> 17,5 / 0,15
<b>09611201</b>	<b>cm. 120x18x120</b>			<b>879,00</b> 23,5 / 0,25

# IPERLOTUS 90

MOD. COD.	DESCRIZIONE / DESCRIPTION / BEZEICHNUNG / DESCRIPTION / DESCRIPCIÓN DIMENSIONI / DIMENSIONS / ABMESSUNGEN / DIMENSIONS / DIMENSIONES	POTENZA / POWER / LEISTUNG / PUISSANCE / POTENCIA VOLTAGGIO / VOLTAGE / SPANNUNG / VOLTAGE / VOLTAJE	$\frac{kW}{kcal/h}$ $\frac{hp}{V}$ Hz	PREZZO / PRICE PREIS / PRIX / PRECIO € KG / M <sup>3</sup>
--------------	---	---	--	--

**TPC-9**  
09560002

TESTATA CHIUSURA PER CF-PC-TP (SOLO GAS)

- Head end filler strip for CF-PC-TP (Gas only)
- Abschluss-Element für CF-PC-TP (nur gas)
- Élément de jonction pour CF-PC-TP (seulement gaz)
- **Chapa de cierre para CF-PC-TP (solo gas)**



**58,00**  
1 / 0,001

**TPA-9**  
09560001

TESTATA CHIUSURA PER TUTTI GLI ALTRI MODELLI

- Head end filler strip for all other models
- Abschluss-Element für alle anderen Modelle
- Élément de jonction pour tous les autres modèles
- **Chapa de cierre para todos los demás modelos**

**58,00**  
1 / 0,001

TESTATA 1 LATO SERIE 90

- Head 1 side S90
- Abschluss element 1 seite S90
- Element de jonction 1 coté S90
- **Embellecedor 1 lado S90**



**221,00**  
10 / 0,01

TESTATA 2 LATI SERIE 90

- Head 2 sides S90
- Abschluss element seiten S90
- Element de jonction 2 cotés S90
- **Embellecedor 2 lados S90**



**441,00**  
20 / 0,02

**SIA-7/9**  
08480000

STAFFA INFERIORE UNIONE APPARECCHI

- Lower bracket to join two items

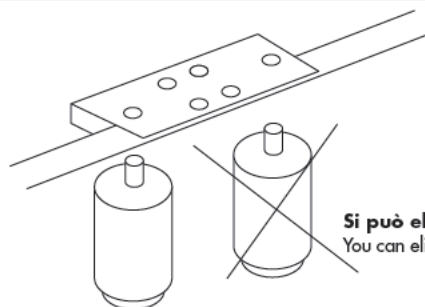

Si può eliminare  
You can eliminate

**48,00**  
2 / 0,001

**SR-100**  
50900001

SET 4 RUOTE Ø 100x30, 2 con freno

- Set of 4 wheels Ø 100x30, 2 with brake
- 4 Rollen Satz Ø 100x30, 2 davon mit Feststellbremse
- Kit 4 roues Ø 100x30, 2 avec frein
- **Equipo 4 ruedas Ø 100x30, 2 con frenos cm. 12,7h**



**288,00**  
1 / 0,01

# IPERLOTUS 90

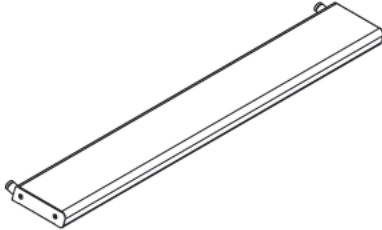

MOD. / COD.	DESCRIZIONE / DESCRIPTION / BEZEICHNUNG / DESCRIPTION / DESCRIPCIÓN DIMENSIONI / DIMENSIONS / ABMESSUNGEN / DIMENSIONS / DIMENSIONES	POTENZA / POWER / LEISTUNG / PUISSANCE / POTENCIA VOLTAGGIO / VOLTAGE / SPANNUNG / VOLTAGE / VOLTAJE	kW kcal/h	kw V~ Hz	PREZZO / PRICE € PREIS / PRX / PRECIO € KG / M <sup>3</sup>
-------------	---	---	--------------	----------------	---

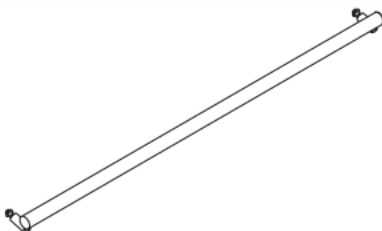
	Mensola anteriore • Earlier shelf • Frühere Regal • Plus tôt plateau • <b>A principios de la plataforma</b>				
08570103	cm. 30x21x5h				329,00
08570104	cm. 40x21x5h		337,00		
08570105	cm. 50x21x5h		348,00		
08570106	cm. 60x21x5h		357,00		
08570107	cm. 70x21x5h		365,00		
08570108	cm. 80x21x5h		374,00		
08570109	cm. 90x21x5h		385,00		
08570110	cm. 100x21x5h		394,00		
08570111	cm. 110x21x5h		405,00		
08570112	cm. 120x21x5h		416,00		
08570113	cm. 130x21x5h		429,00		
08570114	cm. 140x21x5h		439,00		
08570115	cm. 150x21x5h		453,00		
08570116	cm. 160x21x5h		466,00		

	Corrimano • Handrail • Hand Lauf • Main courante • <b>Pasamano</b>				
08570002	cm. 20x7x4h				274,00
08570003	cm. 30x7x4h		279,00		
08570004	cm. 40x7x4h		282,00		
08570005	cm. 50x7x4h		291,00		
08570006	cm. 60x7x4h		299,00		
08570007	cm. 70x7x4h		305,00		
08570008	cm. 80x7x4h		310,00		
08570009	cm. 90x7x4h		314,00		
08570010	cm. 100x7x4h		319,00		
08570011	cm. 110x7x4h		329,00		
08570012	cm. 120x7x4h		337,00		
08570013	cm. 130x7x4h		349,00		
08570014	cm. 140x7x4h		360,00		
08570015	cm. 150x7x4h		393,00		
08570016	cm. 160x7x4h		425,00		

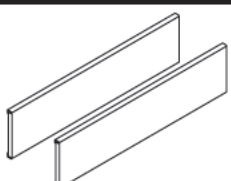
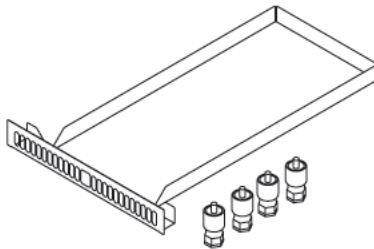

# IPERLOTUS 90

MOD. COD.	DESCRIZIONE/DESCRIPTION/BEZEICHNUNG/DESCRIPTION/DESCRIPCIÓN DIMENSIONI/DIMENSIONS/ABMESSUNGEN/DIMENSIONS/DIMENSIONES	POTENZA/POWER/LEISTUNG/PUISSANCE/POTENCIA VOLTAGGIO/VOLTAGE/SPANUNG/VOLTAGE/VOLTAGE	$\frac{kW}{kcal/h}$ $\frac{kw}{V-}$ Hz	PREZZO/PRICE € PREIS/PRIX/PRECIO € KG / M <sup>3</sup>
<b>533116300</b>	Giunzione corrimano • Jjunction handrail • Gelenk Hand lauf • Main courante de l'embranchement • <b>Conexión pasamano</b> <b>cm. Ø 3x2,4</b>			<b>43,00</b>
<b>ZB</b> 01410000	ZOCCOLATURA BASE • Front plinth • Grundsokkel • Plinthe frontal • <b>Zocolos base</b> <b>a mt.</b>			<b>114,00</b>
<b>FZ-9</b> 09480001	ZOCCOLATURA LATERALE - KIT • Side plinth - kit • Seitensokkel - kit • Plinthe lateral - kit • <b>Zocolos lateral - kit</b> <b>cm. 1,5x80x6h</b>			<b>243,00</b>
<b>CZ-94</b> 09480004	CASSETTO ZOCCOLO - KIT • Drawer clog - kit • Schubladen sockel - kit • Tiroir plinthe - kit • <b>Cajon zocolos - kit</b> <b>cm. 40x81x5,5h</b>			<b>214,00</b>
<b>CZ-98</b> 09480008	<b>cm. 80x81x5,5h</b>			<b>330,00</b>
<b>CZ-912</b> 09480012	<b>cm. 120x81x5,5h</b>			<b>452,00</b>

## IPERLOTUS 90

MOD. \_\_\_\_\_  
COD. \_\_\_\_\_

DESCRIZIONE/DESCRIPTION/BEZEICHNUNG/DESCRIPTION/DESCRIPCIÓN  
DIMENSIONI/DIMENSIONS/ABMESSUNGEN/DIMENSIONS/DIMENSIONES

POTENZA/POWER/LEISTUNG/PLUISSANCE/POTENCIA  
VOLTAGGIO/VOLTAGE/SPANUNUNG/VOLTAGE/VOLTAJE

kW kcal/h  
kw  
V-  
Hz

PREZZO/PRICE €  
PREIS/PRIX/PRECIO €  
KG / M<sup>3</sup>

- N.B.: BASI REFRIGERATE: SEE SECTION "REFRIGERATED BASES"
- N.B.: refrigerated stand: SEE SECTION "REFRIGERATED BASES"
- N.B.: gekuhilter unterbau: SEE SECTION "REFRIGERATED BASES"
- N.B. soubassement refrigere: SEE SECTION "REFRIGERATED BASES"
- **N.B.: bases refrigeradas: SEE SECTION "REFRIGERATED BASES"**

### MARINE LOTUS



### UK COOKERS



- NUOVE SERIE LOTUS CON LISTINI A PARTE
- New Lotus lines with separate price lists.
  - Neuen Linien Lotus mit anderen Preislisten.
  - Nouvelles lignes LOTUS avec listes de prix à part.
  - **Nuevas series Lotus con los listinos separados.**